



Catalog 2007

**Sioux
Chief**



Download Index



Product Index

Download the Sioux Chief product index in Microsoft® Excel® and Adobe® Acrobat® PDF files at www.siouxchief.com/index

Find Products

Alphabetical Index

Find Sioux Chief products by name, type or description. **p 313**

Numerical Index

Find Sioux Chief products by product number, now includes UPC numbers. **p 317**



Sioux Chief is proud of the contribution it has made to the plumbing industry over the last 50 years. We remain committed to developing new products with the ultimate goal of making plumbing installation easier, more effective, and more efficient.

Proven Performance
99% fill rate
8-hour turn-around in 2006

Less than truckload shipping times
from Peculiar, Mo

Customer Service



Deanna
x324



Michelle
x231



Renea
x223



Gina
x281



Kathy
x280



Ed
x325



John
x268



Wade
x259



Michael
x227



Mike



Mai
x211



Keri
x228



Tracey
x239



Micah
x270



Julie
x312



Mitch
x248



Lilliard
x251



Eric
x326



Derrick
x314



Kris
x250



Evette
x316



Crystal
x210



Peggy
x249

Para servicio en Español favor de marcar la extensión 316.



Joe
x234



Jeff
x321



Brandon
x327



Ethan
x213

Sales

Supply

Fittings and Valves

Sweat Fittings and Valves 11

PEX Fittings and Valves 33

CPVC Fittings and Valves 49

PVC Fittings and Valves 58

Kits

Shower-Up Kits 63

Water Heater Kits 76

Heating Coil Loop Kits 82

Manifolds

Potable Water Manifolds 83

Hydronic Heating Manifolds 89

Arresters & Primers 93

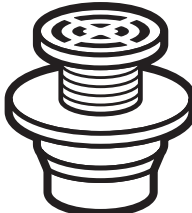

SUPPLY

DRAINAGE

Drainage

Commercial

Commercial On-Grade Drains 109

Commercial Large Capacity Drains 121

Commercial Flashing Drains 127

Commercial Roof Drains 135

Commercial Cleanouts 152

Residential

Residential Shower Drains 153

Residential Floor Drains 159

Residential Closet Flanges 167

Residential Backwater Valve 173

Accessories 175



SUPPORT

TESTING

Support

Supply Hangers 191

DWV Hangers 206

Brackets 210



SPECIALTIES

Testing

Plugs and Caps 225

Gauges 231

Equipment 232

Specialties

Trim 235

Supply 243

DWV 247

Toilet 258

Log Lighter 271



TOOLS

Tools

Saws and Cutters 277

Wrenches 281

Brushes and Abrasives 285

Accessories 289

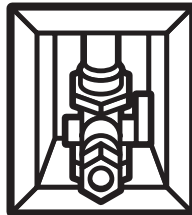

ACCESS

Access

Outlet Boxes 301

Access Panels 310

A Leader in Manufacturing

Since 1957, Sioux Chief has demonstrated its dedication to creative manufacturing and new product development with the ultimate goal of making plumbing installation easier, more effective, and more efficient.

The values upon which Ed Ismert founded Sioux Chief continue to be the driving forces behind the company today: concern for the plumbing tradesman, a culture based on family, and a dedication to continuous improvement.

Sioux Chief creates and manufactures some of the most diverse and innovative plumbing products in the country. We focus on product innovation initiated by field research and interviews with plumbers, engineers, code officials, and distributors.

One of the reasons Sioux Chief is able to turn an idea into a product so quickly is because we design and build our own machines, tools and dies, and equipment to ensure that exact product tolerances are achieved. Process innovation also controls manufacturing costs, providing constant, reliable value to the customer, year after year.

Sioux Chief is proud to be a true American innovator, one that combines the desire to innovate with the capability to make it happen.



Sioux Chief Ten-Year Employees

Helpful Tools

Sioux Chief Prime Products

Look for the  throughout our catalog. You will find it on products that we have developed by listening to the needs of plumbing and mechanical contractors. Whether you are a contractor, wholesaler, or engineer, these products will add value to the work you do. They are the Sioux Chief Prime Products. Ask for them by name.



Web Site

Visit our web site for product information, spec sheets and literature in PDF format, Rep information, catalog and Total Resource CD request, an entire section dedicated to water hammer and industry links.



Total Resource CD

Our Total Resource CD is a handy collection of digital resources that includes our Product Index in Excel and PDF formats, spec sheets and literature in PDF format, line art product graphics, and Sioux Chief logos. To request your free CD visit our web site or call our customer service department.



Merchandising Options

We offer new packaging options that give you the flexibility to present our products in the way that best suits your customers and your business format.

Increase visibility to the Sioux Chief products "hidden" in your warehouse by adding display items at your counter area. Professionally merchandise your self-service areas. Use packaged items to help explain a new, time-saving product or installation method.

We are confident that these packaging options will be a useful tool as you work to better serve the plumbing installer.



Item No.	Copper Type	CTS	Dimensions		Min. Qty.	Case Qty.	List Price
			A	B			
MALE SWEAT							
BULK							
613-57	L	1/2"	5"	7"	50	50	3.79 EA
613-67	L	1/2"	6"	7"	50	50	4.05 EA
613-87	L	1/2"	8"	7"	50	50	4.62 EA
INDIVIDUALLY BAR-CODED IN A CUT CASE BOX							
613-57PK	L	1/2"	5"	7"	20	20	3.94 EA
MALE SWEAT WITH SQUARE O STRAP							
613-57E	L	1/2"	5"	7"	25	25	4.79 EA
613-87E	L	1/2"	8"	7"	25	25	5.62 EA

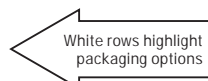
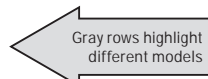



1957 Sioux Chief is born on the third floor of Double I Supply in Kansas City, Kansas.

Ed Ismert becomes Sioux Chief's first, albeit part time, employee.

Operations began by offering an assortment of the basic products residential plumbers would use including specialty pipe hangers and fasteners, closet bolts and multi-sectional magnesium rods for water heaters.

1963
Stub Out



1980
Sioux Strap



1988
Repair Coupling
Sawhorse



1967 Sioux Chief moves to Kansas City, Missouri.

Tub Spout Elbow



1978
Stub Out Elbow



1982
Weld One



1987
Hydra-Rester



1957

1967

1977

1987



1961
Theodore "Ted" Ismert becomes Sioux Chief's first full time employee.

1968
Slip Male Adapter
Long Branch



1981
Tube Talon



1986
BranchMaster
HearthMaster



1974
Plumb
Perfect



1983 Sioux Chief moves to present location in Peculiar, Missouri.

1989
Mini-Rester



1977 Martin E. Ismert's eldest sons Mike and Joe purchase Sioux Chief and take over company operations.



1990
Quad Drain



1992
Stub Air
Twin Talon

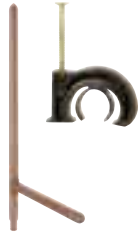

1994
Hangs Tuff



2000
Pipe Eye
Universal Slider Bracket



1997
TouchDown
ZipStick
Grid Iron



2003
Grip Tip
Add-A-Line
Secure-All
Push Tite



2004
Stick-Em Up
Drop Kick
Full Flush
Power Bar



2005
Pick-Up Talon
SideWinder



1997



1993
Test Titan



1995
HearthMaster
Ball Valves



1991
Pipe Titan

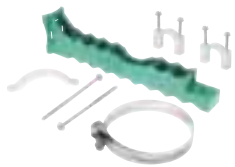

1999
Shower WallNut
TouchDown II
Prime Perfect



1998
PadLock
CPVC Fittings
Suspensulator



2002
Shower-Up
TKO Stainless Ring
Tomahawk

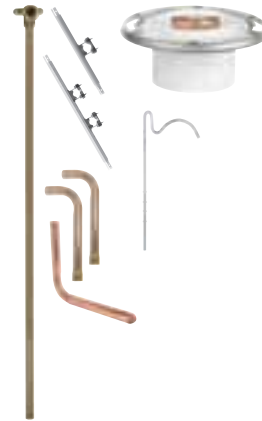

2006
Ox Box
Finish Line
PVC Fittings



1996
TKO
PEX Fittings



2001
Square Max



New Products



◀ **Add-A-Line™**
 • new all brass construction

Ball Valves ▶
 • press-fit compatible brass
 • CPVC
 • PVC

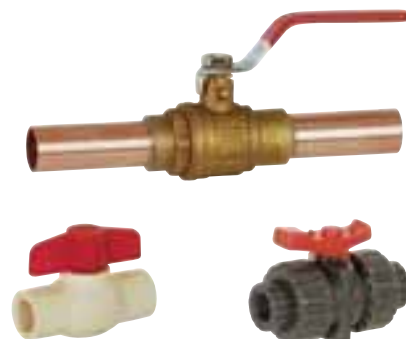

◀ **BranchMaster™**
 • new manifolds for hydronic applications

Mini-Rester™ ▶
 • Three new tub/shower connection models
 • New cold expansion F2080 PEX tee



◀ **Finish Line™** ▶
 • On-grade drains, flashing drains, and cleanouts that are adjustable AFTER the pour



Fat Max™ ▶
 • new stainless steel model

◀ **Closet Flanges**
 • 36 new models



New Products



- ◀ Pipe Eye™
- glueable model

- ▶ TouchDown™
- ▶ TouchDown II™
- with beam clip



- ◀ Power Bar™
- new shorter models

- ▶ Chase Bracket
- with or without band



- ◀ Mechanical Test Plug

- ▶ Smart Cap™
- cover closet bolts



- ◀ Tools
- tube cutters
- wrenches
- levels
- flaring tools
- hex keys
- deburring tools



Try Me Packs

See the Numerical Index in the back of this catalog to find which items are available as Try Me Packs.



Terms and Conditions

The following terms and conditions pertain to qualified customers only. Sioux Chief, at its option, may qualify or disqualify any customer.

Terms Credit Terms: 2% 30, Net 45.

Sioux Chief will credit qualified customers 2% for full payment of invoices made on or before the 30th day following the date of invoice; invoices will become due on the 45th day following the date of invoice. A monthly service charge of 1.5% will be applied to all overdue accounts. Accounts that regularly pay beyond net terms will be denied open account status.

Full Freight Allowance Sioux Chief will pay freight on all orders to single destinations totaling at least \$2,500 list price to locations within the 48 contiguous states (United States of America), at least \$3,500 list price to locations within Hawaii, Alaska, and Canada and at least \$4,500 list price to locations within Puerto Rico.

Returned Goods and Warranty Service In order to return product or receive warranty service, customers must obtain a Return Goods Authorization (RGA) by contacting Sioux Chief Manufacturing using the following information: MAIL: Customer Service Manager, Sioux Chief Manufacturing Company, Inc., P.O. Box 397, Pecu- liar, Missouri 64078; phone: 816-779-6104; fax: 816-758-5950; email: info@siouxchief.com.

Sioux Chief will not receive product without a Sioux Chief issued RGA number. In order to be processed, all RGA requests must reference our order number, our invoice number or the customer's P.O. number, which must be less than twelve months old. In order to be received, all returned material must be in multiples of the stated catalog minimum order quantity and in original condition. Specials or custom-made products are not considered normal stock and therefore cannot be returned, except in case of manufacturer's defect. Customers will be charged 25% of invoice price for product restocking. An RGA is invalid if referenced product is not received within 90 days of an RGA issue date. Issuance of the RGA does not authorize the customer to deduct the value of the return; once product is received by Sioux Chief and found to be in acceptable condition, Sioux Chief will issue a credit memo for returned product and related expenses (i.e. shipping) when applicable. Sioux Chief reserves the right to deny, nullify or cancel an RGA at its discretion.

Prices All prices are subject to change without notice.

Minimum Order Quantities A 10% surcharge will be applied to any item NOT purchased in multiples of the stated Minimum Quantity, except on drop ship orders. Items with bold Minimum Quantities in the Numerical Index (back of catalog) can NEVER be broken.

Shipping Errors Sioux Chief will not be responsible for shipping errors reported 10 days after receipt of material.

Shipping Shortages Sioux Chief will not be responsible for shipment shortages that are signed for as clear.

Additions and Changes While we will always make every effort to ship our product according to your specific instructions, additions or changes to your orders may reach us too late to be implemented. We ship most orders within one working day.

Sioux Chief makes no assurances as to code or standards conformance of our product other than what is printed in this catalog, on original Sioux Chief literature or web site, in Sioux Chief paid advertising or identified directly on the product itself. Check with your local Sioux Chief sales representative, code official or call the factory for current code and standards conformance information on our products.

Lifetime Warranty

Sioux Chief Manufacturing Company, Inc. warrants that products manufactured by it will be free from defects in material and workmanship during the lifetime of the plumbing system in which they were originally incorporated and will, at its option, repair, replace, or supply credit to any purchaser of any product that appears, to the Company's satisfaction, to have been defective in material or workmanship and covered by the Company's warranty.

This warranty shall be effective **only if** the product (1) was installed in accordance with supplied instructions, common installation or use practices and existing building and plumbing codes, (2) has not been subjected to misuse or abuse, (3) was at all times used in a manner consistent with its intended use, (4) was never modified, altered, or repaired by anyone other than Sioux Chief, and (5) was properly subjected to and passed applicable testing methods (including pressure testing for potable water and drainage systems) **immediately** after the product's installation, (6) was not damaged by freezing, corrosion or U.V. degradation and (7) was never damaged or materially changed by an uncontrollable, outside influence or natural phenomenon. This warranty excludes all costs arising from routine maintenance, including the replacement of any parts required by such maintenance and the replacement of parts required by normal wear and tear. This warranty does not obligate Sioux Chief to bear any transportation, removal or installation charges in connection with the inspection, repair or replacement of defective parts, other than the cost or cost-equivalent of the defective Sioux Chief-manufactured product. Sioux Chief also reserves the right to modify, alter or improve their product,

or parts thereof, at any time without incurring an obligation to notify or modify, alter, improve or replace any product, or parts thereof, previously sold. This warranty is the purchaser's exclusive remedy.

THE WARRANTY PRINTED ABOVE IS THE ONLY WARRANTY APPLICABLE TO THIS PURCHASE. ANY EXPRESS WARRANTY NOT PROVIDED HEREIN, AND ANY REMEDY WHICH BUT FOR THE WARRANTY CONTAINED HEREIN MIGHT ARISE BY IMPLICATION OR OPERATION OF LAW, IS HEREBY EXCLUDED AND DISCLAIMED INCLUDING THE IMPLIED WARRANTIES OF MERCHANTABILITY AND OF FITNESS FOR A PARTICULAR PURPOSE. SOME STATES DO NOT ALLOW LIMITATIONS ON IMPLIED WARRANTIES, SO THE ABOVE LIMITATION MAY NOT APPLY TO YOU. IT IS UNDERSTOOD AND AGREED THAT SELLER'S LIABILITY AND PURCHASER'S SOLE REMEDY, WHETHER IN CONTRACT, UNDER ANY WARRANTY, IN TORT (INCLUDING NEGLIGENCE, IN STRICT LIABILITY OR OTHERWISE SHALL NOT EXCEED THEIR RETURN OF THE AMOUNT OF THE PURCHASE PRICE PAID BY THE PURCHASER, AND UNDER NO CIRCUMSTANCES SHALL SELLER BE LIABLE FOR ANY SPECIAL, INCIDENTAL OR CONSEQUENTIAL DAMAGES, INCLUDING, BUT NOT LIMITED TO, PERSONAL PROFITS OR REVENUE, COSTS OF RENTING REPLACEMENTS AND OTHER ADDITIONAL EXPENSES, EVEN IF SELLER HAS BEEN ADVISED OF THE POSSIBILITY OF SUCH DAMAGES. THE PRICE STATED FOR THE PRODUCT IS A CONSIDERATION IN LIMITED SELLER'S LIABILITY. SOME STATES DO NOT ALLOW THE EXCLUSION OR LIMITATION OF INCIDENTAL OR CONSEQUENTIAL DAMAGES, SO THE ABOVE LIMITATION OR EXCLUSION MAY NOT APPLY TO YOU. SELLER WILL NOT BE LIABLE FOR ANY DAMAGES, LOSSES OR EXPENSES AS A RESULT OF PURCHASERS NEGLIGENCE, WHETHER DEEMED ACTIVE OR PASSIVE AND WHETHER OR NOT ANY SUCH NEGLIGENCE IS THE SOLE CAUSE OF ANY SUCH DAMAGE, LOSS OR EXPENSE. THIS WARRANTY GIVES YOU SPECIFIC LEGAL RIGHTS, AND YOU MAY HAVE OTHER RIGHTS, WHICH VARY FROM STATE TO STATE.

Supply

Fittings & Valves

Sweat

PEX

CPVC

PVC

Kits

Shower-Up

Water Heater

Tankless Water Heater

Heating Coil Loop

Manifolds

Potable Water

Hydronic Heating

Arresters & Primers

Water Hammer Arresters

Trap Primers



FITTINGS AND VALVES

Sweat

- 13-15 Bullet™
- 15-16 Stub Out Elbow
 - 16 Double Stub Out Elbow
 - 17 Tub Spout Elbow
 - 18 Offset Tub Spout Elbow
 - 18 Stub Air™
 - 19 Tub/Shower Pressure Connector
 - 19 Shower Riser Fitting
 - 20 Offset Riser Fitting
 - 20 Tub/Shower Elbows
- 20-22 Water Heater Connector
- 23 Dielectric Connector
- 23 Heat Trap Loop
- 23 Water Heater Stub Out Loop
- 24 Termination Fitting
- 24 Wal-Let™
- 24 Water Service Connectors
- 25 Replace-A-Valve™
- 25 Full-Slip Repair Couplings
- 26 Plated Stub Out Sleeves
- 26 Pre-Cut Copper Nipples
- 26-27 Full-Slip Male Adapter
- 27-28 Add-A-Line™
 - 29 Brass Ball Valve
 - 29 Brass Stop & Waste Valve
 - 30 Brass Boiler Drain
 - 30 Sillcock
 - 31 Frost-Proof Anti-Siphon Sillcock
 - 32 Frost-Proof Sillcock Replacement Parts
 - 32 Vacuum Breaker
 - 32 Standard Supply Stop

PEX

- 34 PEX Crimp Ring
- 34 Stub Out Elbow
- 35 Bullet™
- 35 Stub Air™
- 36 Tub/Shower Pressure Connector
- 36 Tub/Shower Elbow
- 37-38 Water Heater Connector
- 39 Water Heater Stub Out Loop
- 39 Valved Service Loop
- 39 Coupling
- 40 Tee
- 40 Elbow
- 41 Test Plug
- 41-43 Straight Adapter
- 43-44 Elbow Adapter
 - 44 Tee Adapter
 - 45 Ballcock Adapter
 - 45 Faucet Adapter
 - 45 Dishwasher Elbow
 - 46 Brass Ball Valve
 - 46 Brass Stop & Waste Valve
 - 46 ¼-Turn Sillcock
 - 47 Frost-Proof Anti-Siphon Sillcock
 - 47 Ice Maker Valve
 - 47 Standard Supply Stop
 - 48 Polybutylene Fittings
 - 48 Polybutylene Tees

Supply

CPVC

- 50 Stub Out Elbow
- 51 Tub/Shower Pressure Connector
- 51 Tub/Shower Elbow
- 52-53 Water Heater Connector
- 54 Wal-Let™
- 54-56 Adapter
 - 54 Short-N-Swivel™
 - 56 Brass Ball Valve
 - 57 Thermoplastic CPVC Ball Valve
 - 57 Brass Stop & Waste Valve
 - 57 Brass Boiler Drain
 - 57 Sillcock

PVC

- 60 PVC Adapter
- 60 Brass Ball Valve
- 61 ThermoPlastic Ball Valve
- 61 PVC Double Union Ball Valve

KITS**Shower-Up™**

- Copper System
- 65 Male Sweat Connection
- 66 MIP Connection
- 67 FIP Connection
 - PEX System
- 69 Sweat Connection
- 70 MIP Connection
- 71 FIP Connection
 - CPVC System
- 73 Sweat Connection
- 74 MIP Connection
- 75 FIP Connection

Water Heater Connector

- 76 Copper System
- 78 PEX System
- 80 CPVC System
- 82 Tankless Water Heater

Heating Coil Loop Connector

- 82 Heating Coil Loop Connector

MANIFOLDS**Potable Water**

- BranchMaster™
- 85 ⅜" PEX Branches
- 85 ½" PEX Ball Valve Branches
- 86 ½" PEX Branches
- 87 Mixed PEX Branches
- 87 Male Sweat Branches
- 87 ¾" Female Sweat Branches
- 88 ½" MIP/Female Sweat Ball Valve Branches
- 88 ½" MIP Branches

Hydronic Heating

- BranchMaster™
- 89 ½" Male Sweat Branches
- 90 ½" MIP Branches
- 90 ½" MIP/Female Sweat Branches
- 90 ½" PEX F1807 Branches
- 91 ½" ComPEX Branches
- 91 ½" R20 Branches
- 91 Manifold Endpiece

ARRESTERS & PRIMERS**Water Hammer Arresters**

- 94-97 Mini-Rester™
- 98 Hydra-Rester®
- 100 Mega-Rester™
- 102 Vacu-Rester™

Trap Primers

- 103 Prime Perfect™
- 104 Splitters
- 104 Trap-Ease™

Fittings & Valves

Sweat
PEX
CPVC
PVC

SUPPLY

DRAINAGE

SUPPORT

TESTING

SPECIALTIES

TOOLS

ACCESS



SUPPLY

DRAINAGE

SUPPORT

TESTING

SPECIALTIES

TOOLS

ACCESS



Rough-in Ready™ Preformed Copper Fittings

- All Sioux Chief Rough-in Ready preformed copper fittings for sweat are made in the USA from 100% pure copper tube that conforms to these specifications. Tube: ASTM B 88 and Fitting Ends: ANSI B16.22
- Spin closed ends eliminate the need to solder on caps.
- Stub out elbows eliminate an elbow and cap.
- Square O Straps are crimped onto tube for solid attachment to bracket or stud.
- Full-slip fittings are great for repair jobs or new construction.

Important Notes about Sioux Chief Male Sweat Fittings

- All Sioux Chief male sweat fittings are compatible with press-fit fitting systems, such as Ridgid-Viega ProPress™ and all push-fit fitting systems such as Cash Acme SharkBite®.

**PRESS-FIT
COMPATIBLE**



- Spin closed ends and preformed elbows reduce the number expensive press-fit caps and elbows used on a job.

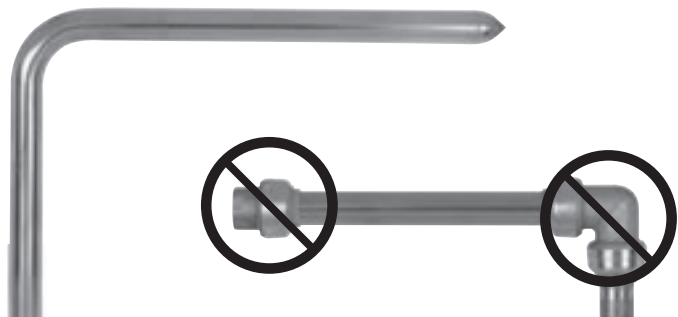

Bullet™ Stub Out & Air Chamber

- Reduce job-site and shop costs such as measuring, cutting, cleaning, fluxing, assembling, and soldering
- Precision spin closed ends are guaranteed leakproof
- Turn your variable job site costs into fixed job costs
- We can make 1 ¼"–2" CTS Bullets. Call us for a quote
- Press-fit compatible

Polished Nickel Plated

- Eliminates the need for sleeving or tinning
- Solders with standard flux and solder

Bracketed Stub Out

- Perfect for stubbing up through the floor for closets or lavs
- Square O Strap is crimped to tube 12" from each end

Item No.	Copper Type	CTS	Length	Min. Qty.	Case Qty.	List Price
STANDARD						
BULK						
622-M06	M	½"	6"	100	100	1.47 EA
622-M08	M	½"	8"	100	100	1.89 EA
622-M10	M	½"	10"	100	100	2.47 EA
622-M12	M	½"	12"	100	100	2.72 EA
622-M15	M	½"	15"	100	100	3.34 EA
622-M18	M	½"	18"	100	100	4.03 EA
622-M24	M	½"	24"	50	50	5.60 EA
623-M06	M	¾"	6"	50	50	3.18 EA
623-M08	M	¾"	8"	50	50	3.96 EA
623-M12	M	¾"	12"	50	50	5.70 EA
622-L06	L	½"	6"	100	100	1.88 EA
622-L08	L	½"	8"	100	100	2.43 EA
622-L10	L	½"	10"	100	100	3.19 EA
622-L12	L	½"	12"	100	100	3.58 EA
622-L15	L	½"	15"	100	100	4.52 EA
622-L18	L	½"	18"	100	100	5.26 EA
622-L24	L	½"	24"	50	50	7.18 EA
623-L06	L	¾"	6"	50	50	4.00 EA
623-L08	L	¾"	8"	50	50	5.06 EA
623-L12	L	¾"	12"	50	50	7.32 EA
623-L15	L	¾"	15"	50	50	8.96 EA
623-L18	L	¾"	18"	50	50	10.29 EA
623-L24	L	¾"	24"	50	50	15.23 EA
624-L08	L	1"	8"	30	30	7.44 EA
624-L12	L	1"	12"	30	30	10.70 EA
624-L15	L	1"	15"	30	30	13.17 EA
624-L18	L	1"	18"	30	30	15.08 EA
624-L24	L	1"	24"	30	30	20.92 EA
INDIVIDUALLY BAR-CODED IN A CUT CASE BOX						
622-M08PK	M	½"	8"	100	100	2.03 EA
622-M12PK	M	½"	12"	100	100	2.86 EA
622-L06PK	L	½"	6"	100	100	2.02 EA
622-L08PK	L	½"	8"	100	100	2.57 EA
NICKEL PLATED						
622-L08N	—	½"	8"	25	25	5.85 EA
BRACKETED						
622-L24E	L	½"	24"	20	20	8.18 EA



622-M08



622-L08N



622-L24E



Bullets save time and reduce on-the-job costs. Perfect for any stub out or air chamber application.

Guaranteed Leakproof
Spin closed ends have **five** times the wall thickness of the copper tube. Each fitting is factory inspected.



SUPPLY

DRAINAGE

SUPPORT

TESTING

SPECIALTIES

TOOLS

ACCESS

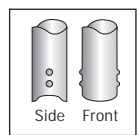
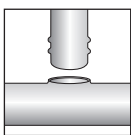

Be sure dimples on Bullet connection are in-line with trunk line.

Bullet™ Dimple & Notch Stub Out

- Use with T-Drill® extrusion-type tees
- Double dimples meet code requirements
- Guaranteed leakproof

Item No.	Copper Type	CTS	Length	Min. Qty.	Case Qty.	List Price
623-L08D	L	3/4"	8"	50	50	6.83 EA
623-L12D	L	3/4"	12"	50	50	8.09 EA
623-L18D	L	3/4"	18"	50	50	11.28 EA
623-L24D	L	3/4"	24"	50	50	16.10 EA
624-L08D	L	1"	8"	30	30	8.54 EA
624-L12D	L	1"	12"	30	30	12.74 EA
624-L18D	L	1"	18"	30	30	17.08 EA
624-L24D	L	1"	24"	30	30	22.24 EA



T-Drill® is a registered trademark of T-Drill Industries

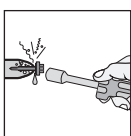

5/16" galvanized steel hex head screw, with built in gasket allows for bleedable waterline tests.

Bullet™ Wet Test Stub Out

- Perfect for double-checking crossed hot and cold water lines
- Excellent way to flush lines before testing



PRESS-FIT COMPATIBLE

Item No.	Copper Type	CTS	Length	Min. Qty.	Case Qty.	List Price
622-L08W	L	1/2"	8"	100	100	3.91 EA

Bullet™ 1/2" MIP Stub Out

- Use permanently, or for temporary tub/shower valve stub out test
- Lead-free solder joint

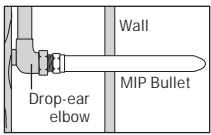
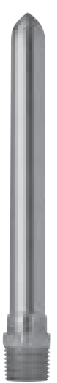

Perfect for tub spout nipples.

Item No.	CTS	Length	Min. Qty.	Case Qty.	List Price
BULK					
614-6M	1/2"	6 1/2"	50	50	4.09 EA
614-8L	1/2"	8 1/2"	50	50	5.11 EA
INDIVIDUALLY BAR-CODED IN A CUT CASE BOX					
614-6MPK	1/2"	6 1/2"	50	50	4.23 EA



Bullet™ Reducing Air Chamber

- Extra large volume air chamber is spin reduced for 1/2" male sweat connection

Item No.	Copper Type	CTS	Length	Min. Qty.	Case Qty.	List Price
STANDARD						
629-M	M	3/4"	13 1/2"	50	50	6.27 EA
629-06	M	1"	6"	100	100	4.27 EA
629-12	M	1"	12"	50	50	7.43 EA
629-L15	L	3/4"	15"	50	50	10.11 EA
OLD WISCONSIN CODE PATTERN						
BULK						
629-WCM	M	1"	14"	50	50	9.29 EA
629-WCL	L	1"	14"	50	50	11.94 EA
INDIVIDUALLY BAR-CODED IN A CUT CASE BOX						
629-WCMPK	M	1"	14"	50	50	9.43 EA



Stub Out Elbow

Male Sweat

- A stub out, cap and elbow in one full flow fitting—an even better time saver than our straight stub outs
- Tight radius, full flow bends with no thinning of the tube wall
- Perfect for use in 2 x 4 walls
- Press-fit compatible



Item No.	Copper Type	CTS	Dimensions			Min. Qty.	Case Qty.	List Price
			A	B	C			
MALE SWEAT								
BULK								
608-L246	L	1/2"	3 1/2"	6"	1 1/4"	50	50	2.98 EA
608-L248	L	1/2"	3 1/2"	8"	1 1/4"	50	50	3.50 EA
608-L2612	L	1/2"	6"	12"	1 1/4"	50	50	5.81 EA
608-L2812	L	1/2"	8"	12"	1 1/4"	50	50	6.35 EA
608-L2138	L	1/2"	13"	8"	1 1/4"	50	50	6.43 EA
608-L2187	L	1/2"	18"	7"	1 1/4"	50	50	7.68 EA
608-L2277	L	1/2"	27"	7"	1 1/4"	50	50	11.00 EA
608-L2337	L	1/2"	33"	7"	1 1/4"	50	50	13.37 EA
608-L348	L	3/4"	4"	8"	1 3/4"	50	50	7.36 EA
608-L3612	L	3/4"	6"	12"	1 3/4"	50	50	11.27 EA
608-L3812	L	3/4"	8"	12"	1 3/4"	50	50	12.28 EA
608-L4612	L	1"	6"	12"	2"	25	25	17.51 EA
608-L4812	L	1"	8"	12"	2"	25	25	18.70 EA
INDIVIDUALLY BAR-CODED IN A CUT CASE BOX								
608-L246PK	L	1/2"	3 1/2"	6"	1 1/4"	50	50	3.12 EA
608-L248PK	L	1/2"	3 1/2"	8"	1 1/4"	50	50	3.64 EA

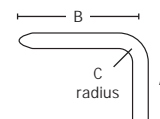

SUPPLY
DRAINAGE
SUPPORT
TESTING
SPECIALTIES
TOOLS
ACCESS

SUPPLY

DRAINAGE

SUPPORT

TESTING

SPECIALTIES

TOOLS

ACCESS

Stub Out Elbow

Female Sweat with Square O Strap

- A stub out, cap and elbow in one full flow fitting—an even better time saver than our straight stub outs
- Tight radius, full flow bends with no thinning of the tube wall
- Perfect for use in 2 × 4 walls
- Square O Strap is crimped onto tube for solid attachment to bracket or stud



609-L246

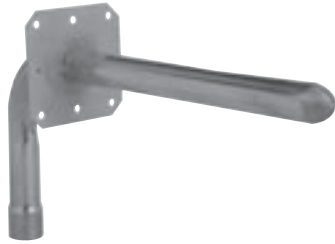

609-L246E

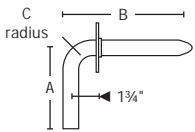

Item No.	Copper Type	CTS	Dimensions			Min. Qty.	Case Qty.	List Price
			A	B	C			
FEMALE SWEAT								
609-L246	L	1/2"	3 1/2"	6"	1 1/4"	50	50	3.17 EA
609-L248	L	1/2"	3 1/2"	8"	1 1/4"	50	50	3.62 EA
609-L2612	L	1/2"	6"	12"	1 1/4"	50	50	6.05 EA
609-L2812	L	1/2"	8"	12"	1 1/4"	50	50	6.63 EA
609-L2138	L	1/2"	13"	8"	1 1/4"	50	50	6.76 EA
609-L3248	L	1/2" tube 3/4" FSWT	4"	8"	1 1/4"	50	50	4.16 EA
609-L348	L	3/4"	4"	8"	1 3/4"	50	50	8.21 EA
609-L3612	L	3/4"	6"	12"	1 3/4"	50	50	11.80 EA
609-L3812	L	3/4"	8"	12"	1 3/4"	50	50	12.57 EA
609-L4612	L	1"	6"	12"	2"	25	25	18.00 EA
609-L4812	L	1"	8"	12"	2"	25	25	19.28 EA
FEMALE SWEAT WITH SQUARE O STRAP								
609-L246E	L	1/2"	3 1/2"	6"	1 1/4"	25	25	4.17 EA
609-L248E	L	1/2"	3 1/2"	8"	1 1/4"	25	25	4.62 EA



Double Stub Out Elbow

- Brazed bottom stub out joint will not fracture
- Square O Strap is crimped to tube



Perfect for running sink and dishwasher supplies, (hot side) or sink and ice maker supplies, (cold side) off the same branch line.

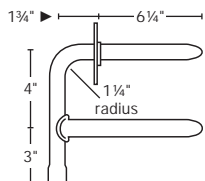

Item No.	Copper Type	CTS	Min. Qty.	Case Qty.	List Price
608-D288E	L	1/2"	25	25	12.23 EA
FEMALE SWEAT					
609-D288E	L	1/2"	25	25	12.58 EA



Tub Spout Elbow

Male Sweat
with Square O Strap
with Wall Block Plate

- Connect tub valve to spout nipple in one easy step
- 1 ¼" radius fits all valve rough-ins
- Square O strap and Wall Block are crimped to tube

MIP Swivel

- No soldering with easy swivel thread installation
- 1 ¼" radius fits all valve rough-ins

Fixed MIP
with Wall Block Plate

- No soldering with male thread connection
- 1 ¼" radius fits all valve rough-ins

FIP Swivel

- No soldering with easy swivel thread installation
- 1 ¼" radius fits all valve rough-ins

Item No.	Copper Type	CTS	Dimensions		Min. Qty.	Case Qty.	List Price
			A	B			
MALE SWEAT							
BULK							
613-57	L	½"	5"	7"	50	50	3.79 EA
613-67	L	½"	6"	7"	50	50	4.05 EA
613-87	L	½"	8"	7"	50	50	4.62 EA
613-107	L	½"	10"	7"	50	50	5.43 EA
613-137	L	½"	13"	7"	50	50	6.30 EA
613-139	L	½"	13"	9"	50	50	6.85 EA
INDIVIDUALLY BAR-CODED IN A CUT CASE BOX							
613-57PK	L	½"	5"	7"	20	20	3.94 EA
MALE SWEAT WITH SQUARE O STRAP							
613-57E	L	½"	5"	7"	25	25	4.79 EA
613-87E	L	½"	8"	7"	25	25	5.62 EA
MALE SWEAT WITH WALL BLOCK							
612-57	L	½"	5"	7"	25	25	4.73 EA
612-87	L	½"	8"	7"	25	25	5.72 EA
612-108	L	½"	10"	8"	25	25	6.86 EA
MIP SWIVEL							
613-57X	L	½"	5"	7"	50	50	7.23 EA
613-67X	L	½"	6"	7"	50	50	7.27 EA
613-87X	L	½"	8"	7"	50	50	8.18 EA
MIP							
613-57M	L	½"	5½"	7"	50	50	6.37 EA
613-67M	L	½"	6½"	7"	50	50	6.58 EA
613-87M	L	½"	8½"	7"	50	50	7.09 EA
MIP WITH WALL BLOCK							
612-557	L	½"	5½"	7"	25	25	7.17 EA
FIP SWIVEL							
613-57Y	L	½"	5"	7"	50	50	6.12 EA
613-67Y	L	½"	6"	7"	50	50	6.15 EA
613-87Y	L	½"	8"	7"	50	50	7.13 EA

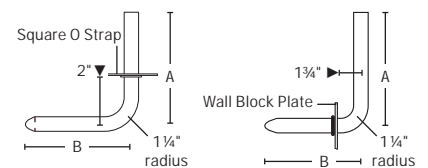
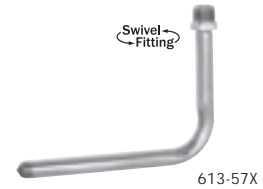
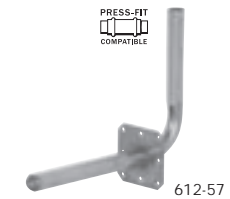

SUPPLY

DRAINAGE

SUPPORT

TESTING

SPECIALTIES

TOOLS

ACCESS

SUPPLY

DRAINAGE

SUPPORT

TESTING

SPECIALTIES

TOOLS

ACCESS

Offset Tub Spout Elbow

Male Sweat

- Use right offset model for right-handed tub/shower installation
- Great for ADA applications



613-887R

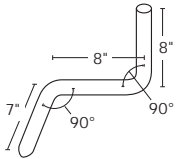

Item No.	Copper Type	CTS	Offset Direction	Min. Qty.	Case Qty.	List Price
613-887L	L	1/2"	left	25	25	8.33 EA
613-887R	L	1/2"	right	25	25	8.33 EA

Stub Air™

Air Chamber Tee Fitting

- Turns variable job-to-job costs like measuring, cutting, cleaning, fluxing, and soldering of up to four joints into fixed costs
- Sturdy, fracture resistant brazed saddle joint will not be damaged during field soldering
- Optional branch length, branch end, and trunk size for many different job site applications
- Guaranteed leakproof



683-M5113



682-M5140



Test-ready stub outs and air chambers, with only ONE solder joint needed.



Models with open branches work great for tub valve connections.

Item No.	Copper Type	CTS	Branch		Air Chamber		Min. Qty.	Case Qty.	List Price
			CTS	Length	CTS	Length			
OPEN BRANCH									
682-L5113	L	1/2"	1/2"	1 1/2"	1/2"	12"	25	25	9.77 EA
682-M5113	M	1/2"	1/2"	1 1/2"	1/2"	12"	25	25	8.55 EA
683-M5113	M	1/2"	1/2"	1 1/2"	3/4"	12"	25	25	11.57 EA
SPIN CLOSED									
682-L5140	L	1/2"	1/2"	8"	1/2"	12"	25	25	11.68 EA
682-M5140	M	1/2"	1/2"	8"	1/2"	12"	25	25	10.52 EA
683-M5140	M	1/2"	1/2"	8"	3/4"	12"	25	25	13.67 EA



Tub/Shower Pressure Connector

- Long radius bend for better flow and less noise
- MIP and FIP connections mean no soldering
- Easy swivel thread installation

Item No.	Connection	Dimensions			Min. Qty.	Case Qty.	List Price
		A	B	C			
609-L263A	1/2" male sweat x 1/2" female sweat	2 1/4"	6"	1 1/4"	50	50	3.18 EA
609-L27	1/2" male sweat x 1/2" female sweat	1 1/2"	7"	1"	50	50	4.86 EA
609-L263X	1/2" MIP swivel x 1/2" female sweat	3"	6"	1 1/4"	50	50	6.65 EA
609-L263Y	1/2" FIP swivel x 1/2" female sweat	3"	6"	1 1/4"	50	50	5.47 EA

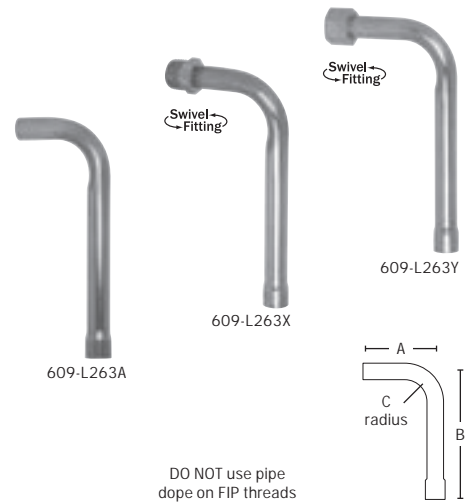

Shower Riser Fitting

- Male Sweat Connection
- MIP Swivel Connection
- FIP Swivel Connection

- Sweat into standard tub/shower valves
- MIP and FIP swivel means no soldering
- Made from Type L copper tube (except 616-648, Type M)
- Square O strap is crimped onto tube

Related Products
Shower WallNut p 241

Item No.	Connection	Square O Strap	Length	Min. Qty.	Case Qty.	List Price
MALE SWEAT						
616-630	1/2" male sweat x drop-ear		30"	50	50	15.31 EA
616-648	1/2" male sweat x drop-ear		48"	12	12	18.74 EA
616-650	1/2" male sweat x drop-ear		50"	25	25	20.37 EA
608-L2308	1/2" male sweat x stub out elbow		30"	25	25	13.31 EA
608-L2488	1/2" male sweat x stub out elbow		48"	25	25	18.45 EA
608-L2508	1/2" male sweat x stub out elbow		50"	25	25	19.19 EA
608-L2308E	1/2" male sweat x stub out elbow	✓	30"	25	25	14.31 EA
608-L2488E	1/2" male sweat x stub out elbow	✓	48"	25	25	19.45 EA
608-L2508E	1/2" male sweat x stub out elbow	✓	50"	25	25	20.19 EA
MIP SWIVEL						
616-630X	1/2" MIP swivel x drop-ear		30"	50	50	19.10 EA
616-650X	1/2" MIP swivel x drop-ear		50"	25	25	24.19 EA
608-L2308X	1/2" MIP swivel x stub out elbow		30"	25	25	16.39 EA
608-L2508X	1/2" MIP swivel x stub out elbow		50"	25	25	22.48 EA
608-L2308EX	1/2" MIP swivel x stub out elbow	✓	30"	25	25	17.39 EA
608-L2508EX	1/2" MIP swivel x stub out elbow	✓	50"	25	25	23.48 EA
FIP SWIVEL						
616-630Y	1/2" FIP swivel x drop-ear		30"	50	50	17.82 EA
616-650Y	1/2" FIP swivel x drop-ear		50"	25	25	22.90 EA
608-L2308Y	1/2" FIP swivel x stub out elbow		30"	25	25	15.87 EA
608-L2508Y	1/2" FIP swivel x stub out elbow		50"	25	25	22.54 EA
608-L2308EY	1/2" FIP swivel x stub out elbow	✓	30"	25	25	16.87 EA
608-L2508EY	1/2" FIP swivel x stub out elbow	✓	50"	25	25	23.54 EA

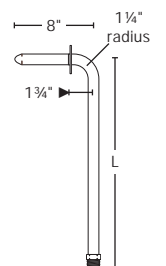
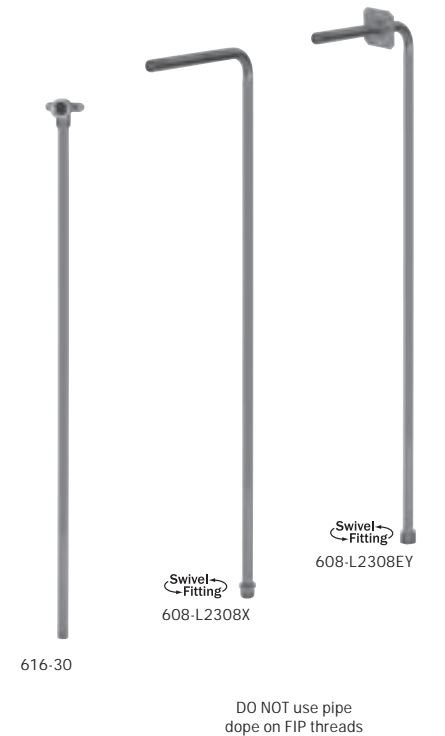

SUPPLY

DRAINAGE

SUPPORT

TESTING

SPECIALTIES

TOOLS

ACCESS

Offset Riser Fitting

- Saves three solder joints
- Made from Type L copper tube

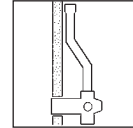
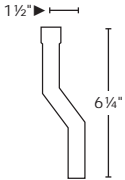

For connecting a pressure balancing valve, which requires an offset, to the shower riser in one simple fitting.

Item No.	Connection	Min. Qty.	Case Qty.	List Price
616-15	1/2" male sweat x 1/2" female sweat	25	25	3.14 EA

Tub/Shower Elbows

Shower-lock & Drop-ear Models

- Drop-ear elbow is heavy-duty forged brass
- Locknut threads on shower-lock model can be trimmed after installation



616-2



616-2E

Item No.	Description	Min. Qty.	Case Qty.	List Price
SHOWER-LOCK				
BULK				
616-2	1/2" female sweat x 1/2" FIP	50	50	8.67 EA
BAR-CODED BAGS IN A CUT CASE BOX				
616-2PK2	1/2" female sweat x 1/2" FIP, 1/bag	10	10	9.65 BG
DROP-EAR				
616-2E	1/2" female sweat x 1/2" FIP	50	50	3.78 EA



Water Heater Connector

FIP x Female Sweat Elbow Fitting

- Brass full-port ball valve available
- Brass FIP swivel nut includes EPDM gasket

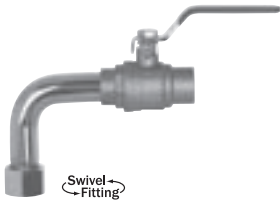

DO NOT use pipe dope on FIP threads

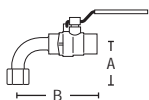

Item No.	Kit Code	Connection	Dimensions		Ball Valve	Min. Qty.	Case Qty.	List Price
			A	B				
631-305FP	01	3/4" FIP swivel x 3/4" FSWT	3"	5"	✓	25	25	21.82 EA
631-33F	41	3/4" FIP swivel x 3/4" FSWT	3"	3"		25	25	7.04 EA

Water Heater Connector

FIP × Full-Slip Female Sweat Straight Fitting

- Full-slip fitting has no stop, slides over tube for easy installation
- Brass FIP swivel nut includes EPDM gasket
- New 1/2" full-slip models for repair jobs

Item No.	Kit Code	Length	Connection	Ball Valve	Min. Qty.	Case Qty.	List Price
633-212	81	12"	3/4" FIP swivel × 1/2" full-slip FSWT		10	10	7.34 EA
633-312	21	12"	3/4" FIP swivel × 3/4" full-slip FSWT		25	25	11.31 EA
633-4312	22	12"	1" FIP swivel × 3/4" full-slip FSWT		25	25	17.77 EA
633-212FP	82	12"	3/4" FIP swivel × 1/2" full-slip FSWT	✓	10	10	16.87 EA
633-312FP	11	12"	3/4" FIP swivel × 3/4" full-slip FSWT	✓	25	25	24.98 EA
633-4312FP	12	12"	1" FIP swivel × 3/4" full-slip FSWT	✓	25	25	34.14 EA

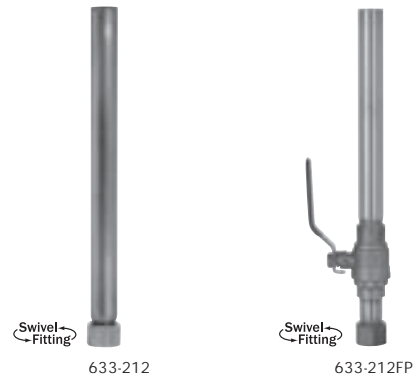

DO NOT use pipe dope on FIP threads

FIP × Full-Slip Compression Straight Fitting

- Full-slip 7/8" compression fitting
- Full port ball valve available
- Brass FIP swivel nut includes EPDM gasket

Item No.	Kit Code	Length	Connection	Ball Valve	Min. Qty.	Case Qty.	List Price
633-312C	23	12"	3/4" FIP swivel × 7/8" compression		25	25	18.23 EA
633-312CFP	13	12"	3/4" FIP swivel × 7/8" compression	✓	25	25	33.79 EA



DO NOT use pipe dope on FIP threads

FIP × FIP Swivel Flexible Fitting FIP × Female Sweat Flexible Fitting

- Flexible copper fitting provides easy connection
- Brass FIP swivel nut includes EPDM gasket

Item No.	Kit Code	Length	Connection	Min. Qty.	Case Qty.	List Price
634-115	—	15"	3/4" FIP swivel × 3/4" FIP swivel	25	25	10.22 EA
634-118	—	18"	3/4" FIP swivel × 3/4" FIP swivel	25	25	11.17 EA
634-315	—	15"	3/4" FIP swivel × 3/4" FSWT	25	25	10.22 EA
634-318	—	18"	3/4" FIP swivel × 3/4" FSWT	25	25	11.21 EA

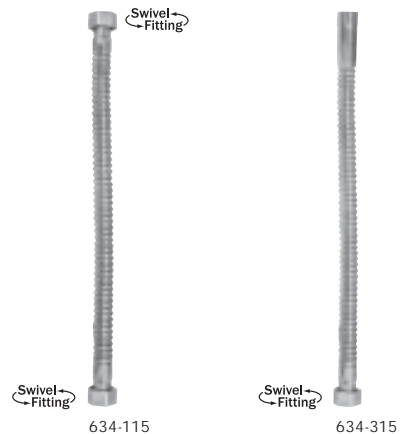

DO NOT use pipe dope on FIP threads

SUPPLY

DRAINAGE

SUPPORT

TESTING

SPECIALTIES

TOOLS

ACCESS

Water Heater Connector

MIP × Full-Slip Female Sweat Fitting

- Full-slip fitting has no stop, slides over tube for easy installation
- Brass full-port ball valve available



646-312



646-312FP



Item No.	Kit Code	Length	Connection	Ball Valve	Min. Qty.	Case Qty.	List Price
646-312	61	12"	3/4" MIP × 3/4" full-slip FSWT		25	25	12.28 EA
646-312FP	51	12"	3/4" MIP × 3/4" full-slip FSWT	✓	25	25	26.58 EA

MIP × Full-Slip Compression Fitting

- Full-slip 7/8" compression fitting
- Full port ball valve available



646-312C



646-312CFP



Item No.	Kit Code	Length	Description	Ball Valve	Min. Qty.	Case Qty.	List Price
646-312C	62	12"	3/4" MIP × 7/8" compression		25	25	19.06 EA
646-312CFP	52	12"	3/4" MIP × 7/8" compression	✓	25	25	35.57 EA

Expansion Tank

- Brass FIP swivel nut includes EPDM gasket
- Soldered saddle branch is 3/4" MIP thread
- Made from Type L copper tube



DO NOT use pipe dope on FIP threads

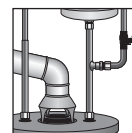

Soldered 3/4" MIP saddle branch connects to any FIP fitting.



Item No.	Kit Code	Length	Connection	Min. Qty.	Case Qty.	List Price
633-3TM11	93	11"	3/4" × 3/4" FIP swivel, with 3/4" MIP branch	25	25	20.32 EA
633-3TM15	91	15"	3/4" × 3/4" FIP swivel, with 3/4" MIP branch	25	25	22.60 EA
633-4TM11	94	11"	1" × 3/4" FIP swivel, with 3/4" MIP branch	25	25	30.98 EA
633-4TM15	92	15"	1" × 3/4" FIP swivel, with 3/4" MIP branch	25	25	33.45 EA

Dielectric Connector

- Zinc-plated casing, inert thermoplastic waterway



Item No.	Kit Code	Length	Connection	Min. Qty.	Case Qty.	List Price
635-32	—	2"	3/4" MIP	25	25	3.91 EA
635-33	23	3"	3/4" MIP	25	25	4.50 EA
635-36	—	6"	3/4" MIP	25	25	6.85 EA
635-43	24	3"	1" MIP	25	25	8.68 EA

Heat Trap Loop

- Retains heat in the water heater to save energy
- Preformed loops save installation time
- Made from Type L copper tube



Item No.	Description	Connection	Min. Qty.	Case Qty.	List Price
636-3TR	270° loop	3/4" MSWT x 3/4" MSWT	25	25	13.28 EA

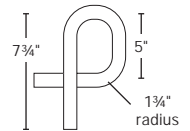

Water Heater Stub Out Loop

- Preformed copper loop bypasses water heater before test
- Made from Type L copper tube

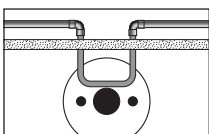
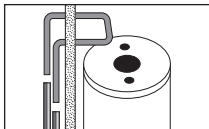

Easily hooks up to the water heater. 8" centers align perfectly with water heater connections.

Item No.	Description	Min. Qty.	Case Qty.	List Price
636-L3888	3/4" male sweat	25	25	15.59 EA
636-3L10888	3/4" male sweat	10	10	35.78 EA
636-4L10888	1" male sweat	10	10	49.95 EA



636-L3888



636-3L10888

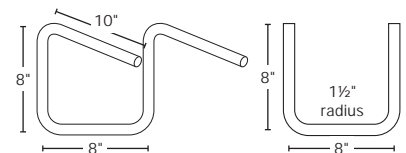

SUPPLY

DRAINAGE

SUPPORT

TESTING

SPECIALTIES

TOOLS

ACCESS

Termination Fitting

FIP × Male Sweat

- Connects easily to MIP supply stops
- Perfect for stubbing up through the floor for closets or lavs
- Square O Strap is crimped to tube
- Made from Type L copper tube
- Lead-free solder joint

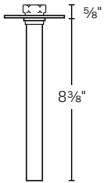

PRESS-FIT
COMPATIBLE

Item No.	CTS	Connection	Min Qty.	Case Qty.	List Price
622-L09CF	1/2"	3/8" FIP × 1/2" MSWT	25	25	9.24 EA

Wal-Let™ Wall Termination Fitting

- One-piece, forged brass fitting with rigid mounting plate
- Secure loose or fragile wall penetrations and reduce the risk of leaks

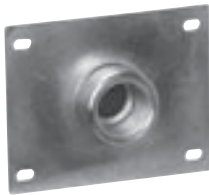

Item No.	Connection	Min Qty.	Case Qty.	List Price
615-214	1/2" MIP × 1/2" FSWT	10	100	9.47 EA
615-234	1/2" MIP × 1/2" FIP	10	100	9.60 EA
615-213	1/2" FIP × 1/2" FSWT	10	100	9.02 EA
615-233	1/2" FIP × 1/2" FIP	10	100	9.64 EA

Water Service Connectors

- 646 series connects to 1" polyethylene water service pipe (ASTM D-2239) with brass IPS-ID insert barb
- 692-1308 has a heavy duty brass nut that includes rubber gasket



646-P4312FD



692-1308

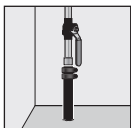

646 series installs with two stainless steel hose clamps per pipe manufacturer's instructions.



Item No.	Connection	Ball Valve	Drain	Length	Min. Qty.	Case Qty.	List Price
POLY WATER SERVICE CONNECTOR							
646-P4312FP	1" IPS-ID barb × 3/4" MIP	✓		12"	25	25	37.57 EA
646-P4312FD	1" IPS-ID barb × 3/4" MIP	✓	✓	12"	25	25	43.38 EA
646-P4412FP	1" IPS-ID barb × 1" MIP	✓		12"	25	25	47.89 EA
646-P4412FD	1" IPS-ID barb × 1" MIP	✓	✓	12"	25	25	54.05 EA
WATER METER EXTENSION NIPPLE							
692-1308	3/4" MIP × swivel water meter thread			8"	25	25	19.23 EA

Replace-A-Valve™ Full-Port Ball Valve

Sweat or Compression Connection

- Full-slip tailpieces for easy installation
- Sweat or compression models
- Full port ball valves

Item No.	Slips Over	Length	Min. Qty.	Case Qty.	List Price
SWEAT					
INDIVIDUALLY BAR-CODED IN A CUT CASE BOX					
600-204V	½" CTS	6¼"	10	10	13.78 EA
600-304V	¾" CTS	7"	10	10	18.90 EA
COMPRESSION					
INDIVIDUALLY BAR-CODED IN A CUT CASE BOX					
600-204CV	½" CTS	9¾"	10	10	22.98 EA
600-304CV	¾" CTS	10½"	10	10	37.85 EA

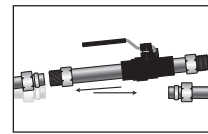

Easy full-slip installation. Perfect for replacing leaking or corroded valves, or valves that have seized up.

Full-Slip Repair Couplings

Sweat or Compression Connection

- Full-slip copper repair couplings
- Safe for repair of cold and hot water lines
- Sweat and compression models



Item No.	Slips Over	Length	Min. Qty.	Case Qty.	List Price
SWEAT					
BULK					
600-203	½" CTS	3"	50	500	1.63 EA
600-206	½" CTS	6"	25	250	2.74 EA
600-212	½" CTS	12"	50	50	4.92 EA
600-303	¾" CTS	3"	25	250	2.26 EA
600-306	¾" CTS	6"	50	50	3.98 EA
600-312	¾" CTS	12"	50	50	7.36 EA
INDIVIDUALLY BAR-CODED IN A CUT CASE BOX					
600-206PK	½" CTS	6"	10	10	2.88 EA
600-212PK	½" CTS	12"	10	10	5.06 EA
600-306PK	¾" CTS	6"	10	10	4.12 EA
600-312PK	¾" CTS	12"	10	10	7.50 EA
COMPRESSION					
BULK					
600-206C	½" CTS	6"	25	25	11.01 EA
600-212C	½" CTS	12"	25	25	13.24 EA
600-306C	¾" CTS	6"	25	25	20.63 EA
600-312C	¾" CTS	12"	25	25	23.50 EA
INDIVIDUALLY BAR-CODED IN A CUT CASE BOX					
600-206CPK	½" CTS	6"	10	10	11.36 EA
600-212CPK	½" CTS	12"	10	10	13.38 EA
600-306CPK	¾" CTS	6"	10	10	20.76 EA
600-312CPK	¾" CTS	12"	10	10	23.64 EA

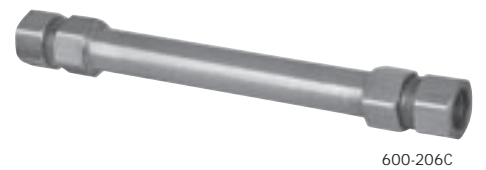



Plated Stub Out Sleeves

Nickel Plated Copper

- Slides over 1/2" or 3/4" CTS stub outs
- 12" long—can be cut to custom lengths

Item No.	Slips Over	Length	Min. Qty.	Case Qty.	List Price
600-212N	1/2" CTS	12"	25	25	10.16 EA
600-312N	3/4" CTS	12"	25	25	12.77 EA



Pre-Cut Copper Nipples

- Made from Type L copper



602-L206



602-L2K

Item No.	Length	CTS	Min. Qty.	Case Qty.	List Price
602-L2015	1 1/2"	1/2"	100	100	0.76 EA
602-L202	2"	1/2"	100	100	0.95 EA
602-L2025	2 1/2"	1/2"	100	100	1.10 EA
602-L203	3"	1/2"	100	100	1.25 EA
602-L2035	3 1/2"	1/2"	100	100	1.51 EA
602-L204	4"	1/2"	100	100	1.56 EA
602-L2045	4 1/2"	1/2"	100	100	1.71 EA
602-L205	5"	1/2"	100	100	1.87 EA
602-L2055	5 1/2"	1/2"	100	100	2.01 EA
602-L206	6"	1/2"	100	100	2.14 EA
602-L2K	100-piece nipple pack: 10 of each nipple listed above		1	1	142.65 KT



Full-Slip Male Adapter

Brass Female Sweat x MIP Thread

- Eliminates tedious measuring
- 3/4" and 1" sizes are ideal for closet or urinal stub out adapters
- Replaces male adapters when hex is not necessary



Tub Spout Application

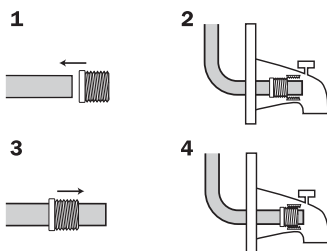

- 1 Slide slip adapter onto copper tube, threads out.
- 2 Push adapter to desired location with tub spout.
- 3 Slide slip adapter 1/4" toward open end.
- 4 Solder adapter in place. Let cool. Install tub spout.

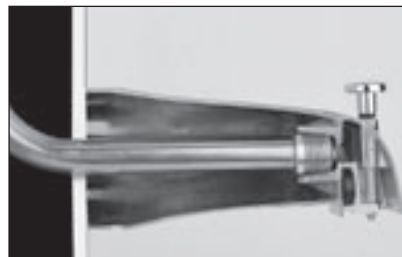

1/2" size is ideal for use with our tub spout ells.

Item No.	Connection	Min. Qty.	Case Qty.	List Price
614-2	1/2" female sweat x 1/2" MIP thread	50	500	1.19 EA
614-3	3/4" female sweat x 3/4" MIP thread	50	500	1.73 EA
614-4	1" female sweat x 1" MIP thread	25	250	2.95 EA

Full-Slip Male Adapter

Brass Compression × MIP Thread

- Full-slip fitting slides completely over ½" CTS
- Use wherever ½" MIP threads must be replaced without soldering
- Use on ½" CTS copper tube only



Tube Spout Application

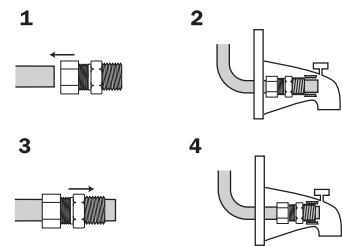

- 1 Slide onto copper tube, threads out.
- 2 Push adapter back with tube spout.
- 3 Slide adapter ¼" toward open end.
- 4 Tighten comp. nut and install tube spout.

Item No.	Connection	Min. Qty.	Case Qty.	List Price
614-22C	5/8" compression × ½" MIP	25	250	3.75 EA



Add-A-Line™ Full-Slip Tee

- ½" or ¾" full-slip sweat trunks
- New one-piece forged brass tee body
- Adding water lines has never been easier



Full-slip sweat tees are an easy way to add new water lines off of existing branches.



Item No.	Trunk Connection	Tee Connection	Min. Qty.	Case Qty.	List Price
INDIVIDUALLY BAR-CODED BAGS IN A CUT CASE BOX					
601-22	½" FSWT	½" MSWT	10	10	5.97 BG
601-32	¾" FSWT	½" MSWT	10	10	7.44 BG





601-20CV



601-22CVM



601-22VX



Add-A-Line™ Full-Slip Valve Tee

- New one-piece forged brass compression and sweat tee body
- 5/8" or 7/8" O.D. compression trunks provide easy and totally torchless installations
- 1/2" or 3/4" full-slip sweat trunks
- Adding water lines has never been easier. Perfect for adding humidifiers, dishwashers, ice makers, or any new water line
- Quality brass ball valve replaces cheap saddle valves that leak and clog
- Attractive, hangable clamshells packaged in a display box

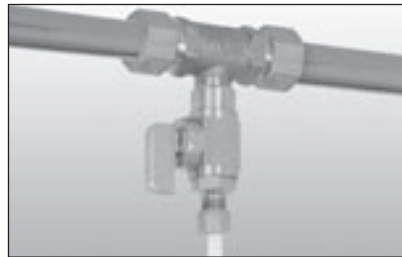

Compression trunks are perfect for adding lines near HVAC or plastic drainage pipe that might get damaged by a soldering torch.

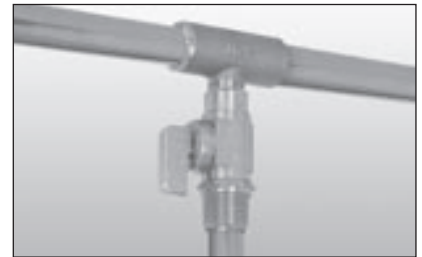

Our FSWT/MIP ball valve model has a versatile connection with both 1/2" MIP threads and 1/2" female sweat in one tee.

Item No.	Trunk Connection	Tee Connection	Min. Qty.	Case Qty.	List Price
COMPRESSION TRUNK					
BAR-CODED CLAMSHELLS IN A CUT CASE BOX					
601-20CV	5/8" O.D. compression	1/4" O.D. compression	6	6	22.46 EA
601-30CV	7/8" O.D. compression	1/4" O.D. compression	6	6	27.95 EA
601-21CV	5/8" O.D. compression	3/8" O.D. compression	6	6	19.83 EA
601-31CV	7/8" O.D. compression	3/8" O.D. compression	6	6	26.63 EA
601-22CVM	5/8" O.D. compression	1/2" FSWT/MIP thread	6	6	20.82 EA
601-32CVM	7/8" O.D. compression	1/2" FSWT/MIP thread	6	6	26.89 EA
601-22CVX	5/8" O.D. compression	1/2" PEX barb	6	6	20.03 EA
601-32CVX	7/8" O.D. compression	1/2" PEX barb	6	6	27.22 EA
SWEAT TRUNK					
BAR-CODED CLAMSHELLS IN A CUT CASE BOX					
601-20V	1/2" female sweat	1/4" O.D. compression	6	6	19.11 EA
601-30V	3/4" female sweat	1/4" O.D. compression	6	6	20.98 EA
601-21V	1/2" female sweat	3/8" O.D. compression	6	6	16.69 EA
601-31V	3/4" female sweat	3/8" O.D. compression	6	6	18.28 EA
601-22VM	1/2" female sweat	1/2" FSWT/MIP thread	6	6	17.84 EA
601-32VM	3/4" female sweat	1/2" FSWT/MIP thread	6	6	19.37 EA
601-22VX	1/2" female sweat	1/2" PEX barb	6	6	16.51 EA
601-32VX	3/4" female sweat	1/2" PEX barb	6	6	18.10 EA



Brass Ball Valve

Female Sweat Connection

- Full port ball valve
- Chrome plated ball, blowout-proof stem
- ANSI/NSF 61-8
- C-377 forged brass

Item No.	Connection	Min. Qty.	Case Qty.	List Price
FULL PORT				
104-22	½" FSWT	10	120	8.75 EA
104-23	¾" FSWT	10	90	14.15 EA
104-24	1" FSWT	6	60	21.50 EA
FULL PORT WITH DRAIN				
105-22	½" FSWT	10	120	13.10 EA
105-23	¾" FSWT	10	60	20.28 EA
105-24	1" FSWT	6	36	29.82 EA



Male Press-Fit Connection

- Chrome plated ball, blowout-proof stem
- Lead-free solder joint
- ANSI/NSF 61-8
- C-377 forged brass

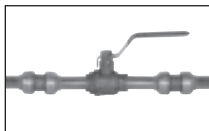

Item No.	Connection	Length	Min. Qty.	Case Qty.	List Price
648-82	½" press-fit	6 ½"	10	10	15.79 EA
648-83	¾" press-fit	7 ¼"	10	10	22.87 EA
648-84	1" press-fit	8 ½"	10	10	39.95 EA



Brass Stop & Waste Valve

Female Sweat Connection

- Brass valve body with stuffing box, neoprene seals
- ANSI/NSF 61-8

Item No.	Connection	Min. Qty.	Case Qty.	List Price
111-22	½" FSWT	10	100	7.42 EA
111-23	¾" FSWT	10	100	7.92 EA



SUPPLY

DRAINAGE

SUPPORT

TESTING

SPECIALTIES

TOOLS

ACCESS

SUPPLY

DRAINAGE

SUPPORT

TESTING

SPECIALTIES

TOOLS

ACCESS

Brass Boiler Drain

MIP × Female Sweat Connection

- Male hose thread spout
- With stuffing box
- ANSI/NSF 61-8
- Neoprene seal

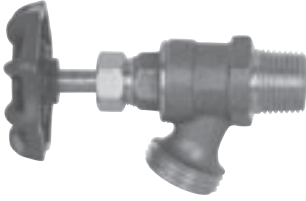

Item No.	Description	Min. Qty.	Case Qty.	List Price
113-32	1/2" MIPs × 1/2" FSWT	10	10	6.89 EA
113-33	3/4" MIPs × 3/4" FSWT	10	100	7.39 EA

Sillcock

1/4-Turn

- Chrome plated brass finish
- 2 1/8" diameter mounting flange



116-32

Standard

- Larger 2 1/8" diameter mounting flange with easy to use pilot holes



117-22

Item No.	Description	Min. Qty.	Case Qty.	List Price
1/4-TURN				
116-22	1/2" FSWT sillcock	10	10	11.82 EA
116-32	1/2" FIP sillcock	5	50	12.22 EA
STANDARD SILLCOCK				
117-22	1/2" FSWT sillcock	10	100	8.25 EA

Frost-Proof* Anti-Siphon Sillcock

Standard Valve

- Longer stem keeps knuckles from scraping on hose threads
- Thicker, easier turning handle
- Nickel plated brass body with black metal handle
- Spout aligning lug
- Female sweat model has 6" of full-slip. Compression connection includes 3" of full-slip



¼-Turn

- Extended tailpiece for ease of installation
- Extra-large mounting flange
- Spout alignment feature
- Nickel plated brass body



Item No.	Length	Connection	Min. Qty.	Case Qty.	List Price
STANDARD					
BULK					
118-204	4"	½" MIP × ½" FSWT	2	40	24.60 EA
118-206	6"	½" MIP × ½" FSWT	2	40	24.75 EA
118-208	8"	½" MIP × ½" FSWT	2	40	26.25 EA
118-210	10"	½" MIP × ½" FSWT	2	40	29.26 EA
118-212	12"	½" MIP × ½" FSWT	2	40	32.40 EA
INDIVIDUALLY BAR-CODED IN A CUT CASE BOX					
118-210PK	10"	½" FSWT, full-slip	5	5	35.10 EA
118-210CPK	10"	¾" O.D. compression	5	5	37.35 EA
¼-TURN					
BULK					
119-204	4"	½" MIP × ½" FSWT	1	25	28.19 EA
119-206	6"	½" MIP × ½" FSWT	1	25	28.38 EA
119-208	8"	½" MIP × ½" FSWT	1	25	30.06 EA
119-210	10"	½" MIP × ½" FSWT	1	25	33.83 EA
119-212	12"	½" MIP × ½" FSWT	1	25	37.13 EA
INDIVIDUALLY BAR-CODED IN A CUT CASE BOX					
119-210PK	10"	½" FSWT, full-slip	5	5	39.38 EA
119-210CPK	10"	¾" O.D. compression	5	5	40.63 EA



* As with all frost-proof hydrants removal of hose is required to insure against freezing and breaking.

SUPPLY

DRAINAGE

SUPPORT

TESTING

SPECIALTIES

TOOLS

ACCESS

Frost-Proof Sillcock Replacement Parts

For 118 Series Only

- Be sure to measure the stem you are replacing to guarantee correct replacement length

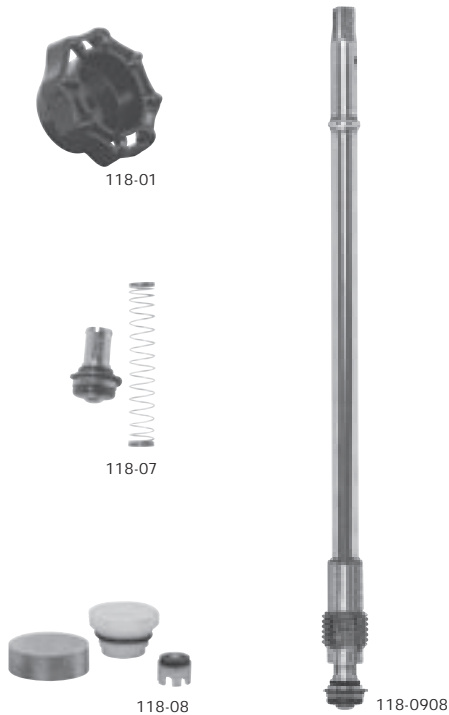

Item No.	Description	Min. Qty.	Case Qty.	List Price
118-01	Sillcock handle, die cast	12	12	1.76 EA
118-02	Handle screw	12	12	0.10 EA
118-03	Face plate and stem packing washers	1	1	0.80 EA
118-04	Stem packing	12	12	0.30 EA
118-05	Neoprene seat washer	12	12	0.10 EA
118-06	Seat washer screw	1	1	0.42 EA
118-07	Stem bottom assembly parts: S.S. spring, o-ring, spring seat, flat gasket, retainer cup, stem packing, seat screw	1	1	2.89 EA
118-08	Vacuum breaker repair kit: cap, plunger, & o-ring	1	1	2.04 EA
118-0904	4" complete stem assembly: includes stem bottom assembly	1	1	7.50 EA
118-0906	6" complete stem assembly: includes stem bottom assembly	1	1	8.00 EA
118-0908	8" complete stem assembly: includes stem bottom assembly	1	1	8.50 EA
118-0910	10" complete stem assembly: includes stem bottom assembly	1	1	9.00 EA
118-0912	12" complete stem assembly: includes stem bottom assembly	1	1	9.50 EA

Vacuum Breaker

¾" Hose Thread Connection

- Solid machined brass



Item No.	Connection	Min. Qty.	Case Qty.	List Price
117-03	¾" female hose thread × ¾" male hose thread	20	240	6.25 EA

Standard Supply Stop

Compression Connection

- Chrome plated brass
- Individually bagged



Item No.	Connection	Min. Qty.	Case Qty.	List Price
INDIVIDUALLY BAR-CODED				
290-20400	⅜" O.D. × ⅜" O.D. compression	1	20	7.08 EA

Sioux Chief Copper Insert Fittings for PEX

- Install Sioux Chief PEX manifolds and fittings per the ASTM F1807 in conjunction with any SDR 9 PEX tubing manufactured to the ASTM F876 or ASTM F877.
- Sioux Chief manifolds and fittings DO NOT void the tube warranty.
- Copper is more malleable and easier to crimp which saves wear and tear on tools and your plumbers.
- Copper's malleability handles stress from the crimp tool, and is far less likely than brass to develop stress fractures.
- Copper is easier to solder than brass.
- Copper is impervious to dezincification.

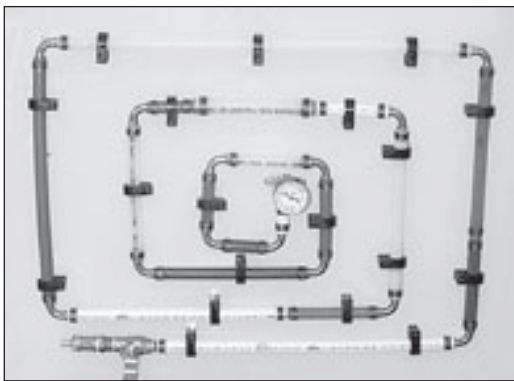

This photo shows Sioux Chief PEX couplings and elbows installed with various brands of SDR-9 PEX tube such as CPI, Vanguard, Wirsbo, and Zurn. Sioux Chief PEX fittings have been independently thermal cycle tested and approved by CSA to be compatible with all manufactured brands of SDR-9 PEX tube.

Important Notes about Sioux Chief PEX Fittings

- All Sioux Chief PEX fittings and rings are manufactured to the ASTM Standard F1807 Specification for Metal Insert Fittings Utilizing a Copper Crimp Ring for SDR 9 Cross-linked Polyethylene (PEX) Tubing. They are interchangeable and compatible with all other fittings and rings manufactured to this same standard.
- Sioux Chief PEX fittings and rings are manufactured to the CSA Standard B137.5 for PEX Tubing Systems for Pressure Applications. At press time, 3/8", 1/2", and 3/4" barbs are certified, and 1" is pending certification.
- All Sioux Chief PEX fittings are guaranteed leakproof for the lifetime of the plumbing system. The use of Sioux Chief PEX fittings and components in conjunction with any other fitting system, component, or brand of tubing manufactured to these referenced standards, will not affect our product warranty for our fittings within the system. The published Sioux Chief warranty will still apply to all Sioux Chief manufactured fittings.



SUPPLY

DRAINAGE

SUPPORT

TESTING

SPECIALTIES

TOOLS

ACCESS



PEX Crimp Ring

- Pure, annealed, black copper rings
- For use with PEX SDR-9 tubing only
- Do not use with PB tube



Related Products
PEX crimp tools

p 289

Item No.	Description	Min. Qty.	Case Qty.	List Price
BULK				
649X1	3/8" PEX	100	1000	0.224 EA
649X2	1/2" PEX	100	1000	0.176 EA
649X3	3/4" PEX	100	500	0.226 EA
649X4	1" PEX	25	250	0.298 EA
BAR-CODED BAGS IN A CUT CASE BOX				
649X1PK2	3/8" PEX, 25/bag	10	10	6.03 BG
649X2PK2	1/2" PEX, 25/bag	10	10	5.25 BG
649X3PK2	3/4" PEX, 25/bag	10	10	6.08 BG
649X4PK2	1" PEX, 10/bag	10	10	3.35 BG

Stub Out Elbow

Standard
Polished Nickel Plated
Square O Strap

- Accepts sweat and compression valves
- Combines easy adapting of copper stub outs with easy installation of PEX system
- Models with Square O Straps affix easily to our Edge bracket or any backing board to provide solid installations



630X246

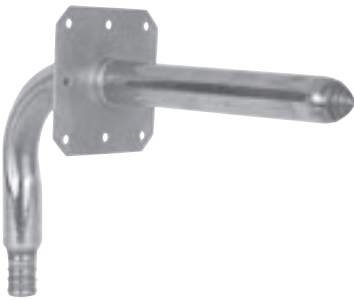

630X246E



Stub out ells combine elbow and cap in one quick and easy stub out fitting.

Item No.	Connection	CTS	Dimensions				Min. Qty.	Case Qty.	List Price
			A	B	C	D			
STANDARD									
BULK									
630X146	3/8" PEX	1/2"	3 1/2"	6"	1 1/4"	—	50	50	3.37 EA
630X148	3/8" PEX	1/2"	3 1/2"	8"	1 1/4"	—	50	50	3.85 EA
630X246	1/2" PEX	1/2"	3 1/2"	6"	1 1/4"	—	50	50	3.19 EA
630X248	1/2" PEX	1/2"	3 1/2"	8"	1 1/4"	—	50	50	3.78 EA
630X2412	1/2" PEX	1/2"	3 1/2"	12"	1 1/4"	—	50	50	5.24 EA
630X2138	1/2" PEX	1/2"	13"	8"	1 1/4"	—	50	50	7.62 EA
630X348	3/4" PEX	3/4"	4"	8"	1 3/4"	—	50	50	7.65 EA
630X3412	3/4" PEX	3/4"	4 1/2"	12"	1 3/4"	—	50	50	12.29 EA
630X3136	3/4" PEX	3/4"	13"	6"	1 3/4"	—	50	50	11.08 EA
INDIVIDUALLY BAR-CODED IN A CUT CASE BOX									
630X246PK	1/2" PEX	1/2"	3 1/2"	6"	1 1/4"	—	20	20	3.33 EA
630X248PK	1/2" PEX	1/2"	3 1/2"	8"	1 1/4"	—	20	20	3.91 EA
POLISHED NICKEL PLATED									
630X248N	1/2" PEX	1/2"	3 1/2"	8"	1 1/4"	—	25	25	8.33 EA
WITH SQUARE O STRAP									
630X148E	3/8" PEX	1/2"	3 1/2"	8"	1 1/4"	1 3/4"	25	25	4.85 EA
630X246E	1/2" PEX	1/2"	3 1/2"	6"	1 1/4"	1 3/4"	25	25	4.13 EA
630W246E	1/2" ProPEX	1/2"	4"	6"	1 1/4"	1 3/4"	25	25	6.39 EA
630X248E	1/2" PEX	1/2"	3 1/2"	8"	1 1/4"	1 3/4"	25	25	4.78 EA
630X348E	3/4" PEX	3/4"	4 1/2"	8"	1 3/4"	2"	25	25	8.65 EA

Guaranteed Leakproof

Spin closed ends have **five** times the wall thickness of the copper tube. Each fitting is factory inspected.

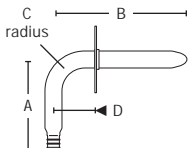

Bullet™ Stub Out Tee-Elbow

- Great for stub outs off ½" PEX runs
- Lead-free solder joint

Item No.	Connection	CTS	Dimensions			Min. Qty.	Case Qty.	List Price
			A	B	C			
638XT263	½" PEX	½"	3"	6"	1¼"	25	25	7.10 EA
638XT283	½" PEX	½"	3"	8"	1¼"	25	25	7.66 EA

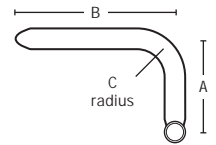

Bullet™ Spin Closed Stub Out Open Ended Stub Out

Item No.	Connection	CTS	Length	Min. Qty.	Case Qty.	List Price
SPIN CLOSED						
BULK						
638X208	½" PEX	½"	8"	100	100	3.06 EA
638X212	½" PEX	½"	12"	100	100	4.13 EA
638X312	¾" PEX	¾"	12"	50	50	8.80 EA
INDIVIDUALLY BAR-CODED IN A CUT CASE BOX						
638X208PK	½" PEX	½"	8"	20	20	3.24 EA
SPIN CLOSED WITH EAR STRAP						
638X212E	½" PEX	½"	12"	50	50	5.27 EA
OPEN						
643X208	½" PEX	½"	8"	100	100	3.06 EA
643X212	½" PEX	½"	12"	100	100	4.14 EA



Stub Air™ Brazen Air Chamber Tee Fitting

- Eliminates on-the-job costs such as: measuring, cutting, cleaning, fluxing, and soldering of up to four joints
- Sturdy brazen saddle joint cannot be damaged during field soldering. Will not fracture due to job site abuse
- Provides stub out and air chamber with PEX connection in one piece
- Spin closed end is guaranteed leakproof

Item No.	Connection	Type	Branch		Air Chamber		Min. Qty.	Case Qty.	List Price
			CTS	Length	CTS	Length			
SPIN CLOSED									
BULK									
682XL5240	½" PEX	L	½"	8"	½"	12"	25	25	12.31 EA
INDIVIDUALLY BAR-CODED IN A CUT CASE BOX									
682XL5240PK	½" PEX	L	½"	8"	½"	12"	10	10	12.58 EA
OPEN									
682XL5213	½" PEX	L	½"	1½"	½"	12"	25	25	10.42 EA
683XM5213	½" PEX	M	½"	1½"	½"	12"	25	25	12.62 EA



683XM5213



682XL5240



Models with open branches work great for tub valve connections, with only ONE solder joint needed.

SUPPLY

DRAINAGE

SUPPORT

TESTING

SPECIALTIES

TOOLS

ACCESS

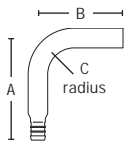

Tub/Shower Pressure Connector

- Perfect for sweat connection to standard tub/shower valves
- MIP and FIP swivel connections means no torch at the tub/shower valve

Item No.	Connection	Dimensions			Min. Qty.	Case Qty.	List Price
		A	B	C			
BULK							
632X143	3/8" PEX x 1/2" male sweat	4"	2 1/4"	1 1/4"	50	50	3.12 EA
632X243	1/2" PEX x 1/2" male sweat	4"	2 1/4"	1 1/4"	50	50	2.48 EA
632X263	1/2" PEX x 1/2" male sweat	6"	2 1/4"	1 1/4"	50	50	3.02 EA
632W273	1/2" ProPEX x 1/2" male sweat	7"	2 1/4"	1 1/4"	50	50	6.32 EA
632W273X	1/2" ProPEX x 1/2" MIP swivel	7"	3"	1 1/4"	50	50	9.78 EA
632X263X	1/2" PEX x 1/2" MIP swivel	6"	3"	1 1/4"	50	50	6.83 EA
632X263Y	1/2" PEX x 1/2" FIP swivel	6"	3"	1 1/4"	50	50	5.57 EA
632X364	3/4" PEX x 3/4" male sweat	6"	4"	1 3/4"	50	50	6.56 EA
632X3412	3/4" PEX x 3/4" male sweat	4"	12"	1 3/4"	50	50	11.10 EA
INDIVIDUALLY BAR-CODED IN A CUT CASE BOX							
632X243PK	1/2" PEX x 1/2" male sweat	4"	2 1/4"	1 1/4"	20	20	2.62 EA



Tub/Shower Elbow

Shower-lock & Drop-ear Models

- Internal 1/2" FIP thread for shower arm or tub nipple
- Shower-lock model includes 2" O.D. locknuts
- Lead-free solder joint



616X2PX



647X2E



647X1E

Item No.	Connection	Min. Qty.	Case Qty.	List Price
SHOWER-LOCK				
BULK				
616X1PX	3/8" PEX x 1/2" FIP	50	50	11.31 EA
616X2PX	1/2" PEX x 1/2" FIP	50	50	10.93 EA
BAR-CODED BAGS IN A CUT CASE BOX				
616X2PXP2	1/2" PEX x 1/2" FIP, 1/bag	20	20	11.08 BG
DROP-EAR				
BULK				
647X1E	3/8" PEX x 1/2" FIP	50	50	5.60 EA
647X2E	1/2" PEX x 1/2" FIP	50	50	4.72 EA
647X23E	3/4" PEX x 1/2" FIP	50	50	6.73 EA
BAR-CODED BAGS IN A CUT CASE BOX				
647X1EPK2	3/8" PEX x 1/2" FIP, 1/bag	20	20	5.76 BG
647X2EPK2	1/2" PEX x 1/2" FIP, 1/bag	20	20	4.99 BG
647X23EPK2	3/4" PEX x 1/2" FIP, 1/bag	20	20	6.90 BG



Water Heater Connector

FIP Elbow Fitting

- Brass FIP swivel nut includes EPDM gasket
- Fitting with 600 WOG full port ball valve available
- Dielectric fitting
- Lead-free solder joint

Item No.	Kit Code	Connection	Dimensions		Ball Valve	Min Qty.	Case Qty.	List Price
			A	B				
631X02	06	3/4" PEX x 3/4" FIP swivel	2 1/2"	4 1/2"		25	25	6.11 EA
631X06	07	3/4" PEX x 3/4" FIP swivel	6"	6"		25	25	8.74 EA
631X02FP	01	3/4" PEX x 3/4" FIP swivel	2 1/2"	6"	✓	12	12	22.48 EA

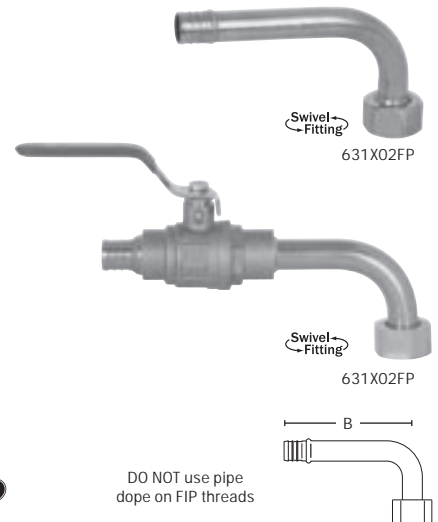

FIP Straight Fitting

- Full-flow, dielectric fitting—no flow restriction
- Brass FIP swivel nut includes gasket
- Fitting with 600 WOG full port ball valve available
- 3/4" FIP branch for 2 gallon expansion tank
- Lead-free solder joint

Item No.	Kit Code	Connection	Length	Ball Valve	Min. Qty.	Case Qty.	List Price
BULK							
633X02	31	3/4" PEX x 3/4" FIP swivel	2"		25	25	4.85 EA
633X18	32	3/4" PEX x 3/4" FIP swivel	18"		25	25	13.90 EA
633X418	36	3/4" PEX x 1" FIP swivel	18"		25	25	21.10 EA
633X18FP	21	3/4" PEX x 3/4" FIP swivel	18"	✓	25	25	28.26 EA
633X418FP	71	3/4" PEX x 1" FIP swivel	18"	✓	25	25	35.08 EA
633X18FPT	25	3/4" PEX x 3/4" FIP swivel, with 3/4" FIP branch	18"	✓	20	20	41.31 EA
633X18FRV	22	3/4" PEX x 3/4" FIP swivel, with pressure release 3/8" O.D. compression	18"	✓	10	10	68.52 EA
INDIVIDUALLY BAR-CODED IN A CUT CASE BOX							
633X02PK	—	3/4" PEX x 3/4" FIP swivel	2"		25	25	5.00 EA
633X18PK	—	3/4" PEX x 3/4" FIP swivel	18"		25	25	14.12 EA

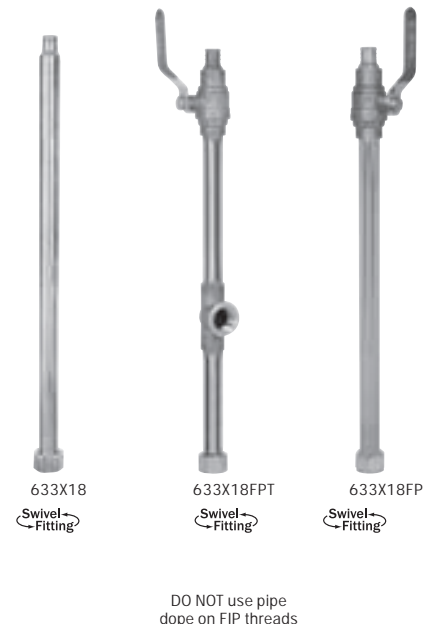

Flexible FIP Fitting

- Brass FIP swivel nut includes EPDM gasket
- Fitting with 600 WOG full port ball valve available
- Flexible dielectric fitting works well in tight spaces
- Lead-free solder joint

Item No.	Kit Code	Connection	Length	Ball Valve	Min. Qty.	Case Qty.	List Price
634X418	46	3/4" PEX x 3/4" FIP swivel	18"		25	25	14.40 EA
634X418FP	41	3/4" PEX x 3/4" FIP swivel	18"	✓	25	25	27.82 EA

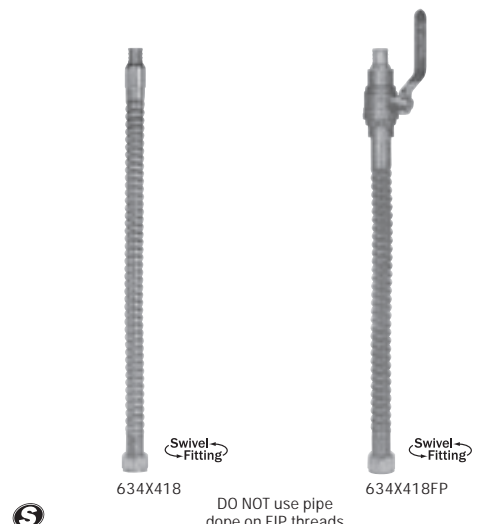

SUPPLY

DRAINAGE

SUPPORT

TESTING

SPECIALTIES

TOOLS

ACCESS

SUPPLY

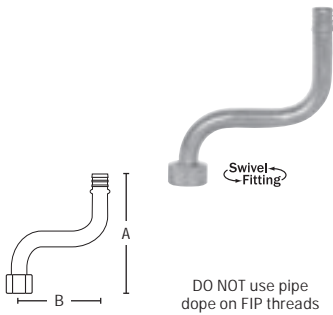

DRAINAGE

SUPPORT

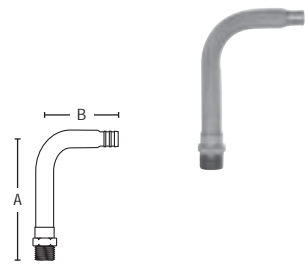

TESTING

SPECIALTIES

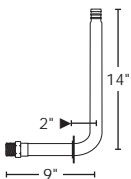

TOOLS

ACCESS



Water Heater Connector

FIP S-bend

- Brass FIP swivel nut includes EPDM gasket
- Great for routing PEX away from water heater stack
- Dielectric fitting

Item No.	Kit Code	Connection	Dimensions		Min. Qty.	Case Qty.	List Price
			A	B			
631XS	09	3/4" PEX x 3/4" FIP swivel	6"	4 1/2"	50	50	7.80 EA

MIP Elbow

- Full flow fitting—no flow restriction
- Lead-free solder joint

Item No.	Kit Code	Connection	Dimensions		Min. Qty.	Case Qty.	List Price
			A	B			
631XM	08	3/4" PEX x 3/4" MIP	6"	4"	25	25	9.82 EA

MIP Elbow with Square O Strap

- Full flow fitting—no flow restriction
- Lead-free solder joint
- 631WM0914RFE specifically designed for applications when supply is coming from above

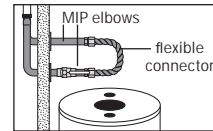

Test with flexible FIP x FIP connector before attaching to water heater.

Item No.	Kit Code	Connection	Ball Valve	Min. Qty.	Case Qty.	List Price
631WM0914E	-	3/4" ProPEX x 3/4" MIP		10	10	25.75 EA
631WM0914FPE	-	3/4" ProPEX x 3/4" MIP	✓	10	10	39.92 EA
631WM0914RFE	-	3/4" ProPEX x 3/4" MIP	✓	10	10	39.92 EA
631XM0914E	-	3/4" PEX x 3/4" MIP		10	10	20.79 EA
631XM0914FPE	-	3/4" PEX x 3/4" MIP	✓	10	10	34.61 EA

MIP Straight

- Full flow fitting—no flow restriction
- Fitting with 600 WOG full port ball valve available
- Lead-free solder joint

Item No.	Kit Code	Connection	Ball Valve	Length	Min. Qty.	Case Qty.	List Price
646X318	62	3/4" PEX x 3/4" MIP		18"	25	25	15.04 EA
646X318FP	51	3/4" PEX x 3/4" MIP	✓	18"	25	25	28.51 EA

Water Heater Stub Out Loop

- Preformed copper loop bypasses water heater before test
- Made from Type L copper tube

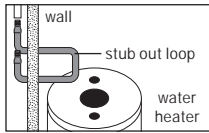

Easily hooks up to the water heater. 8" centers align perfectly with water heater connections.

Item No.	Connection	Min. Qty.	Case Qty.	List Price
636X38883	3/4" PEX	12	12	34.48 EA
636X48884	1" PEX	12	12	42.43 EA

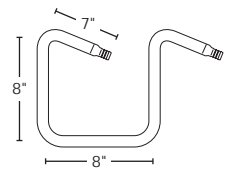

Valved Service Loop

- Fitting with 600 WOG full port ball valve
- Lead-free solder joint

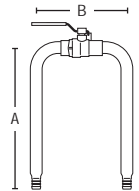

Item No.	Connection	Ball Valve	Dimensions		Min. Qty.	Case Qty.	List Price
			A	B			
636X3FPL	3/4" PEX x 3/4" PEX	✓	15"	7"	12	12	40.00 EA



Coupling



Item No.	Description	Min. Qty.	Case Qty.	List Price
BULK				
645X1	3/8" PEX x 3/8" PEX	100	1000	0.86 EA
645X2	1/2" PEX x 1/2" PEX	100	1000	0.65 EA
645X32	1/2" PEX x 3/4" PEX	50	500	1.60 EA
645X3	3/4" PEX x 3/4" PEX	50	500	0.80 EA
645X43	3/4" PEX x 1" PEX	25	250	2.44 EA
645X4	1" PEX x 1" PEX	25	250	2.04 EA
BAR-CODED BAGS IN A CUT CASE BOX				
645X1PK2	3/8" PEX x 3/8" PEX, 2/bag	20	20	2.07 BG
645X12PK2	3/8" PEX x 1/2" PEX, 2/bag	20	20	4.06 BG
645X2PK2	1/2" PEX x 1/2" PEX, 2/bag	20	20	1.63 BG
645X32PK2	1/2" PEX x 3/4" PEX, 2/bag	20	20	3.55 BG
645X3PK2	3/4" PEX x 3/4" PEX, 2/bag	10	10	1.95 BG
645X43PK2	3/4" PEX x 1" PEX, 2/bag	10	10	5.24 BG
645X4PK2	1" PEX x 1" PEX, 2/bag	10	10	4.44 BG



SUPPLY

DRAINAGE

SUPPORT

TESTING

SPECIALTIES

TOOLS

ACCESS



Tee

- Full-flow—no restriction
- One piece solid brass

Item No.	Description (Branch × Branch × Tee)	Min. Qty.	Case Qty.	List Price
BULK				
641X111	3/8" PEX × 3/8" PEX × 3/8" PEX	50	500	3.60 EA
641X222	1/2" PEX × 1/2" PEX × 1/2" PEX	50	500	2.11 EA
641X223	1/2" PEX × 1/2" PEX × 3/4" PEX	20	200	3.65 EA
641X322	3/4" PEX × 1/2" PEX × 1/2" PEX	20	200	3.25 EA
641X323	3/4" PEX × 1/2" PEX × 3/4" PEX	20	200	3.25 EA
641X332	3/4" PEX × 3/4" PEX × 1/2" PEX	20	200	3.25 EA
641X333	3/4" PEX × 3/4" PEX × 3/4" PEX	20	200	3.23 EA
641X334	3/4" PEX × 3/4" PEX × 1" PEX	20	200	8.32 EA
641X432	1" PEX × 3/4" PEX × 1/2" PEX	20	200	11.21 EA
641X433	1" PEX × 3/4" PEX × 3/4" PEX	20	200	8.42 EA
641X434	1" PEX × 3/4" PEX × 1" PEX	20	20	8.42 EA
641X442	1" PEX × 1" PEX × 1/2" PEX	20	200	8.23 EA
641X443	1" PEX × 1" PEX × 3/4" PEX	20	200	8.23 EA
641X444	1" PEX × 1" PEX × 1" PEX	20	200	8.23 EA
BAR-CODED BAGS IN A CUT CASE BOX				
641X111PK2	3/8" PEX × 3/8" PEX × 3/8" PEX, 1/bg	20	20	3.79 BG
641X222PK2	1/2" PEX × 1/2" PEX × 1/2" PEX, 1/bg	20	20	2.40 BG
641X223PK2	1/2" PEX × 1/2" PEX × 3/4" PEX, 1/bg	20	20	3.84 BG
641X322PK2	3/4" PEX × 1/2" PEX × 1/2" PEX, 1/bg	20	20	3.42 BG
641X323PK2	3/4" PEX × 1/2" PEX × 3/4" PEX, 1/bg	20	20	3.42 BG
641X332PK2	3/4" PEX × 3/4" PEX × 1/2" PEX, 1/bg	20	20	3.42 BG
641X333PK2	3/4" PEX × 3/4" PEX × 3/4" PEX, 1/bg	20	20	3.40 BG
641X443PK2	1" PEX × 1" PEX × 3/4" PEX, 1/bg	20	20	8.40 BG
641X444PK2	1" PEX × 1" PEX × 1" PEX, 1/bg	20	20	8.40 BG

Elbow

- Tube stops formed into each fitting
- One piece copper



Item No.	Description	Min. Qty.	Case Qty.	List Price
BULK				
642X1	3/8" PEX × 3/8" PEX	25	250	1.49 EA
642X2	1/2" PEX × 1/2" PEX	25	250	1.15 EA
642X3	3/4" PEX × 3/4" PEX	25	250	1.56 EA
642X4	1" PEX × 1" PEX	25	25	4.81 EA
BAR-CODED BAGS IN A CUT CASE BOX				
642X1PK2	3/8" PEX × 3/8" PEX, 2/bag	20	20	3.34 BG
642X2PK2	1/2" PEX × 1/2" PEX, 2/bag	20	20	2.64 BG
642X23PK2	1/2" PEX × 3/4" PEX, 2/bag	20	20	8.62 BG
642X3PK2	3/4" PEX × 3/4" PEX, 2/bag	20	20	3.49 BG
642X4PK2	1" PEX × 1" PEX, 2/bag	20	20	9.92 BG



Test Plug

- Poly plugs for temporary use only

Item No.	Description	Min. Qty.	Case Qty.	List Price
BRASS				
BULK				
640X01	3/8" PEX	100	1000	0.99 EA
640X02	1/2" PEX	100	1000	0.94 EA
640X03	3/4" PEX	100	1000	1.51 EA
640X04	1" PEX	25	250	2.41 EA
BAR-CODED BAGS IN A CUT CASE BOX				
640X01PK2	3/8" PEX, 2/bag	20	20	2.34 BG
640X02PK2	1/2" PEX, 2/bag	20	20	2.24 BG
640X03PK2	3/4" PEX, 2/bag	20	20	3.35 BG
640X04PK2	1" PEX, 2/bag	20	20	5.18 BG
POLY				
640X12	1/2" PEX	100	1000	0.58 EA
640X13	3/4" PEX	100	1000	0.59 EA



640X01



640X12

Straight Adapter

Male Sweat × PEX
Female Sweat × PEX

Item No.	Description	Min. Qty.	Case Qty.	List Price
MALE SWEAT				
BULK				
643X11	3/8" PEX × 3/8" MSWT	100	1000	1.30 EA
643X1	3/8" PEX × 1/2" MSWT	100	1000	1.30 EA
643X2	1/2" PEX × 1/2" MSWT	100	1000	0.65 EA
643X202	1/2" PEX × 1/2" MSWT, 2" long	50	500	1.40 EA
643X32	1/2" PEX × 3/4" MSWT	50	500	1.74 EA
643X23	3/4" PEX × 1/2" MSWT	50	100	1.41 EA
643X3	3/4" PEX × 3/4" MSWT	50	500	1.20 EA
643X43	3/4" PEX × 1" MSWT	25	250	2.65 EA
643X34	1" PEX × 3/4" MSWT	25	250	2.67 EA
643X4	1" PEX × 1" MSWT	25	250	3.09 EA
BAR-CODED BAGS IN A CUT CASE BOX				
643X1PK2	3/8" PEX × 1/2" MSWT, 2/bag	20	20	2.97 BG
643X2PK2	1/2" PEX × 1/2" MSWT, 2/bag	20	20	1.64 BG
643X32PK2	1/2" PEX × 3/4" MSWT, 2/bag	10	10	3.96 BG
643X23PK2	3/4" PEX × 1/2" MSWT, 2/bag	20	20	3.16 BG
643X3PK2	3/4" PEX × 3/4" MSWT, 2/bag	10	10	2.89 BG
FEMALE SWEAT				
BULK				
644X1	3/8" PEX × 1/2" FSWT	100	1000	1.31 EA
644X2	1/2" PEX × 1/2" FSWT	100	1000	0.73 EA
644X32	1/2" PEX × 3/4" FSWT	50	500	2.22 EA
644X3	3/4" PEX × 3/4" FSWT	50	500	1.18 EA
644X43	3/4" PEX × 1" FSWT	25	250	3.07 EA
644X34	1" PEX × 3/4" FSWT	25	250	2.81 EA
644X4	1" PEX × 1" FSWT	25	250	3.37 EA
BAR-CODED BAGS IN A CUT CASE BOX				
644X1PK2	3/8" PEX × 1/2" FSWT, 2/bag	20	20	2.98 BG
644X2PK2	1/2" PEX × 1/2" FSWT, 2/bag	20	20	1.81 BG
644X32PK2	1/2" PEX × 3/4" FSWT, 2/bag	10	10	4.81 BG
644X3PK2	3/4" PEX × 3/4" FSWT, 2/bag	10	10	2.73 BG
644X4PK2	1" PEX × 1" FSWT, 2/bag	5	5	7.80 EA



Straight Adapter

MIP × PEX

FIP × PEX

Compression × PEX

- Connects PEX to 3/8" O.D. tube
- For PEX to dishwasher hook-ups or lav/sink supplies
- Lead-free solder joint



646X32



647X3



637X711

Item No.	Description	Material	Min. Qty.	Case Qty.	List Price
MIP					
BULK					
646X2	1/2" PEX × 1/2" MIP	brass	100	100	2.62 EA
646X32	1/2" PEX × 3/4" MIP	copper/brass	50	50	4.40 EA
646X3	3/4" PEX × 3/4" MIP	brass	25	250	3.81 EA
646X34	1" PEX × 3/4" MIP	copper	25	25	5.11 EA
646X4	1" PEX × 1" MIP	brass	50	50	9.34 EA
BAR-CODED BAGS IN A CUT CASE BOX					
646X12PK2	3/8" PEX × 1/2" MIP, 1/bag	brass	20	20	4.35 BG
646X2PK2	1/2" PEX × 1/2" MIP, 1/bag	brass	20	20	2.83 BG
646X23PK2	3/4" PEX × 1/2" MIP, 1/bag	brass	20	20	4.28 BG
646X32PK2	1/2" PEX × 3/4" MIP, 1/bag	copper/brass	20	20	5.05 BG
646X3PK2	3/4" PEX × 3/4" MIP, 1/bag	brass	20	20	4.00 BG
646X43PK2	3/4" PEX × 1" MIP, 1/bag	copper/brass	20	20	7.28 BG
646X4PK2	1" PEX × 1" MIP, 1/bag	brass	20	20	9.77 BG
FIP					
BULK					
647X2	1/2" PEX × 1/2" FIP	brass	50	250	3.85 EA
647X3	3/4" PEX × 3/4" FIP	brass	50	50	4.76 EA
647X4	1" PEX × 1" FIP	copper/brass	50	50	10.30 EA
BAR-CODED BAGS IN A CUT CASE BOX					
647X2PK2	1/2" PEX × 1/2" FIP, 1/bag	brass	10	10	4.03 BG
647X23PK2	1/2" PEX × 3/4" FIP, 1/bag	brass	10	10	5.78 BG
647X3PK2	3/4" PEX × 3/4" FIP, 1/bag	brass	10	10	4.94 BG
647X4PK2	1" PEX × 1" FIP, 1/bag	copper/brass	10	10	10.80 BG
COMPRESSION					
637X711	3/8" PEX × 3/8" O.D. compression	copper/brass	50	50	6.63 EA
637X721	1/2" PEX × 3/8" O.D. compression	copper/brass	50	50	6.54 EA



Straight Adapter

CPVC × PEX

- A quick and easy transition
- Perfect for hooking up PEX underground water service lines to CPVC in-house piping systems

PB × PEX

- Great for adapting PB lines to new PEX lines
- Each adapter is bagged with one natural copper PB crimp ring and one black copper PEX crimp ring

Item No.	Description	Min. Qty.	Case Qty.	List Price
CPVC				
BULK				
645XC2	½" CPVC × ½" PEX	50	50	4.32 EA
645XC3	¾" CPVC × ¾" PEX	50	50	5.07 EA
645XC4	1" CPVC × 1" PEX	20	20	11.97 EA
645WC2	½" CPVC × ½" ProPEX	50	50	5.72 EA
645WC3	¾" CPVC × ¾" ProPEX	50	50	7.84 EA
645WC4	1" CPVC × 1" ProPEX	20	20	14.52 EA
BAR-CODED BAGS IN A CUT CASE BOX				
645XC2PK2	½" CPVC × ½" PEX, 1/bag	10	10	4.52 BG
645XC3PK2	¾" CPVC × ¾" PEX, 1/bag	10	10	5.33 BG
PB				
BULK				
645X2G	½" PEX × ½" PB	50	50	1.63 EA
645X3G	¾" PEX × ¾" PB	50	50	2.09 EA
BAR-CODED BAGS IN A CUT CASE BOX				
645X2GPK2	½" PEX × ½" PB, 1/bag	10	10	1.81 BG
645X3GPK2	¾" PEX × ¾" PB, 1/bag	10	10	2.27 BG



Elbow Adapter

Male Sweat × PEX

Female Sweat × PEX

- Great multipurpose sweat × PEX elbow
- Perfect for sweat connection to standard tub/shower valves

Item No.	Description	Dimensions			Min. Qty.	Case Qty.	List Price
		A	B	C			
MALE SWEAT							
BULK							
632X122	¾" PEX × ½" MSWT	1 5/8"	1 ½"	5/8"	100	1000	2.40 EA
632X222	½" PEX × ½" MSWT	1 5/8"	1 ½"	5/8"	100	1000	2.15 EA
632X232	½" PEX × ¾" MSWT	2 ½"	1 ¾"	5/8"	50	50	3.18 EA
632X332	¾" PEX × ¾" MSWT	2"	1 3/8"	1 1/16"	25	250	2.89 EA
BAR-CODED BAGS IN A CUT CASE BOX							
632X222PK2	½" PEX × ½" MSWT	1 5/8"	1 ½"	5/8"	20	20	4.47 EA
FEMALE SWEAT							
BULK							
632X125	¾" PEX × ½" FSWT	1 5/8"	1 ½"	5/8"	100	1000	2.40 EA
632X225	½" PEX × ½" FSWT	1 5/8"	1 ½"	5/8"	100	1000	2.15 EA
632X335	¾" PEX × ¾" FSWT	2"	1 3/8"	1 1/16"	25	250	3.09 EA
BAR-CODED BAGS IN A CUT CASE BOX							
632X125PK2	¾" PEX × ½" FSWT	1 5/8"	1 ½"	5/8"	20	20	4.97 EA
632X225PK2	½" PEX × ½" FSWT	1 5/8"	1 ½"	5/8"	20	20	4.47 EA
632X335PK2	¾" PEX × ¾" FSWT	2"	1 3/8"	1 1/16"	20	20	6.35 EA



645XC2



645WC3



645X2G

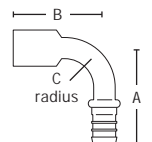

SUPPLY

DRAINAGE

SUPPORT

TESTING

SPECIALTIES

TOOLS

ACCESS

SUPPLY

DRAINAGE

SUPPORT

TESTING

SPECIALTIES

TOOLS

ACCESS

Elbow Adapter

MIP × PEX

- Full flow
- Lead-free solder joint
- 3/8" MIP is great for dishwasher installations



632X222M

FIP × PEX

- Full-flow
- Brass FIP swivel nut includes gasket

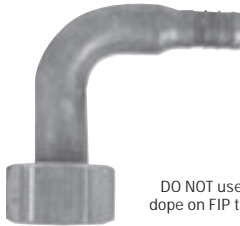

Swivel-Fitting

DO NOT use pipe dope on FIP threads

637X235



637X217

Compression × PEX

- Connects PEX to 3/8" O.D. tube
- For PEX to ice maker hook-ups or lav/sink supplies
- Lead-free solder joint

Item No.	Description	Material	Min. Qty.	Case Qty.	List Price
MIP					
BULK					
632X121M	3/8" PEX × 3/8" MIP	brass	50	50	5.32 EA
632X221M	1/2" PEX × 3/8" MIP	brass	50	50	5.08 EA
632X222M	1/2" PEX × 1/2" MIP	copper/brass	50	50	5.25 EA
632X332M	3/4" PEX × 3/4" MIP	copper/brass	50	50	6.36 EA
BAR-CODED BAGS IN A CUT CASE BOX					
632X221MPK2	1/2" PEX × 3/8" MIP, 1/bag	brass	10	10	5.15 BG
632X222MPK2	1/2" PEX × 1/2" MIP, 1/bag	copper/brass	10	10	5.45 BG
632X232MPK2	1/2" PEX × 3/4" MIP, 1/bag	copper/brass	10	10	7.92 BG
FIP					
BULK					
637X235	1/2" PEX × 3/4" FIP swivel	copper/brass	50	50	5.01 EA
637X335	3/4" PEX × 3/4" FIP swivel	copper/brass	25	25	4.78 EA
BAR-CODED BAGS IN A CUT CASE BOX					
637X335PK2	3/4" PEX × 3/4" FIP swivel	copper/brass	10	10	4.72 EA
COMPRESSION					
632X117	3/8" PEX × 3/8" O.D. compression	copper/brass	50	50	7.17 EA
632X217	1/2" PEX × 3/8" O.D. compression	copper/brass	50	50	6.55 EA



Tee Adapter

PB × PB × PEX

- Lead-free solder joint
- Two piece copper



Item No.	Dimensions (Branch × Branch × Tee)	Min. Qty.	Case Qty.	List Price
BULK				
641-222X	1/2" PB × 1/2" PB × 1/2" PEX	50	50	4.60 EA
641-332X	3/4" PB × 3/4" PB × 1/2" PEX	50	50	5.49 EA
641-333X	3/4" PB × 3/4" PB × 3/4" PEX	50	50	6.52 EA
BAR-CODED BAGS IN A CUT CASE BOX, 1/BAG				
641-222XPK2	1/2" PB × 1/2" PB × 1/2" PEX	10	10	4.78 BG
641-333XPK2	3/4" PB × 3/4" PB × 3/4" PEX	10	10	6.70 BG

Ballcock Adapter

Straight and Elbow

- Easily connects PEX to ballcock thread
- Swivel ballcock nut includes Buna N nose cone
- Long radius elbow fitting for smoother flow

Item No.	Description	Dimensions		Min. Qty.	Case Qty.	List Price
		A	B			
STRAIGHT						
637X410	3/8" PEX x swivel ballcock	1 5/8"	—	50	500	2.10 EA
637X420	1/2" PEX x swivel ballcock	1 1/2"	—	50	50	2.01 EA
ELBOW						
637X413	3/8" PEX x swivel ballcock	2 1/4"	2 5/8"	50	50	3.48 EA
637X423	1/2" PEX x swivel ballcock	2 1/4"	2 5/8"	50	50	3.37 EA

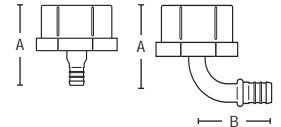

Faucet Adapter

Straight and Elbow Fittings

- Easily connects PEX to faucet thread
- High impact FIP swivel nut includes Buna N nose cone
- Copper component only available

Item No.	Description	Dimensions		Min. Qty.	Case Qty.	List Price
		A	B			
STRAIGHT						
BULK						
637X10	3/8" PEX x 1/2" FIP swivel	1 5/16"	—	50	50	1.41 EA
637X20	1/2" PEX x 1/2" FIP swivel	1 3/16"	—	50	500	1.09 EA
637X20C	1/2" PEX x copper component only	1 1/16"	—	50	500	0.90 EA
BAR-CODED BAGS IN A CUT CASE BOX						
637X10PK2	3/8" PEX x 1/2" FIP swivel, 2/bag	1 5/16"	—	10	10	3.22 BG
637X20PK2	1/2" PEX x 1/2" FIP swivel, 2/bag	1 3/16"	—	10	10	2.58 BG
ELBOW						
637X15	3/8" PEX x 1/2" FIP swivel	1 1/2"	1 1/2"	50	500	2.36 EA
637X25	1/2" PEX x 1/2" FIP swivel	1 1/2"	1 1/2"	50	500	2.16 EA

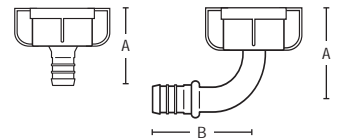

Dishwasher Elbow

- Eliminates crimping behind/under dishwasher
- Two-piece swivel connection allows for separate hook-up of dishwasher and tubing
- Final swivel connection is easy after elbow is connected to the dishwasher

Item No.	Connection	Min. Qty.	Case Qty.	List Price
ADAPTER AND ELBOW				
632WR11	3/8" MIP elbow x 3/8" ProPEX swivel	5	50	9.88 EA
632XR11	3/8" MIP elbow x 3/8" PEX swivel	5	50	9.43 EA
632WR21	3/8" MIP elbow x 1/2" ProPEX swivel	5	50	9.46 EA
632XR21	3/8" MIP elbow x 1/2" PEX swivel	5	50	8.96 EA
ADAPTER ONLY				
637WR11	3/8" O.D. female compression x 3/8" ProPEX	5	50	8.43 EA
637XR11	3/8" O.D. female compression x 3/8" PEX	5	50	7.77 EA
637WR21	3/8" O.D. female compression x 1/2" ProPEX	5	50	7.90 EA
637XR21	3/8" O.D. female compression x 1/2" PEX	5	50	7.30 EA

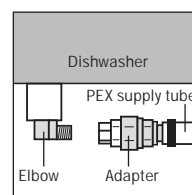

SUPPLY

DRAINAGE

SUPPORT

TESTING

SPECIALTIES

TOOLS

ACCESS



Brass Ball Valve

- Chrome plated ball, blowout-proof stem
- ANSI/NSF 61-8
- C-377 forged brass

Item No.	Connection	Min. Qty.	Case Qty.	List Price
STANDARD PORT				
648X2	1/2" PEX	10	100	10.15 EA
648X3	3/4" PEX	10	100	14.94 EA
FULL PORT				
648X4FP	1" PEX	10	10	29.35 EA



Brass Stop & Waste Valve

- Brass valve body with stuffing box, neoprene seals
- Lead-free solder joint
- ANSI/NSF 61-8



Item No.	Connection	Min. Qty.	Case Qty.	List Price
648X2W	1/2" PEX	12	12	11.80 EA
648X3W	3/4" PEX	12	12	15.10 EA

1/4-Turn Sillcock

1/4-Turn Ball Valve

- Chrome plated brass finish
- 2-1/8" diameter mounting flange



Item No.	Connection	Min. Qty.	Case Qty.	List Price
116X22	1/2" PEX	25	25	14.45 EA

Frost-Proof* Anti-Siphon Sillcock

Standard

- Longer stem keeps knuckles from scraping on hose threads
- Thicker, easier turning handle
- Nickel plated brass body with black metal handle

¼-Turn

- Extended tailpiece for ease of installation
- Extra-large mounting flange
- Spout alignment feature
- Nickel plated brass body

Item No.	Connection	Length	Min. Qty.	Case Qty.	List Price
STANDARD					
118X204P	½" PEX	4"	2	2	28.20 EA
118X206P	½" PEX	6"	2	40	28.44 EA
118X208P	½" PEX	8"	2	40	30.12 EA
118X210P	½" PEX	10"	2	40	30.33 EA
118X212P	½" PEX	12"	2	40	37.32 EA
¼-TURN					
119X204P	½" PEX	4"	2	2	32.38 EA
119X206P	½" PEX	6"	2	2	32.63 EA
119X208P	½" PEX	8"	1	25	34.56 EA
119X210P	½" PEX	10"	1	25	39.69 EA
119X212P	½" PEX	12"	1	25	42.70 EA

* As with all frost-proof hydrants removal of hose is required to ensure against freezing and breaking.



118X208P



119X210P

Ice Maker Valve

Straight and Tee

- Great for adding ¼" O.D. supply lines for ice makers or humidifiers
- Lead-free solder joint

Item No.	Connection	Min. Qty.	Case Qty.	List Price
STRAIGHT				
BULK				
637X920	½" PEX × ¼" O.D. compression	25	250	10.24 EA
BAR-CODED BAGS IN A CUT CASE BOX				
637X920PK2	½" PEX × ¼" O.D. compression	10	10	10.41 EA
TEE				
637X9220	½" PEX × ¼" O.D. compression	25	250	11.15 EA



637X920



637X922



Standard Supply Stop

Angle and Straight

- Delrin and brass ferrule included
- Chrome plated brass

Item No.	Connection	Min. Qty.	Case Qty.	List Price
ANGLE				
648X2FA	½" PEX × ⅜" O.D. compression	5	60	5.12 EA
STRAIGHT				
648X2FS	½" PEX × ⅜" O.D. compression	5	60	5.42 EA



648X2FA



648X2FS

SUPPLY

DRAINAGE

SUPPORT

TESTING

SPECIALTIES

TOOLS

ACCESS

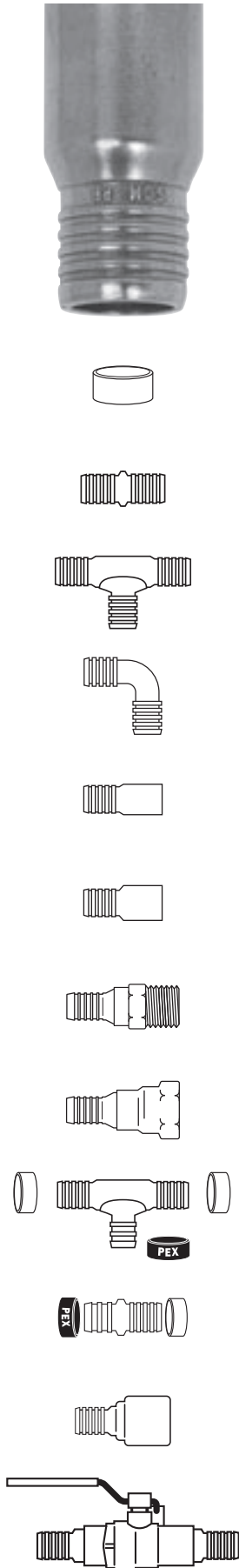

Important Notes about Fittings for Polybutylene Tube

- Although Polybutylene (PB) tube is no longer installed in the United States, demand for barbed insert fittings for PB systems continues to be high, especially in Canada. For your convenience, we will continue to offer the most popular PB fittings as long as demand remains significant. (See stock PB fittings below.)
- Sioux Chief will no longer accept returns on PB barbed fittings.
- All sales are final.
- All Sioux Chief PB fittings conform to CSA B137.8 and ASTM F-1380 Standard for Metal Insert Barb Fittings for Polybutylene, and are designed for use with Polybutylene SDR 11 Tube conforming to ASTM D-3309.

Item No.	Description	Min. Qty.	Case Qty.	List Price
CRIMP RINGS FOR PB				
649-1	3/8" PB crimp ring	100	1000	0.241 EA
649-2	1/2" PB crimp ring	100	1000	0.256 EA
649-3	3/4" PB crimp ring	100	500	0.311 EA
649-4	1" PB crimp ring	25	250	0.416 EA
PB COUPLING				
645-2	1/2" PB x 1/2" PB	100	1000	1.15 EA
645-3	3/4" PB x 3/4" PB	50	500	1.50 EA
TEE				
641-222	1/2" PB x 1/2" PB x 1/2" PB	50	500	3.24 EA
641-332	3/4" PB x 3/4" PB x 1/2" PB	20	200	4.26 EA
641-333	3/4" PB x 3/4" PB x 3/4" PB	20	200	4.50 EA
ELBOW				
642-2	1/2" x 1/2" PB	25	250	2.07 EA
642-3	3/4" x 3/4" PB	25	250	2.69 EA
PB x MALE SWEAT ADAPTER				
643-2	1/2" PB x 1/2" MSWT	100	1000	1.21 EA
643-3	3/4" PB x 3/4" MSWT	50	500	2.29 EA
643-3B	3/4" PB blue x 3/4" MSWT	50	50	2.43 EA
PB x FEMALE SWEAT ADAPTER				
644-2	1/2" PB x 1/2" FSWT	100	1000	1.27 EA
644-3	3/4" PB x 3/4" FSWT	50	500	2.04 EA
PB x MALE THREAD ADAPTER				
646-2	1/2" PB x 1/2" MIP	100	100	5.41 EA
646-3	3/4" PB x 3/4" MIP	25	25	7.15 EA
PB x FEMALE THREAD ADAPTER				
647-2	1/2" PB x 1/2" FIP	50	50	6.19 EA
647-3	3/4" PB x 3/4" FIP	50	50	8.54 EA
PB x PEX ADAPTER				
645X2G	1/2" PB x 1/2" PEX	50	50	1.63 EA
645X3G	3/4" PB x 3/4" PEX	50	50	2.09 EA
PB x PEX TEE WITH CRIMP RINGS				
641-222X	1/2" PB x 1/2" PB x 1/2" PEX	50	50	4.60 EA
641-332X	3/4" PB x 3/4" PB x 1/2" PEX	50	50	5.49 EA
641-333X	3/4" PB x 3/4" PB x 3/4" PEX	50	50	6.52 EA
PB x CPVC ADAPTER				
645-C2G	1/2" PB x 1/2" CPVC	50	50	5.82 EA
645-C3G	3/4" PB x 3/4" CPVC	50	50	6.05 EA
BALL VALVE				
648-2	1/2" PB ball valve	10	10	14.75 EA
648-3	3/4" PB ball valve	10	10	24.90 EA

Sioux Chief CPVC Fittings

- The widest line of transition fittings in the industry.
- Compatible with FlowGuard Gold® pipe and fittings. FGG/BM® System compatible. Standard solvent weld socket connection.
- Makes CPVC to fixture connections faster, easier and more durable than other transition fittings.
- All fittings are 100% production tested to ensure maximum quality and a leak free connection.
- Pressure tested to over 500 PSI without leaks.
- Thermal cycle tested up to 180°F for 1000 cycles.

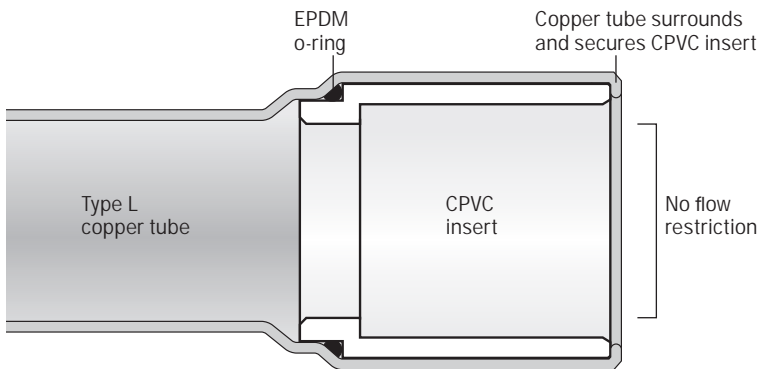

Important Notes about Sioux Chief CPVC Fittings

- All Sioux Chief CPVC fittings conform to ASTM D2846 Standard for CPVC piping systems and are designed for use with any CPVC pipe and fittings conforming to ASTM D2846. A select group of our transition fittings have been tested and certified by CSA to the ASTM D2846 Standard and CSA Standard B137.6 and/or listed by UPC.
- Do not cut, alter or modify any Sioux Chief CPVC transition fitting. Doing so voids the manufacturer's warranty. The only exception is for the 630-C series (p 98) where the spin closed end must be cut off.
- Do not expose CPVC transition area of fitting to heat in excess of 190°F. Excessive heat will distort and deform the CPVC insert and damage the internal o-ring seal. Never install a damaged fitting.
- Perform all solder joints on Sioux Chief ½" and ¾" CPVC transition fittings at a minimum distance of 10" along copper tube from the CPVC transition area. For 1"-2" CPVC transition fittings, temporarily plug CPVC socket with a nipple and cap. Perform all solder joints on Sioux Chief 1"-2" CPVC transition fittings a minimum distance of 18" along the copper tube. If a heat blocker is used, soldering distance may be reduced to 6" for ½" and ¾" CPVC transition fittings and 15" for 1" CPVC transition fittings.



SYSTEM COMPATIBLE

FGG/BM® System Compatible indicates this product has been tested and is monitored on an ongoing basis to assure chemical compatibility with FlowGuard Gold®, BlazeMaster®, and Corzan® pipe and fittings. FGG/BM®, FlowGuard Gold®, BlazeMaster® and Corzan are registered trademarks of Noveon IP Holdings Corp.



SUPPLY
DRAINAGE
SUPPORT
TESTING
SPECIALTIES
TOOLS
ACCESS

SUPPLY



630-C248

DRAINAGE

SUPPORT

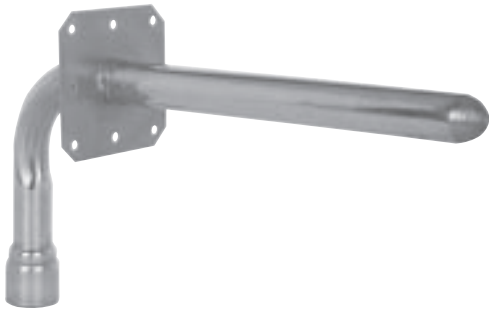

630-C248E

Stub Out Elbow

Standard Square-O Strap

- Accepts sweat and compression stop valves
- Combines the easy installation of CPVC with the strength and versatility of copper
- Spin closed ends are guaranteed leakproof
- Type L copper
- Square O Strap is crimped onto tube

TESTING

Use Caution When Soldering

Keep the following minimum distances between CPVC joints and solder joints:

	No Heat Blocker	With Heat Blocker
½" CTS	10"	6"
¾" CTS	10"	6"
1" CTS	18"	15"

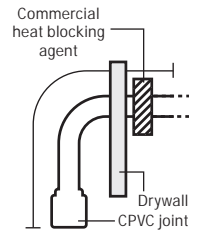

SPECIALTIES



Stub out elbows combine elbow and cap in one quick, easy stub out fitting.

TOOLS

Item No.	Connection	Dimensions				Min. Qty.	Case Qty.	List Price
		A	B	C	D			
STANDARD								
BULK								
630-C248	½" CPVC socket	3½"	8"	1¼"	—	50	50	5.70 EA
630-C2412	½" CPVC socket	3½"	12"	1¼"	—	50	50	7.38 EA
630-C287	½" CPVC socket	8"	7"	1¼"	—	50	50	6.70 EA
630-C348	¾" CPVC socket	6"	8"	1¾"	—	50	50	10.52 EA
630-C3612	¾" CPVC socket	6"	12"	1¾"	—	25	25	13.51 EA
630-C41110	1" CPVC socket	11"	10"	2"	—	25	25	22.63 EA
INDIVIDUALLY BAR-CODED IN A CUT CASE BOX								
630-C248PK	½" CPVC socket	3½"	8"	1¼"	—	10	10	5.84 EA
WITH SQUARE O STRAP								
630-C248E	½" CPVC socket	3½"	8"	1¼"	1¼"	25	25	6.70 EA

ACCESS

Guaranteed Leakproof
Spin closed ends have five times the wall thickness of the copper tube. Each fitting is factory inspected.

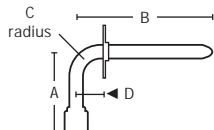

EGG-BM
SYSTEM COMPATIBLE

Tub/Shower Pressure Connector

- Long radius bend for better flow and less noise
- One piece, type L copper
- MIP and FIP swivel connections mean no more torch at the tub/shower valve

Use Caution When Soldering

Whenever possible, solder with CPVC socket facing downward. If CPVC joint is above solder joint, plug temporarily with nipple and cap to prevent chimney effect.

Always apply torch to valve, not to the fitting.

Use a commercial heat blocking agent between solder joint and CPVC joint.

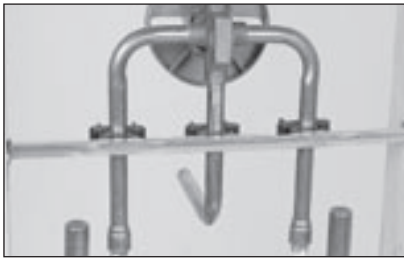
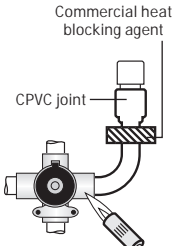

Item No.	Connection	Dimensions		Min. Qty.	Case Qty.	List Price
		A	B			
BULK						
632-C263	1/2" CPVC socket x 1/2" male sweat elbow	6"	2 1/4"	50	50	5.06 EA
632-C283	1/2" CPVC socket x 1/2" male sweat elbow	8"	2 1/4"	50	50	5.35 EA
632-C2123	1/2" CPVC socket x 1/2" male sweat elbow	12"	2 1/4"	50	50	6.70 EA
632-C263X	1/2" CPVC socket x 1/2" MIP swivel elbow	6"	3"	50	50	7.58 EA
632-C263Y	1/2" CPVC socket x 1/2" FIP swivel elbow	6"	3"	50	50	6.36 EA
INDIVIDUALLY BAR-CODED IN A CUT CASE BOX						
632-C263PK	1/2" CPVC socket x 1/2" male sweat elbow	6"	2 1/4"	10	10	5.21 EA
632-C283PK	1/2" CPVC socket x 1/2" male sweat elbow	8"	2 1/4"	10	10	5.60 EA

Tub/Shower Elbow

Shower-lock & Drop-ear Models

- Forged brass, 1/2" FIP thread body with CPVC connection
- Lead-free solder joint
- Shower-lock models for applications with wallboard or fiberglass shower units
- Internal FIP threads accept shower arms or tub nipples

Item No.	Description	Min. Qty.	Case Qty.	List Price
BULK				
616-C2	1/2" CPVC x 1/2" FIP shower-lock elbow with 2" O.D. lock nuts	50	50	11.09 EA
647-C2E	1/2" CPVC x 1/2" FIP drop-ear elbow	50	50	6.88 EA
INDIVIDUALLY BAR-CODED IN A CUT CASE BOX				
616-C2PK	1/2" CPVC x 1/2" FIP shower-lock elbow with 2" O.D. lock nuts	10	10	11.21 EA
647-C2EPK2	1/2" CPVC x 1/2" FIP drop-ear elbow	10	10	7.06 EA

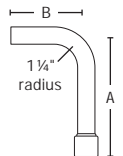

DO NOT use pipe dope on FIP threads



SUPPLY

DRAINAGE

SUPPORT

TESTING

SPECIALTIES

TOOLS

ACCESS

SUPPLY

DRAINAGE

SUPPORT

TESTING

SPECIALTIES

TOOLS

ACCESS

Water Heater Connector

FIP Elbow Fitting

- Full-flow fitting
- FIP swivel nut with gasket is a dielectric fitting
- Fitting with 600 WOG full port ball valve available

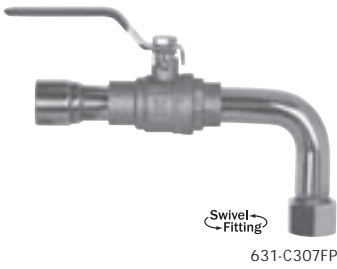

DO NOT use pipe dope on FIP threads



Item No.	Kit Code	Connection	Length	Ball Valve	Min. Qty.	Case Qty.	List Price
BULK							
631-C307	06	3/4" FIP swivel x 3/4" CPVC socket	3" x 7"		25	25	12.06 EA
631-C307FP	01	3/4" FIP swivel x 3/4" CPVC socket	3" x 7"	✓	25	25	26.65 EA

FIP Straight Fitting

- Full-flow fitting
- FIP swivel nut with gasket is a dielectric fitting
- Fitting with 600 WOG full port ball valve available
- 3/4" FIP branch for two gallon expansion tank



DO NOT use pipe dope on FIP threads



Item No.	Kit Code	Connection	Length	Ball Valve	Min. Qty.	Case Qty.	List Price
BULK							
633-C02	31	3/4" FIP swivel x 3/4" CPVC socket	3"		50	50	6.23 EA
633-C09	32	3/4" FIP swivel x 3/4" CPVC socket	9"		25	25	10.79 EA
633-C18	33	3/4" FIP swivel x 3/4" CPVC socket	18"		25	25	15.06 EA
633-C24	35	3/4" FIP swivel x 3/4" CPVC socket	24"		25	25	18.37 EA
633-C418	36	1" FIP swivel x 3/4" CPVC socket	18"		25	25	23.81 EA
633-C424	37	1" FIP swivel x 3/4" CPVC socket	24"		25	25	27.75 EA
633-C09FP	11	3/4" FIP swivel x 3/4" CPVC socket	9"	✓	25	25	24.87 EA
633-C18FP	12	3/4" FIP swivel x 3/4" CPVC socket	18"	✓	25	25	29.21 EA
633-C24FP	14	3/4" FIP swivel x 3/4" CPVC socket	24"	✓	25	25	32.32 EA
633-C418FP	15	1" FIP swivel x 3/4" CPVC socket	18"	✓	25	25	37.40 EA
633-C424FP	16	1" FIP swivel x 3/4" CPVC socket	24"	✓	25	25	40.41 EA
633-C18M3	34	3/4" FIP swivel x 3/4" CPVC socket, with 3/4" MIP branch	18"		25	25	24.83 EA
633-C18FPM3	13	3/4" FIP swivel x 3/4" CPVC socket, with 3/4" MIP branch	18"	✓	25	25	39.31 EA
633-C18FPT	21	3/4" FIP swivel x 3/4" CPVC socket, with 3/4" FIP branch	18"	✓	20	20	43.34 EA
633-C24FPT	22	3/4" FIP swivel x 3/4" CPVC socket, with 3/4" FIP branch	24"	✓	20	20	46.47 EA
633-C18FRV	17	3/4" FIP swivel x 3/4" CPVC socket, with pressure relief 3/8" O.D. compression	18"	✓	10	10	69.82 EA
633-C418FRV	25	1" FIP swivel x 3/4" CPVC socket, with pressure relief 3/8" O.D. compression	18"	✓	10	10	73.39 EA
INDIVIDUALLY BAR-CODED IN A CUT CASE BOX							
633-C02PK	—	3/4" FIP swivel x 3/4" CPVC socket	3"		10	10	6.37 EA
633-C18PK	—	3/4" FIP swivel x 3/4" CPVC socket	18"		10	10	15.43 EA

Water Heater Connector

FIP Flexible Fitting

- Full-flow fitting
- FIP swivel nut with gasket is a dielectric fitting
- Fitting with 600 WOG full port ball valve available

Item No.	Kit Code	Connection	Length	Ball Valve	Min. Qty.	Case Qty.	List Price
634-C118	56	3/4" FIP swivel x 3/4" CPVC socket	18"		25	25	17.71 EA
634-C118FP	51	3/4" FIP swivel x 3/4" CPVC socket	18"	✓	25	25	30.77 EA



MIP Straight Fitting

- Full-flow fitting
- 3/4" FIP branch for two gallon expansion tank
- Fitting with 600 WOG full port ball valve available

Item No.	Kit Code	Connection	Length	Ball Valve	Min. Qty.	Case Qty.	List Price
BULK							
646-C3	71	3/4" MIP x 3/4" CPVC socket	3 1/4"		50	50	5.56 EA
646-C309	76	3/4" MIP x 3/4" CPVC socket	9"		25	25	10.31 EA
646-C318	72	3/4" MIP x 3/4" CPVC socket	18"		25	25	15.20 EA
646-C324	73	3/4" MIP x 3/4" CPVC socket	24"		25	25	19.26 EA
646-C3418	74	1" MIP x 3/4" CPVC socket	18"		25	25	19.38 EA
646-C3424	75	1" MIP x 3/4" CPVC socket	24"		25	25	23.80 EA
646-C309FP	66	3/4" MIP x 3/4" CPVC socket	9"	✓	25	25	21.31 EA
646-C318FP	61	3/4" MIP x 3/4" CPVC socket	18"	✓	25	25	28.76 EA
646-C324FP	63	3/4" MIP x 3/4" CPVC socket	24"	✓	25	25	31.85 EA
646-C3418FP	64	1" MIP x 3/4" CPVC socket	18"	✓	25	25	33.05 EA
646-C3424FP	65	1" MIP x 3/4" CPVC socket	24"	✓	25	25	35.91 EA
646-C318FPT	81	3/4" MIP x 3/4" CPVC socket, with 3/4" FIP branch	18"	✓	20	20	43.27 EA
646-C324FPT	82	3/4" MIP x 3/4" CPVC socket, with 3/4" FIP branch	24"	✓	20	20	46.54 EA
INDIVIDUALLY BAR-CODED IN A CUT CASE BOX							
646-C3PK	—	3/4" MIP x 3/4" CPVC socket	3 1/4"		10	10	5.68 EA
646-C318PK	—	3/4" MIP x 3/4" CPVC socket	18"		10	10	15.36 EA
646-C318FPPK	—	3/4" MIP x 3/4" CPVC socket	18"	✓	10	10	28.91 EA



SUPPLY

DRAINAGE

SUPPORT

TESTING

SPECIALTIES

TOOLS

ACCESS



Wal-Let™ Wall Termination Fitting

- Perfect for connecting sillcocks to CPVC systems
- One-piece, forged brass fitting with rigid mounting plate soldered to copper elbow with lead-free solder

Item No.	Description	Min. Qty.	Case Qty.	List Price
615-C263	½" CPVC × ½" FIP, 6" × 3" elbow	25	25	14.23 EA
615-C264	½" CPVC × ½" MIP, 6" × 3" elbow	25	25	14.33 EA
615-C2113	½" CPVC × ½" MSWT, 11" straight	25	25	16.30 EA



Adapter

Sillcock Adapter

- Perfect for connecting sillcocks to CPVC systems
- Lead-free solder joint

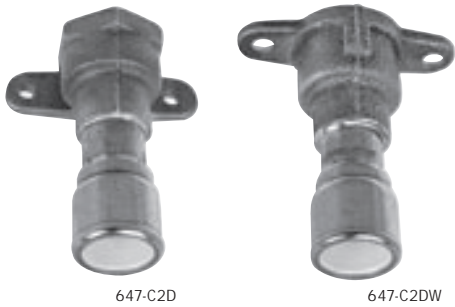

Item No.	Description	Length	Min. Qty.	Case Qty.	List Price
BULK					
647-C2D	½" CPVC × ½" FIP drop-ear	2½"	50	50	14.27 EA
647-C2DW	½" CPVC × ½" FIP wing-ear	2⅝"	50	50	13.83 EA
BAR-CODED BAGS IN A CUT CASE BOX					
647-C2DPK2	½" CPVC × ½" FIP drop-ear, 1/bag	2½"	10	10	14.47 BG
647-C2DWPK2	½" CPVC × ½" FIP wing-ear, 1/bag	2⅝"	10	10	14.00 BG



Short-N-Swivel™ FIP × CPVC Swivel Adapter

- Incredibly versatile and affordable fitting
- One will take the place of up to three expensive union adapters
- Brass swivel nut includes gasket making it a dielectric fitting

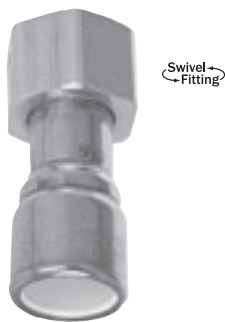

¾" Short-N-Swivel is perfect for hooking up electric water heaters.

Item No.	Connection	Length	Min. Qty.	Case Qty.	List Price
BULK					
637-C20	½" CPVC × ½" FIP swivel	2"	25	25	4.47 EA
633-C02	¾" CPVC × ½" FIP swivel	3"	50	50	6.23 EA
633-C4403	1" CPVC × 1" FIP swivel	3⅞"	20	20	15.77 EA
INDIVIDUALLY BAR-CODED IN A CUT CASE BOX					
637-C20PK2	½" CPVC × ½" FIP swivel	2"	10	10	4.66 EA
633-C02PK	¾" CPVC × ½" FIP swivel	3"	10	10	6.37 EA



DO NOT use pipe dope on FIP threads

Adapter

- MIP × CPVC
- FIP × CPVC
- PEX × CPVC
- Wirsbo® ProPEX® × CPVC
- PB × CPVC

• Lead-free solder joint

1 1/2" & 2" adapters
available Spring 2007



Item No.	Connection	Length	Min. Qty.	Case Qty.	List Price
MIP					
BULK					
646-C2	1/2" CPVC × 1/2" MIP	2 1/2"	50	50	4.26 EA
646-C3	3/4" CPVC × 3/4" MIP	3 1/4"	50	50	5.56 EA
646-C4	1" CPVC × 1" MIP	3 3/4"	20	20	10.99 EA
646-C5	1 1/4" CPVC × 1 1/4" MIP	4 1/4"	10	10	36.45 EA
646-C6	1 1/2" CPVC × 1 1/2" MIP	5"	10	10	48.90 EA
646-C7	2" CPVC × 2" MIP	6"	10	10	75.95 EA
INDIVIDUALLY BAR-CODED IN A CUT CASE BOX					
646-C3PK	3/4" CPVC × 3/4" MIP	3 1/4"	10	10	5.68 EA
BAR-CODED BAGS IN A CUT CASE BOX					
646-C2PK2	1/2" CPVC × 1/2" MIP	2 1/2"	10	10	4.44 BG
FIP					
BULK					
647-C2	1/2" CPVC × 1/2" FIP	2 3/4"	50	50	4.82 EA
647-C3	3/4" CPVC × 3/4" FIP	3 1/4"	50	50	6.87 EA
647-C4	1" CPVC × 1" FIP	3 3/4"	20	20	11.53 EA
647-C5	1 1/4" CPVC × 1 1/4" FIP	4 1/2"	10	10	34.20 EA
647-C6	1 1/2" CPVC × 1 1/2" FIP	5 1/4"	10	10	47.05 EA
647-C7	2" CPVC × 2" FIP	6"	10	10	72.90 EA
BAR-CODED BAGS IN A CUT CASE BOX					
647-C2PK2	1/2" CPVC × 1/2" FIP	2 3/4"	10	10	5.07 BG
647-C3PK2	3/4" CPVC × 3/4" FIP	3 1/4"	10	10	7.05 BG
PEX					
BULK					
645XC2	1/2" CPVC × 1/2" PEX	1 3/8"	50	50	4.32 EA
645XC3	3/4" CPVC × 3/4" PEX	2 3/8"	50	50	5.07 EA
645XC4	1" CPVC × 1" PEX	3 3/8"	20	20	11.97 EA
BAR-CODED BAGS IN A CUT CASE BOX					
645XC2PK2	1/2" CPVC × 1/2" PEX	1 3/8"	10	10	4.52 BG
645XC3PK2	3/4" CPVC × 3/4" PEX	2 3/8"	10	10	5.33 BG
WIRSBO PROPEX					
645WC2	1/2" CPVC × 1/2" ProPEX	1 3/8"	50	50	5.72 EA
645WC3	3/4" CPVC × 3/4" ProPEX	2 3/8"	50	50	7.84 EA
645WC4	1" CPVC × 1" ProPEX	3 3/8"	20	20	14.52 EA
PB					
645-C2G	1/2" CPVC × 1/2" PB	2 5/8"	50	50	5.82 EA
645-C3G	3/4" CPVC × 3/4" PB	3 1/4"	50	50	6.05 EA



SUPPLY

DRAINAGE

SUPPORT

TESTING

SPECIALTIES

TOOLS

ACCESS



Adapter

Male Sweat × CPVC

- Perfect for connecting sillcocks, laundry boxes, water service connections, etc.
- All fittings are production tested to ensure maximum quality and a leak free connection

Use Caution When Soldering

Whenever possible, solder with CPVC socket facing downward. If CPVC joint is above solder joint, plug temporarily with nipple and cap to prevent chimney effect.

Always apply torch to female fitting, not to the adapter.

Use a commercial heat blocking agent between solder joint and CPVC joint.



CAUTION

Do not cut this fitting. Cutting this fitting voids warranty. Do not allow CPVC portion of fitting to be heated. Do not exceed 190°F. Excessive heat can damage the CPVC insert and internal o-ring.



Item No.	Description	Length	Min. Qty.	Case Qty.	List Price
BULK					
643-C211	½" CPVC × ½" MSWT	11"	100	100	6.80 EA
643-C311	¾" CPVC × ¾" MSWT	11"	50	50	9.60 EA
643-C418	1" CPVC × 1" MSWT	18"	25	25	19.52 EA

Brass Ball Valve

- Chrome plated ball, blowout-proof stem
- Lead-free solder joint
- ANSI/NSF 61-8
- C-377 forged brass



Item No.	Connection	Length	Min. Qty.	Case Qty.	List Price
FULL PORT					
648-C2FP	½" CPVC	4 ½"	10	10	16.75 EA
648-C3FP	¾" CPVC	6"	10	10	22.50 EA
648-C4FP	1" CPVC	8"	10	10	41.45 EA
INDIVIDUALLY BAR-CODED IN A CUT CASE BOX					
648-C2FPPK	½" CPVC	4 ½"	10	10	16.86 EA
FULL PORT WITH DRAIN					
648-C2FPD	½" CPVC	4 ½"	10	10	18.46 EA
648-C3FPD	¾" CPVC	6"	10	10	28.75 EA
648-C4FPD	1" CPVC	8"	10	10	47.60 EA



Thermoplastic CPVC Ball Valve

- NSF/ANSI 14
- ASTM D2846 socket joint
- Teflon seat
- EPDM o-rings
- Rated 100 PSI at 180° F

Item No.	Connection	Min. Qty.	Case Qty.	List Price
106-C22	½" CPVC	10	100	5.60 EA
106-C23	¾" CPVC	10	100	7.50 EA
106-C24	1" CPVC	10	100	11.99 EA



Brass Stop & Waste Valve

- Brass valve body with stuffing box, neoprene seals
- Lead-free solder joint
- ANSI/NSF 61-8

Item No.	Connection	Length	Min. Qty.	Case Qty.	List Price
648-C2W	½" CPVC	4¾"	10	10	15.95 EA
648-C3W	¾" CPVC	6¼"	10	10	20.90 EA



Brass Boiler Drain

- Male hose thread spout
- With stuffing box
- Lead-free solder joint
- ANSI/NSF 61-8

Item No.	Connection	Min. Qty.	Case Qty.	List Price
113-C32	½" CPVC	25	25	10.24 EA

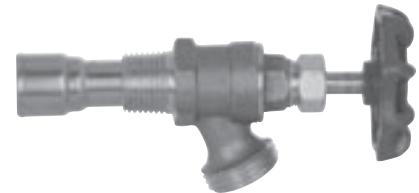

Sillcock

¼-Turn Ball Valve

- Chrome plated brass finish
- 2⅝" diameter mounting flange

Standard Sillcock

- New larger 2⅝" dia. mounting flange
- Lead-free solder joint

Item No.	Connection	Dimensions	Min. Qty.	Case Qty.	List Price
		A			
¼-TURN BALL VALVE					
116-C22	½" CPVC	1⅞"	25	25	15.56 EA
116-C223E	½" CPVC	3⅝"	25	25	16.25 EA
STANDARD SILLCOCK					
117-C22	½" CPVC	1⅞"	25	25	11.91 EA
117-C223E	½" CPVC	3⅝"	25	25	12.53 EA

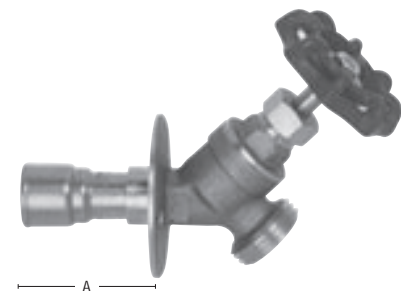
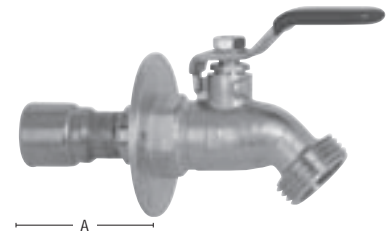

Sioux Chief PVC Fittings

- All PVC fittings are 100% production tested to assure maximum quality and a leak free connection.
- Makes PVC to threaded connection faster, easier and more durable than other transition fittings.
- Sioux Chief PVC transition fittings can be used for potable water or irrigation systems.

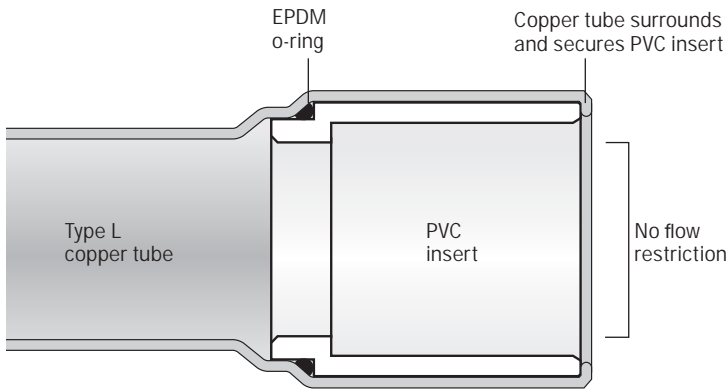

Important Notes about Sioux Chief PVC Fittings

- All Sioux Chief PVC fittings conform to the ASTM F 1970-01 Standard for PVC piping systems and are designed for use with any PVC pipe and fittings conforming to ASTM D 2466-02 PVC Schedule 40.
- Do not cut, alter, or modify any Sioux Chief PVC transition fitting. Doing so voids the manufacturer's warranty.
- Do not expose PVC transition area of fitting to heat in excess of 140°F. Excessive heat will distort and deform the PVC insert and damage the internal o-ring. Never install a damaged fitting.



SUPPLY
DRAINAGE
SUPPORT
TESTING
SPECIALTIES
TOOLS
ACCESS

MIP 646-P6,-P7 and
FIP 647-P6,-P7
Available Spring 2007



646-P3



647-P3

PVC Adapter

MIP × PVC

FIP × PVC

- A perfect fitting to transition from a PVC service line to a threaded adapter for CPVC, copper, or PEX piping system
- Great transition fitting for irrigation systems
- Lead-free solder joint

Item No.	Description	Min. Qty.	Case Qty.	List Price
MIP				
646-P3	¾" PVC × ¾" MIP adapter	50	50	8.46 EA
646-P4	1" PVC × 1" MIP adapter	20	20	14.00 EA
NEW 646-P5	1¼" PVC × 1¼" MIP adapter	10	10	18.65 EA
NEW 646-P6	1½" PVC × 1½" MIP adapter	10	10	54.85 EA
NEW 646-P7	2" PVC × 2" MIP adapter	10	10	72.65 EA
FIP				
647-P3	¾" PVC × ¾" FIP adapter	50	50	9.46 EA
647-P4	1" PVC × 1" FIP adapter	20	20	16.14 EA
NEW 647-P5	1¼" PVC × 1¼" FIP adapter	10	10	20.02 EA
NEW 647-P6	1½" PVC × 1½" FIP adapter	10	10	57.00 EA
NEW 647-P7	2" PVC × 2" FIP adapter	10	10	80.00 EA

Brass Ball Valve

PVC Socket Connection

- Chrome plated ball, blowout-proof stem
- Lead-free solder joint
- ¼ turn full-port ball valve



648-P3FP

Item No.	Description	Min. Qty.	Case Qty.	List Price
648-P3FP	¾" PVC	10	10	23.75 EA
648-P4FP	1" PVC	10	10	42.55 EA

NEW Thermoplastic Ball Valve

Socket or Threaded

- Solvent ends comply with ASTM D2466
- Threaded ends comply with ANSI B 1.20.1
- Rated 150 PSI at 73°F
- NSF approved
- EPDM seats and o-rings
- For use with Sch. 40 and Sch. 80
- Cold water use only
- Standard port



Item No.	Description	Min. Qty.	Case Qty.	List Price
SOCKET				
106-22	½" PVC ball valve	10	100	2.68 EA
106-23	¾" PVC ball valve	10	100	3.56 EA
106-24	1" PVC ball valve	5	50	5.01 EA
106-25	1¼" PVC ball valve	5	50	7.26 EA
106-26	1½" PVC ball valve	4	24	10.08 EA
106-27	2" PVC ball valve	4	24	12.65 EA
THREADED				
106-12	½" PVC ball valve, FIP	10	100	2.77 EA
106-13	¾" PVC ball valve, FIP	10	100	3.75 EA
106-14	1" PVC ball valve, FIP	5	50	5.20 EA
106-15	1¼" PVC ball valve, FIP	5	50	7.43 EA
106-16	1½" PVC ball valve, FIP	4	24	10.42 EA
106-17	2" PVC ball valve, FIP	4	24	12.92 EA

NEW PVC Double Union Ball Valve

- Both FIP and solvent weld union adapters included with each valve
- Solvent ends comply with ASTM D2466
- Threaded ends comply with ANSI B 1.20.1
- Rated 150 PSI at 73°F
- Teflon seats and EPDM o-rings
- For use with Sch. 40 and Sch. 80
- Cold water use only



Item No.	Description	Min. Qty.	Case Qty.	List Price
107-12	½" PVC ball valve	12	72	9.08 EA
107-13	¾" PVC ball valve	12	60	11.99 EA
107-14	1" PVC ball valve	5	45	17.40 EA
107-15	1¼" PVC ball valve	4	24	26.06 EA
107-16	1½" PVC ball valve	4	16	34.72 EA
107-17	2" PVC ball valve	4	12	46.85 EA

SUPPLY

DRAINAGE

SUPPORT

TESTING

SPECIALTIES

TOOLS

ACCESS

Kits

Shower-Up
Water Heater
Tankless Water Heater
Heating Coil Loop

SUPPLY

DRAINAGE

SUPPORT

TESTING

SPECIALTIES

TOOLS

ACCESS



SUPPLY
DRAINAGE
SUPPORT
TESTING
SPECIALTIES
TOOLS
ACCESS

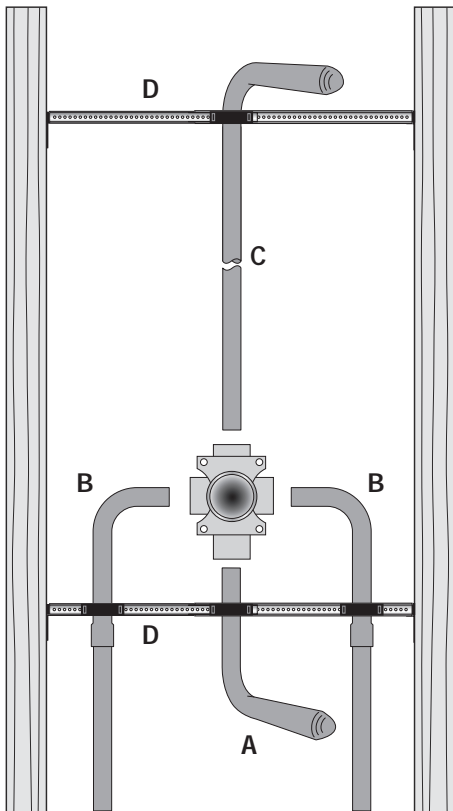

- A** Tub Spout Elbow
- B** Tub/Shower Pressure Connector
- C** Shower Riser
- D** Power Bar Bracket
Adjusts 14"-26"

Related Products
More detail on components p 17

Shower-Up™ Shower Tree Assembly System for Sweat

- Manage materials more easily
- Save labor
- Prevent leaks by using preformed copper

Kits for Site Plumbed Jobs

- Kits bagged individually, shipped 12 to a box
- Order components by kit number, add prices for total list price

Build Kit Item Numbers

Component	A	B	C	D	Shower-Up Kit 693-A B C D
Kit Code	02	22	63	01	693-02 22 63 01
Description	5" x 7" MIP	6" x 3" MIP x FSWT	50" x 8" MIP elbow	Power Bar set	
Price	7.23	13.30	22.48	8.50	51.51 kT

Bulk for Fab Shops

- Order components by bulk number, add prices for total list price

Component	A	B	C	D	Shower-Up Bulk
Item Number	613-57X	609-L263X	608-L2508X	523-2414 523-2434	Bulk Numbers
Description	5" x 7" MIP	6" x 3" MIP x FSWT	50" x 8" MIP elbow	Power Bar set	
Price	7.23	13.30	22.48	10.80	53.81 kT

Copper System Male Sweat Connection

A Tub Spout Elbow

- 1/2" male sweat connection

Description	KIT		BULK		Min./Case Qty.
	Kit Code	Kit List Price	Bulk Item No.	Bulk List Price	
None (for shower only)	01	—	—	—	—
5" x 7"	11	3.79 EA	613-57	3.79 EA	50
6" x 7"	12	4.05 EA	613-67	4.05 EA	50
8" x 7"	13	4.62 EA	613-87	4.62 EA	50
13" x 7"	14	6.30 EA	613-137	6.30 EA	50
13" x 9"	15	6.85 EA	613-139	6.85 EA	50
10" x 7"	16	5.43 EA	613-107	5.43 EA	50



B Tub/Shower Pressure Connector

- 1/2" male sweat connection

Description	KIT		BULK		Min./Case Qty.
	Kit Code	Kit List Price	Bulk Item No.	Bulk List Price	
1/2" FSWT, 6" x 2 1/4" elbow	21	6.36 EA	609-L263A	3.18 EA	50
1/2" FSWT, 12" air chamber tee	24	19.54 EA	682-L5113	9.77 EA	25
1/2" FSWT, Mini-Rester tee	61	37.00 EA	660-TS	18.50 EA	25



Kit Code 21
609-L263A



Kit Code 61
660-TS

C Shower Riser

- 1/2" male sweat connection (except when noted)

Description	KIT		BULK		Min./Case Qty.
	Kit Code	Kit List Price	Bulk Item No.	Bulk List Price	
FOR USE WITH COPPER RISERS					
1/2" FSWT, 3 1/2" x 8" stub out elbow	21	3.62 EA	609-L248	3.62 EA	50
Above fitting with Square O Strap	22	4.62 EA	609-L248E	4.62 EA	25
1/2" FSWT drop-ear elbow	23	3.78 EA	616-2E	3.78 EA	50
FULL-LENGTH COPPER RISERS					
30" riser with drop-ear elbow	31	15.31 EA	616-630	15.31 EA	50
50" riser with drop-ear elbow	32	20.37 EA	616-650	20.37 EA	25
30" riser x 8" stub out elbow	51	13.31 EA	608-L2308	13.31 EA	25
above riser with Square O Strap	52	14.31 EA	608-L2308E	14.31 EA	25
50" riser x 8" stub out elbow	53	19.19 EA	608-L2508	19.19 EA	25
above riser with Square O Strap	54	20.19 EA	608-L2508E	20.19 EA	25



Kit Code 22
609-L248E



Kit Code 23
616-2E



Kit Code 31
616-630

D Power Bar Bracket

Description	KIT		BULK		Min./Case Qty.
	Kit Code	Kit List Price	Bulk Item No.	Bulk List Price	
Power Bar, 1 TD clamp, 4 screws	01	8.50 EA	523-2414	4.80 EA	50
Power Bar, 3 TD clamps, 4 screws			523-2434	6.00 EA	50
Power Bar, 6 screws	02	8.50 EA	523-2404	4.25 EA	50
Power Bar, 2 TD clamps, 4 screws			523-2424	5.25 EA	50
Power Bar, 6 screws	03	8.50 EA	523-2404	4.25 EA	50
Power Bar, 3 TD clamps, 4 screws			523-2434	6.00 EA	50
Power Bar, 1 TD clamp, 4 screws	04	8.50 EA	523-2414	4.80 EA	50
Power Bar, 2 TD clamps, 4 screws			523-2424	5.25 EA	50

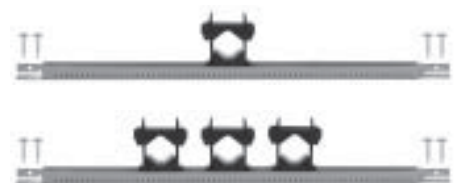

Copper System MIP Connection

SUPPLY

DRAINAGE

SUPPORT

TESTING

SPECIALTIES

TOOLS

ACCESS

A Tub Spout Elbow

• 1/2" MIP fixed or swivel connection

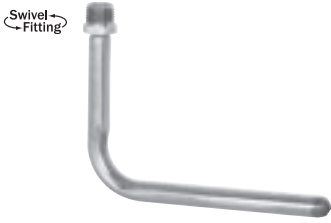

Description	KIT		BULK		
	Kit Code	Kit List Price	Bulk Item No.	Bulk List Price	Min./Case Qty.
None (for shower only)	01	—	—	—	—
5" x 7", swivel connection	02	7.23 EA	613-57X	7.23 EA	50
6" x 7", swivel connection	03	7.27 EA	613-67X	7.27 EA	50
8" x 7", swivel connection	04	8.18 EA	613-87X	8.18 EA	50
5 1/2" x 7", fixed connection	05	6.37 EA	613-57M	6.37 EA	50
6 1/2" x 7", fixed connection	06	6.58 EA	613-67M	6.58 EA	50
8 1/2" x 7", fixed connection	07	7.09 EA	613-87M	7.09 EA	50

B Tub/Shower Pressure Connector

• 1/2" MIP swivel connection



Description	KIT		BULK		
	Kit Code	Kit List Price	Bulk Item No.	Bulk List Price	Min./Case Qty.
1/2" FSWT, 6" x 3" elbow	22	13.30 EA	609-L263X	6.65 EA	50

C Shower Riser

• 1/2" MIP swivel connection



Description	KIT		BULK		
	Kit Code	Kit List Price	Bulk Item No.	Bulk List Price	Min./Case Qty.
30" with drop-ear elbow	41	19.10 EA	616-630X	19.10 EA	50
50" with drop-ear elbow	42	24.19 EA	616-650X	24.19 EA	25
30" x 8" stub out elbow above riser with Square O Strap	62	17.39 EA	608-L2308EX	17.39 EA	25
50" x 8" stub out elbow above riser with Square O Strap	64	23.48 EA	608-L2508EX	23.48 EA	25

D Power Bar Bracket

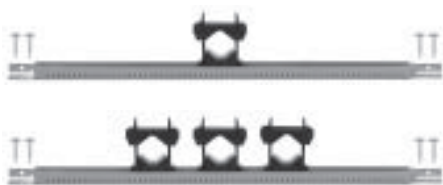

Description	KIT		BULK		
	Kit Code	Kit List Price	Bulk Item No.	Bulk List Price	Min./Case Qty.
Power Bar, 1 TD clamp, 4 screws	01	8.50 EA	523-2414	4.80 EA	50
Power Bar, 3 TD clamps, 4 screws			523-2434	6.00 EA	50
Power Bar, 6 screws	02	8.50 EA	523-2404	4.25 EA	50
Power Bar, 2 TD clamps, 4 screws			523-2424	5.25 EA	50
Power Bar, 6 screws	03	8.50 EA	523-2404	4.25 EA	50
Power Bar, 3 TD clamps, 4 screws			523-2434	6.00 EA	50
Power Bar, 1 TD clamp, 4 screws	04	8.50 EA	523-2414	4.80 EA	50
Power Bar, 2 TD clamps, 4 screws			523-2424	5.25 EA	50

Copper System FIP Connection

DO NOT use pipe
dope on FIP threads

A Tub Spout Elbow

- 1/2" FIP swivel connection

Description	KIT		BULK		
	Kit Code	Kit List Price	Bulk Item No.	Bulk List Price	Min./Case Qty.
None (for shower only)	01	—	—	—	—
5" x 7" Tub Spout elbow	31	6.12 EA	613-57Y	6.12 EA	50
6" x 7" Tub Spout elbow	32	6.15 EA	613-67Y	6.15 EA	50
8" x 7" Tub Spout elbow	33	7.13 EA	613-87Y	7.13 EA	50



B Tub/Shower Pressure Connector

- 1/2" FIP swivel connection

Description	KIT		BULK		
	Kit Code	Kit List Price	Bulk Item No.	Bulk List Price	Min./Case Qty.
1/2" FSWT, 6" x 3" elbow	23	10.94 EA	609-L263Y	5.47 EA	50
1/2" FSWT, Mini-Rester tee	62	42.50 EA	660-TSF7	21.25 EA	25



C Shower Riser

- 1/2" FIP swivel connection

Description	KIT		BULK		
	Kit Code	Kit List Price	Bulk Item No.	Bulk List Price	Min./Case Qty.
30", with drop-ear elbow	43	17.82 EA	616-630Y	17.82 EA	50
50", with drop-ear elbow	44	22.90 EA	616-650Y	22.90 EA	25
30" x 8" stub out elbow	71	15.87 EA	608-L2308Y	15.87 EA	25
above riser with Square O Strap	72	16.87 EA	608-L2308EY	16.87 EA	25
50" x 8" stub out elbow	73	22.54 EA	608-L2508Y	22.54 EA	25
above riser with Square O Strap	74	23.54 EA	608-L2508EY	23.54 EA	25



D Power Bar Bracket

Description	KIT		BULK		
	Kit Code	Kit List Price	Bulk Item No.	Bulk List Price	Min./Case Qty.
Power Bar, 1 TD clamp, 4 screws	01	8.50 EA	523-2414	4.80 EA	50
Power Bar, 3 TD clamps, 4 screws			523-2434	6.00 EA	50
Power Bar, 6 screws	02	8.50 EA	523-2404	4.25 EA	50
Power Bar, 2 TD clamps, 4 screws			523-2424	5.25 EA	50
Power Bar, 6 screws	03	8.50 EA	523-2404	4.25 EA	50
Power Bar, 3 TD clamps, 4 screws			523-2434	6.00 EA	50
Power Bar, 1 TD clamp, 4 screws	04	8.50 EA	523-2414	4.80 EA	50
Power Bar, 2 TD clamps, 4 screws			523-2424	5.25 EA	50

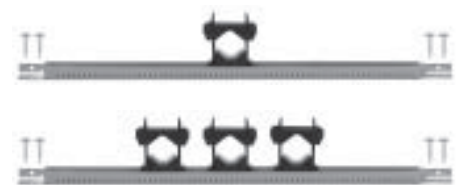

Shower-Up Kits

CATALOG 2007

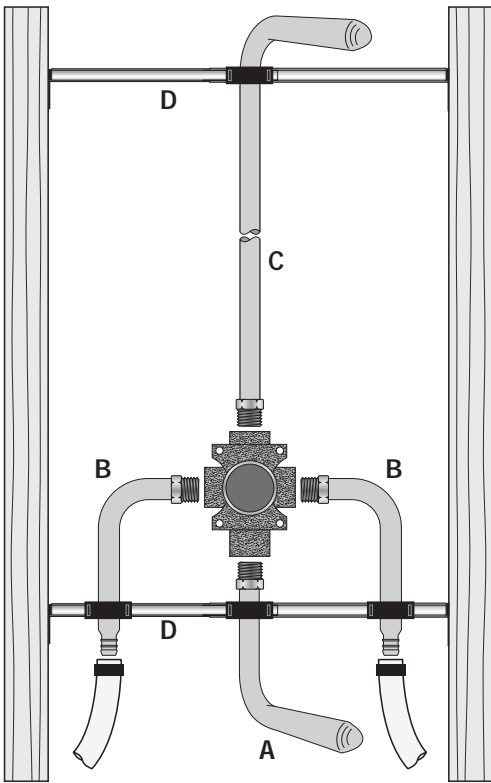

Shower-Up™ Shower Tree Assembly System for PEX

- Manage materials more easily
- Save labor
- Prevent leaks by using preformed copper

Kits for Site Plumbed Jobs

- Kits bagged individually, shipped 12 to a box
- Order components by kit number, add prices for total list price

Build Kit Item Numbers

Component	A	B	C	D	Shower-Up Kit 693-A B C D
Kit Code	03	12	63	01	693-03 12 63 01
Description	6" x 7" MIP	6" x 3" MIP x PEX	50" x 8" MIP elbow	Power Bar set	
Price	7.27	13.66	22.48	8.50	51.91 kT

Most Popular Kits

Item No.	Components	Min. Qty.	Case Qty.	List Price
693-14155303	13" x 7" MSWT tub spout elbow 6" x 3" PEX x MSWT pressure connectors 50" x 8" MSWT elbow shower riser Power Bar set	12	12	41.53 kT
693-13155301	8" x 7" MSWT tub spout elbow 6" x 3" PEX x MSWT pressure connectors 50" x 8" MSWT elbow shower riser Power Bar set	12	12	39.85 kT

- A** Tub Spout Elbow
- B** Tub/Shower Pressure Connector
- C** Shower Riser
- D** Power Bar Bracket
Adjusts 14"-26"

Related Products
More detail on components p 36

Bulk for Fab Shops

- Order components by bulk number, add prices for total list price

Component	A	B	C	D	Shower-Up Bulk
Item Number	613-67X	632X263X	608-L2508X	523-2414 523-2434	Bulk Numbers
Description	6" x 7" MIP	6" x 3" MIP x PEX	50" x 8" MIP elbow	Power Bar set	
Price	7.27	13.66	22.48	10.80	54.21 kT

SUPPLY

DRAINAGE

SUPPORT

TESTING

SPECIALTIES

TOOLS

ACCESS

PEX System Sweat Connection

A Tub Spout Elbow

- 1/2" male sweat connection

Description	KIT		BULK		
	Kit Code	Kit List Price	Bulk Item No.	Bulk List Price	Min./Case Qty.
None(for shower only)	01	—	—	—	—
5" x 7"	11	3.79 EA	613-57	3.79 EA	50
6" x 7"	12	4.05 EA	613-67	4.05 EA	50
8" x 7"	13	4.62 EA	613-87	4.62 EA	50
13" x 7"	14	6.30 EA	613-137	6.30 EA	50
13" x 9"	15	6.85 EA	613-139	6.85 EA	50
10" x 7"	16	5.43 EA	613-107	5.43 EA	50



B Tub/Shower Pressure Connector

- 1/2" male sweat connection

Description	KIT		BULK		
	Kit Code	Kit List Price	Bulk Item No.	Bulk List Price	Min./Case Qty.
1/2" PEX x MSWT, 4" x 2 1/4" elbow	14	4.96 EA	632X243	2.48 EA	50
1/2" PEX x MSWT, 6" x 2 1/4" elbow	15	6.04 EA	632X263	3.02 EA	50
1/2" PEX x MSWT, short elbow	16	4.30 EA	632X222	2.15 EA	1000
1/2" PEX x MSWT, 12" air chamber tee	17	20.84 EA	682XL5213	10.42 EA	25
1/2" PEX, Mini-Rester tee	63	45.00 EA	660-TSX	22.50 EA	25
1/2" ProPEX x MSWT, 7" x 3" elbow	71	12.64 EA	632W273	6.32 EA	50



Kit Code 16
632X222

Kit Code 14
632X243

C Shower Riser

- 1/2" male sweat connection

Description	KIT		BULK		
	Kit Code	Kit List Price	Bulk Item No.	Bulk List Price	Min./Case Qty.
FOR USE WITH PEX RISER					
1/2" PEX x MSWT adapter	17	4.43 EA	643X2	0.65 EA	100/1000
1/2" PEX x 3 1/2" x 8" stub out elbow			630X248	3.78 EA	50
1/2" PEX x MSWT adapter	18	5.43 EA	643X2	0.65 EA	100/1000
1/2" PEX x 3 1/2" x 8" Square O elbow			630X248E	4.78 EA	25
1/2" PEX x MSWT adapter	19	5.37 EA	643X2	0.65 EA	100/1000
1/2" PEX drop-ear elbow			647X2E	4.72 EA	50
FOR USE WITH COPPER RISER					
1/2" FSWT, 3 1/2" x 8" stub out elbow	21	3.62 EA	609-L248	3.62 EA	50
above fitting with Square O Strap	22	4.62 EA	609-L248E	4.62 EA	25
1/2" FSWT drop-ear elbow	23	3.78 EA	616-2E	3.78 EA	50
FULL-LENGTH COPPER RISER					
1/2" MSWT, 30" with drop-ear elbow	31	15.31 EA	616-630	15.31 EA	50
1/2" MSWT, 50" with drop-ear elbow	32	20.37 EA	616-650	20.37 EA	25
1/2" MSWT, 30" x 8" stub out elbow	51	13.31 EA	608-L2308	13.31 EA	25
above riser with Square O Strap	52	14.31 EA	608-L2308E	14.31 EA	25
1/2" MSWT, 50" x 8" stub out elbow	53	19.19 EA	608-L2508	19.19 EA	25
above riser with Square O Strap	54	20.19 EA	608-L2508E	20.19 EA	25



Kit Code 17
630X248
643X2

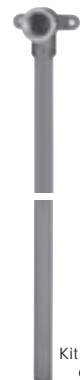

Kit Code 31
616-630



Kit Code 23
616-2E

D Power Bar Bracket

Description	KIT		BULK		
	Kit Code	Kit List Price	Bulk Item No.	Bulk List Price	Min./Case Qty.
Power Bar, 1 TD clamp, 4 screws	01	8.50 EA	523-2414	4.80 EA	50
Power Bar, 3 TD clamps, 4 screws			523-2434	6.00 EA	50
Power Bar, 6 screws	02	8.50 EA	523-2404	4.25 EA	50
Power Bar, 2 TD clamps, 4 screws			523-2424	5.25 EA	50
Power Bar, 6 screws	03	8.50 EA	523-2404	4.25 EA	50
Power Bar, 3 TD clamps, 4 screws			523-2434	6.00 EA	50
Power Bar, 1 TD clamp, 4 screws	04	8.50 EA	523-2414	4.80 EA	50
Power Bar, 2 TD clamps, 4 screws			523-2424	5.25 EA	50

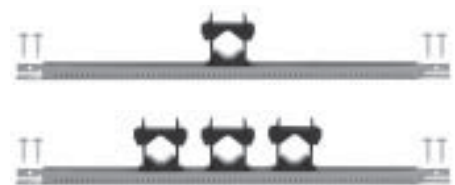

PEX System MIP Connection

A Tub Spout Elbow

- 1/2" MIP swivel or fixed connection



Description	KIT		BULK		
	Kit Code	Kit List Price	Bulk Item No.	Bulk List Price	Min./Case Qty.
None (for shower only)	01	—	—	—	—
5" x 7", swivel connection	02	7.23 EA	613-57X	7.23 EA	50
6" x 7", swivel connection	03	7.27 EA	613-67X	7.27 EA	50
8" x 7", swivel connection	04	8.18 EA	613-87X	8.18 EA	50
5 1/2" x 7", fixed connection	05	6.37 EA	613-57M	6.37 EA	50
6 1/2" x 7", fixed connection	06	6.58 EA	613-67M	6.58 EA	50
8 1/2" x 7", fixed connection	07	7.09 EA	613-87M	7.09 EA	50

B Tub/Shower Pressure Connector



Description	KIT		BULK		
	Kit Code	Kit List Price	Bulk Item No.	Bulk List Price	Min./Case Qty.
1/2" PEX x MIP adapter	11	5.24 EA	646X2	2.62 EA	100
1/2" PEX x MIP swivel, 6" x 3" elbow	12	13.66 EA	632X263X	6.83 EA	50
1/2" PEX x MIP short elbow	13	10.50 EA	632X222M	5.25 EA	50
1/2" ProPEX x MIP swivel, 7" x 3" elbow	72	19.56 EA	632W273X	9.78 EA	50

C Shower Riser

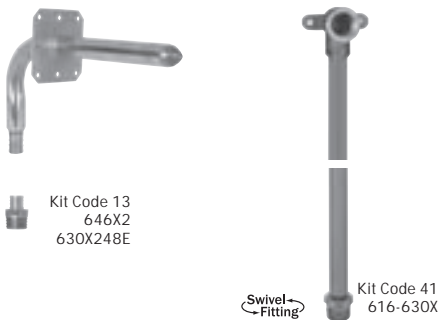

Description	KIT		BULK		
	Kit Code	Kit List Price	Bulk Item No.	Bulk List Price	Min./Case Qty.
FOR USE WITH PEX RISER					
1/2" PEX x MIP adapter	11	7.34 EA	646X2	2.62 EA	100
1/2" PEX drop-ear elbow			647X2E	4.72 EA	50
1/2" PEX x MIP adapter	12	6.40 EA	646X2	2.62 EA	100
1/2" PEX x 3 1/2" x 8" Stub Out elbow			630X248	3.78 EA	50
1/2" PEX x MIP adapter	13	7.40 EA	646X2	2.62 EA	100
1/2" PEX x 3 1/2" x 8" Square O elbow			630X248E	4.78 EA	25
FULL LENGTH COPPER RISER					
1/2" MIP swivel, 30" with drop-ear elbow	41	19.10 EA	616-630X	19.10 EA	50
1/2" MIP swivel, 50" with drop-ear elbow	42	24.19 EA	616-650X	24.19 EA	25
1/2" MIP swivel, 30" x 8" stub out elbow	61	16.39 EA	608-L2308X	16.39 EA	25
above riser with Square O Strap	62	17.39 EA	608-L2308EX	17.39 EA	25
1/2" MIP swivel, 50" x 8" stub out elbow	63	22.48 EA	608-L2508X	22.48 EA	25
above riser with Square O Strap	64	23.48 EA	608-L2508EX	23.48 EA	25

D Power Bar Bracket

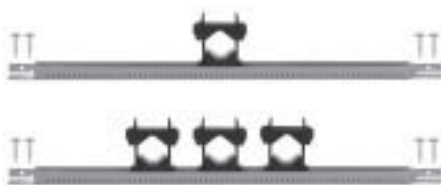

Description	KIT		BULK		
	Kit Code	Kit List Price	Bulk Item No.	Bulk List Price	Min./Case Qty.
Power Bar, 1 TD clamp, 4 screws	01	8.50 EA	523-2414	4.80 EA	50
Power Bar, 3 TD clamps, 4 screws			523-2434	6.00 EA	50
Power Bar, 6 screws	02	8.50 EA	523-2404	4.25 EA	50
Power Bar, 2 TD clamps, 4 screws			523-2424	5.25 EA	50
Power Bar, 6 screws	03	8.50 EA	523-2404	4.25 EA	50
Power Bar, 3 TD clamps, 4 screws			523-2434	6.00 EA	50
Power Bar, 1 TD clamp, 4 screws	04	8.50 EA	523-2414	4.80 EA	50
Power Bar, 2 TD clamps, 4 screws			523-2424	5.25 EA	50

PEX System FIP Connection

A Tub Spout Elbow

- 1/2" FIP swivel connection

Description	KIT		BULK		
	Kit Code	Kit List Price	Bulk Item No.	Bulk List Price	Min./Case Qty.
None (for shower only)	01	—	—	—	—
5" x 7"	31	6.12 EA	613-57Y	6.12 EA	50
6" x 7"	32	6.15 EA	613-67Y	6.15 EA	50
8" x 7"	33	7.13 EA	613-87Y	7.13 EA	50

DO NOT use pipe dope on FIP threads



B Tub/Shower Pressure Connector

Description	KIT		BULK		
	Kit Code	Kit List Price	Bulk Item No.	Bulk List Price	Min./Case Qty.
1/2" PEX x FIP adapter	51	7.70 EA	647X2	3.85 EA	50/250
1/2" PEX x FIP swivel, 6" x 3" elbow	52	11.14 EA	632X263Y	5.57 EA	50
1/2" PEX x 1/2" FIP swivel, Mini-Rester tee	64	41.50 EA	660-TSX7	20.75 EA	25



C Shower Riser

Description	KIT		BULK		
	Kit Code	Kit List Price	Bulk Item No.	Bulk List Price	Min./Case Qty.
FOR USE WITH PEX RISER					
1/2" PEX x FIP adapter	14	8.57 EA	647X2	3.85 EA	50/250
1/2" PEX drop-ear elbow			647X2E	4.72 EA	50
1/2" PEX x FIP adapter	15	7.63 EA	647X2	3.85 EA	50/250
1/2" PEX, 3 1/2" x 8" stub out elbow			630X248	3.78 EA	50
1/2" PEX x FIP adapter	16	8.63 EA	647X2	3.85 EA	50/250
1/2" PEX, 3 1/2" x 8" Square O elbow			630X248E	4.78 EA	25
FULL LENGTH COPPER RISER					
1/2" FIP swivel, 30" with drop-ear elbow	43	17.82 EA	616-630Y	17.82 EA	50
1/2" FIP swivel, 50" with drop-ear elbow	44	22.90 EA	616-650Y	22.90 EA	25
1/2" FIP swivel, 30" x 8" stub Out elbow	71	15.87 EA	608-L2308Y	15.87 EA	25
above riser with Square O Strap	72	16.87 EA	608-L2308EY	16.87 EA	25
1/2" FIP swivel, 50" x 8" stub out elbow	73	22.54 EA	608-L2508Y	22.54 EA	25
above riser with Square O Strap	74	23.54 EA	608-L2508EY	23.54 EA	25

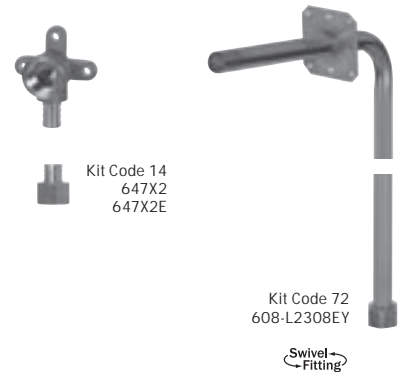

Kit Code 14
647X2
647X2E

Kit Code 72
608-L2308EY

D Power Bar Bracket

Description	KIT		BULK		
	Kit Code	Kit List Price	Bulk Item No.	Bulk List Price	Min./Case Qty.
Power Bar, 1 TD clamp, 4 screws	01	8.50 EA	523-2414	4.80 EA	50
Power Bar, 3 TD clamps, 4 screws			523-2434	6.00 EA	50
Power Bar, 6 screws	02	8.50 EA	523-2404	4.25 EA	50
Power Bar, 2 TD clamps, 4 screws			523-2424	5.25 EA	50
Power Bar, 6 screws	03	8.50 EA	523-2404	4.25 EA	50
Power Bar, 3 TD clamps, 4 screws			523-2434	6.00 EA	50
Power Bar, 1 TD clamp, 4 screws	04	8.50 EA	523-2414	4.80 EA	50
Power Bar, 2 TD clamps, 4 screws			523-2424	5.25 EA	50

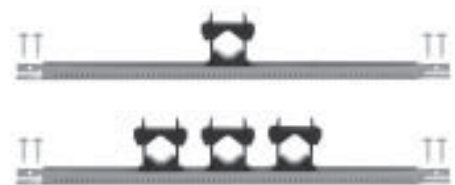

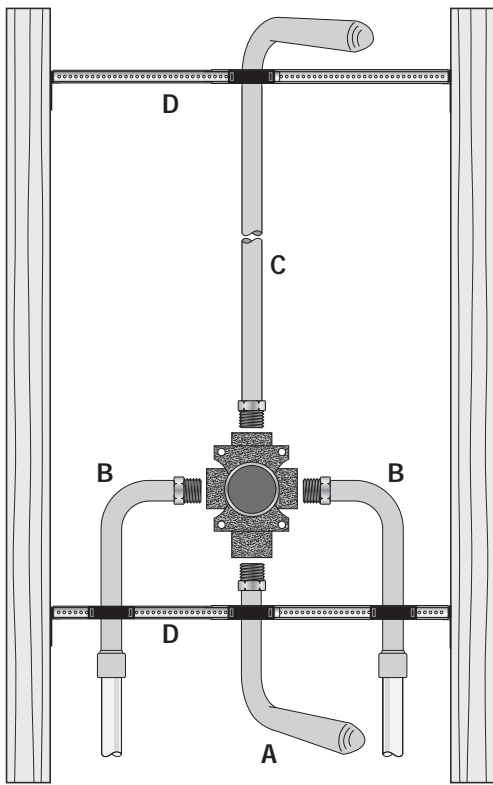

- A** Tub Spout Elbow
- B** Tub/Shower Pressure Connector
- C** Shower Riser
- D** Power Bar Bracket
Adjusts 14"–26"

Related Products
More detail on components p 51

Shower-Up™ Shower Tree Assembly System for CPVC

- Manage materials more easily
- Save labor
- Prevent leaks by using preformed copper

Kits for Site Plumbed Jobs

- Kits bagged individually, shipped 12 to a box
- Order components by kit number, add prices for total list price

Build Kit Item Numbers

Component	A	B	C	D	Shower-Up Kit 693-A B C D
Kit Code	03	02	63	01	693-03 02 63 01
Description	6" × 7" MIP	6" × 3" MIP × CPVC	50" × 8" MIP elbow	Power Bar set	
Price	7.27	15.16	22.48	8.50	53.41 kT

Most Popular Kits

Item No.	Components	Min. Qty.	Case Qty.	List Price
693-06024203	6½" × 7" MIP tub spout elbow 6" × 3" CPVC × MIP swivel pressure connectors 50" MIP swivel riser with drop-ear elbow Power Bar set	12	12	55.93 kT
693-01024102	no tub spout elbow 6" × 3" CPVC × MIP swivel pressure connectors 30" MIP swivel riser with drop-ear elbow Power Bar set	12	12	44.26 kT
693-02016403	6" × 7" MIP tub spout elbow CPVC × MIP adapter 50" × 8" MIP swivel riser elbow with Square O Power Bar set	12	12	49.23 kT
693-32434403	6" × 7" FIP swivel tub spout elbow 6" × 3" CPVC × FIP swivel pressure connectors 50" FIP swivel riser with drop-ear elbow Power Bar set	12	12	51.77 kT

Bulk for Fab Shops

- Order components by bulk number, add prices for total list price

Component	A	B	C	D	Shower-Up Bulk
Item Number	613-67X	632-C263X	608-L2508X	523-2414 523-2434	Bulk Numbers
Description	6" × 7" MIP	6" × 3" MIP × CPVC	50" × 8" MIP elbow	Power Bar set	
Price	7.27	15.16	22.48	10.80	55.71 kT

SUPPLY

DRAINAGE

SUPPORT

TESTING

SPECIALTIES

TOOLS

ACCESS

CPVC System Sweat Connection

A Tub Spout Elbow

• 1/2" male sweat connection

Description	KIT		BULK		
	Kit Code	Kit List Price	Bulk Item No.	Bulk List Price	Min./Case Qty.
None (for shower only)	01	—	—	—	—
5" x 7"	11	3.79 EA	613-57	3.79 EA	50
6" x 7"	12	4.05 EA	613-67	4.05 EA	50
8" x 7"	13	4.62 EA	613-87	4.62 EA	50
13" x 7"	14	6.30 EA	613-137	6.30 EA	50
13" x 9"	15	6.85 EA	613-139	6.85 EA	50
10" x 7"	16	5.43 EA	613-107	5.43 EA	50



B Tub/Shower Pressure Connector

• 1/2" male sweat connection

Description	KIT		BULK		
	Kit Code	Kit List Price	Bulk Item No.	Bulk List Price	Min./Case Qty.
1/2" CPVC, 6" x 2 1/4" elbow	03	10.12 EA	632-C263	5.06 EA	50
1/2" CPVC, 8" x 2 1/4" elbow	04	10.70 EA	632-C283	5.35 EA	50
1/2" CPVC, 12" x 2 1/4" elbow	05	13.40 EA	632-C2123	6.70 EA	50

C Shower Riser

Description	KIT		BULK		
	Kit Code	Kit List Price	Bulk Item No.	Bulk List Price	Min./Case Qty.
FOR USE WITH COPPER RISERS					
1/2" FSWT, 3 1/2" x 8" stub out elbow	21	3.62 EA	609-L248	3.62 EA	50
Above fitting with Square O Strap	22	4.62 EA	609-L248E	4.62 EA	25
1/2" FSWT drop-ear elbow	23	3.78 EA	616-2E	3.78 EA	50
FULL-LENGTH COPPER RISERS					
30" riser with drop-ear elbow	31	15.31 EA	616-630	15.31 EA	50
50" riser with drop-ear elbow	32	20.37 EA	616-650	20.37 EA	25
30" riser x 8" stub out elbow	51	13.31 EA	608-L2308	13.31 EA	25
above riser with Square O Strap	52	14.31 EA	608-L2308E	14.31 EA	25
50" riser x 8" stub out elbow	53	19.19 EA	608-L2508	19.19 EA	25
above riser with Square O Strap	54	20.19 EA	608-L2508E	20.19 EA	25



D Power Bar Bracket

Description	KIT		BULK		
	Kit Code	Kit List Price	Bulk Item No.	Bulk List Price	Min./Case Qty.
Power Bar, 1 TD clamp, 4 screws	01	8.50 EA	523-2414	4.80 EA	50
Power Bar, 3 TD clamps, 4 screws			523-2434	6.00 EA	50
Power Bar, 6 screws	02	8.50 EA	523-2404	4.25 EA	50
Power Bar, 2 TD clamps, 4 screws			523-2424	5.25 EA	50
Power Bar, 6 screws	03	8.50 EA	523-2404	4.25 EA	50
Power Bar, 3 TD clamps, 4 screws			523-2434	6.00 EA	50
Power Bar, 1 TD clamp, 4 screws	04	8.50 EA	523-2414	4.80 EA	50
Power Bar, 2 TD clamps, 4 screws			523-2424	5.25 EA	50

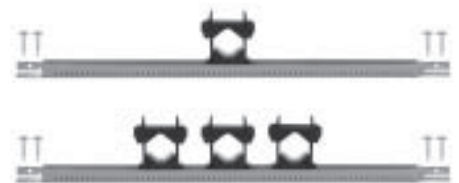

CPVC System MIP Connection

A Tub Spout Elbow

• ½" MIP swivel or fixed connection

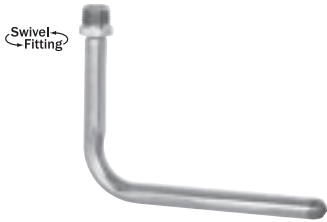

Description	KIT		BULK		
	Kit Code	Kit List Price	Bulk Item No.	Bulk List Price	Min./Case Qty.
None (for shower only)	01	—	—	—	—
5" x 7", swivel connection	02	7.23 EA	613-57X	7.23 EA	50
6" x 7", swivel connection	03	7.27 EA	613-67X	7.27 EA	50
8" x 7", swivel connection	04	8.18 EA	613-87X	8.18 EA	50
5½" x 7", fixed connection	05	6.37 EA	613-57M	6.37 EA	50
6½" x 7", fixed connection	06	6.58 EA	613-67M	6.58 EA	50
8½" x 7", fixed connection	07	7.09 EA	613-87M	7.09 EA	50

B Tub/Shower Pressure Connector



Description	KIT		BULK		
	Kit Code	Kit List Price	Bulk Item No.	Bulk List Price	Min./Case Qty.
½" CPVC x MIP adapter	01	8.52 EA	646-C2	4.26 EA	50
½" CPVC x MIP swivel, 6" x 3" elbow	02	15.16 EA	632-C263X	7.58 EA	50

C Shower Riser

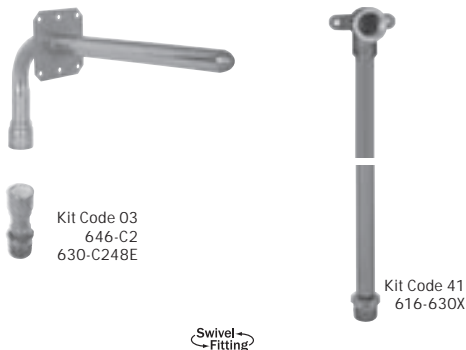

Description	KIT		BULK		
	Kit Code	Kit List Price	Bulk Item No.	Bulk List Price	Min./Case Qty.
FOR USE WITH CPVC RISER					
½" CPVC x MIP adapter	02	9.96 EA	646-C2	4.26 EA	50
½" CPVC, 3½" x 8" stub out elbow			630-C248	5.70 EA	50
½" CPVC x MIP adapter	03	10.96 EA	646-C2	4.26 EA	50
½" CPVC, 3½" x 8" Square O elbow			630-C248E	6.70 EA	25
½" CPVC x MIP adapter	04	11.14 EA	646-C2	4.26 EA	50
½" CPVC drop-ear elbow			647-C2E	6.88 EA	50
FULL LENGTH COPPER RISER					
½" MIP swivel, 30", with drop-ear elbow	41	19.10 EA	616-630X	19.10 EA	50
½" MIP swivel, 50", with drop-ear elbow	42	24.19 EA	616-650X	24.19 EA	25
½" MIP swivel, 30" x 8" stub out elbow above riser with Square O Strap	61	16.39 EA	608-L2308X	16.39 EA	25
½" MIP swivel, 50" x 8" stub out elbow above riser with Square O Strap	62	17.39 EA	608-L2308EX	17.39 EA	25
½" MIP swivel, 30" x 8" stub out elbow above riser with Square O Strap	63	22.48 EA	608-L2508X	22.48 EA	25
½" MIP swivel, 50" x 8" stub out elbow above riser with Square O Strap	64	23.48 EA	608-L2508EX	23.48 EA	25

D Power Bar Bracket

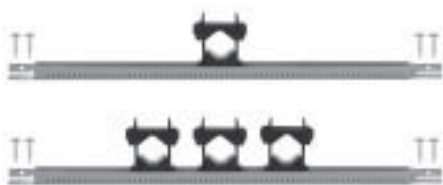

Description	KIT		BULK		
	Kit Code	Kit List Price	Bulk Item No.	Bulk List Price	Min./Case Qty.
Power Bar, 1 TD clamp, 4 screws	01	8.50 EA	523-2414	4.80 EA	50
Power Bar, 3 TD clamps, 4 screws			523-2434	6.00 EA	50
Power Bar, 6 screws	02	8.50 EA	523-2404	4.25 EA	50
Power Bar, 2 TD clamps, 4 screws			523-2424	5.25 EA	50
Power Bar, 6 screws	03	8.50 EA	523-2404	4.25 EA	50
Power Bar, 3 TD clamps, 4 screws			523-2434	6.00 EA	50
Power Bar, 1 TD clamp, 4 screws	04	8.50 EA	523-2414	4.80 EA	50
Power Bar, 2 TD clamps, 4 screws			523-2424	5.25 EA	50

CPVC System FIP Connection

A Tub Spout Elbow

- 1/2" FIP swivel connection

Description	KIT		BULK		
	Kit Code	Kit List Price	Bulk Item No.	Bulk List Price	Min./Case Qty.
None (for shower only)	01	—	—	—	—
5" x 7"	31	6.12 EA	613-57Y	6.12 EA	50
6" x 7"	32	6.15 EA	613-67Y	6.15 EA	50
8" x 7"	33	7.13 EA	613-87Y	7.13 EA	50



B Tub/Shower Pressure Connector

Description	KIT		BULK		
	Kit Code	Kit List Price	Bulk Item No.	Bulk List Price	Min./Case Qty.
1/2" FIP swivel x CPVC adapter	41	8.94 EA	637-C20	4.47 EA	25
1/2" FIP x CPVC adapter	42	9.64 EA	647-C2	4.82 EA	50
1/2" CPVC x FIP swivel, 6" x 3" elbow	43	12.72 EA	632-C263Y	6.36 EA	50
1/2" CPVC x FIP swivel, Mini-Rester tee	65	43.50 EA	660-TSV7	21.75 EA	25



C Shower Riser

Description	KIT		BULK		
	Kit Code	Kit List Price	Bulk Item No.	Bulk List Price	Min./Case Qty.
FOR USE WITH CPVC RISER					
1/2" CPVC x FIP swivel adapter	05	11.35 EA	637-C20	4.47 EA	25
1/2" CPVC drop-ear elbow			647-C2E	6.88 EA	50
1/2" CPVC x FIP swivel adapter	06	10.17 EA	637-C20	4.47 EA	25
1/2" CPVC, 3 1/2" x 8" stub out elbow			630-C248	5.70 EA	50
1/2" CPVC x FIP swivel adapter	07	11.17 EA	637-C20	4.47 EA	25
1/2" CPVC, 3 1/2" x 8" Square O elbow			630-C248E	6.70 EA	25
FULL LENGTH COPPER RISER					
1/2" FIP swivel, 30", with drop-ear elbow	43	17.82 EA	616-630Y	17.82 EA	50
1/2" FIP swivel, 50", with drop-ear elbow	44	22.90 EA	616-650Y	22.90 EA	25
1/2" FIP swivel, 30" x 8" Stub Out elbow	71	15.87 EA	608-L2308Y	15.87 EA	25
above riser with Square O Strap	72	16.87 EA	608-L2308EY	16.87 EA	25
1/2" FIP swivel, 50" x 8" Stub Out elbow	73	22.54 EA	608-L2508Y	22.54 EA	25
above riser with Square O Strap	74	23.54 EA	608-L2508EY	23.54 EA	25



D Power Bar Bracket

Description	KIT		BULK		
	Kit Code	Kit List Price	Bulk Item No.	Bulk List Price	Min./Case Qty.
Power Bar, 1 TD clamp, 4 screws	01	8.50 EA	523-2414	4.80 EA	50
Power Bar, 3 TD clamps, 4 screws			523-2434	6.00 EA	50
Power Bar, 6 screws	02	8.50 EA	523-2404	4.25 EA	50
Power Bar, 2 TD clamps, 4 screws			523-2424	5.25 EA	50
Power Bar, 6 screws	03	8.50 EA	523-2404	4.25 EA	50
Power Bar, 3 TD clamps, 4 screws			523-2434	6.00 EA	50
Power Bar, 1 TD clamp, 4 screws	04	8.50 EA	523-2414	4.80 EA	50
Power Bar, 2 TD clamps, 4 screws			523-2424	5.25 EA	50

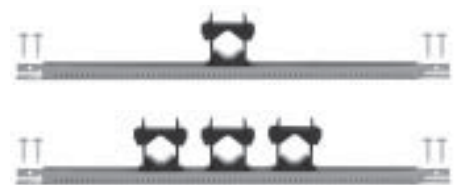

SUPPLY
DRAINAGE
SUPPORT
TESTING
SPECIALTIES
TOOLS
ACCESS

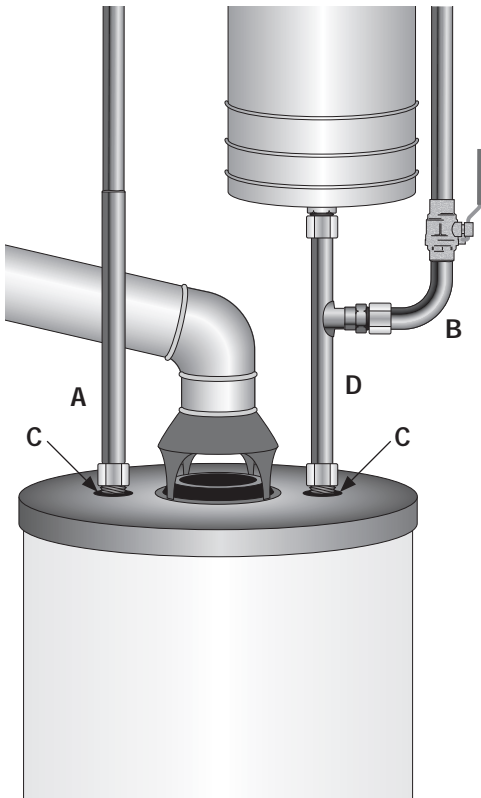

- A** Hot Side Connector
- B** Cold Side Connector
- C** Nipple Option
- D** Expansion Tank Option

Water Heater Connector Kits for Sweat

- Convenient kits are great for new construction and repair/remodel job sites
- Build your own pre-packaged water heater connector kit with the number system below
- Kits are individually bagged, shipped 10 to a box

Build Kit Item Numbers

Component	A Hot Side Connector	B Cold Side Connector	C Nipple Option	D Expansion Tank Option	Packaging Fee	Water Heater Connector Kit 694-A B C D
Kit Code	21	01	23	91		694-21 01 23 91
Description	straight 3/4" MIP swivel x 3/4" full-slip FSWT	elbow 3/4" FIP swivel x 3/4" FSWT, ball valve	two 3/4" MIP x 3/4" MIP	3/4" FIP swivel x 3/4" FIP swivel with 3/4" MIP branch		total price of components and packaging fee
Price	11.31	21.82	7.00	22.60	1.50	64.23 KT

Related Products
More detail on sweat water heater connectors p 20

Most Popular Kits

Item No.	Components	Min. Qty.	Case Qty.	List Price
694-211123	3/4" FIP swivel x 3/4" full-slip FSWT 3/4" FIP swivel x 3/4" full-slip FSWT, ball valve Two 3/4" MIP x 3/4" MIP dielectric nipples	10	10	44.79 KT
694-211120	3/4" FIP swivel x 3/4" full-slip FSWT 3/4" FIP swivel x 3/4" full-slip FSWT, ball valve	10	10	37.79 KT

Copper System

DO NOT use pipe dope on FIP threads

A Hot Side Connector

Description	Kit Code	Length	Item No.	List Price
3/4" FIP swivel x 3/4" full-slip FSWT	21	12"	633-312	11.31 EA
1" FIP swivel x 3/4" full-slip FSWT	22	12"	633-4312	17.77 EA
3/4" FIP swivel x 7/8" compression	23	12"	633-312C	18.23 EA
3/4" FIP swivel x 3/4" FSWT elbow	41	—	631-33F	7.04 EA
3/4" MIP x 3/4" full-slip FSWT	61	12"	646-312	12.28 EA
3/4" MIP x 7/8" compression	62	12"	646-312C	19.06 EA
3/4" FIP swivel x 1/2" full-slip FSWT	81	12"	633-212	7.34 EA



B Cold Side Connector

Description	Kit Code	Length	Item No.	List Price
3/4" FIP swivel x 3/4" FSWT elbow, ball valve	01	—	631-305FP	21.82 EA
3/4" FIP swivel x 3/4" full-slip FSWT, ball valve	11	12"	633-312FP	24.98 EA
1" FIP swivel x 3/4" full-slip FSWT, ball valve	12	12"	633-4312FP	34.14 EA
3/4" FIP swivel x 7/8" compression, ball valve	13	12"	633-312CFP	33.79 EA
3/4" MIP x 3/4" full-slip FSWT, ball valve	51	12"	646-312FP	26.58 EA
3/4" MIP x 7/8" compression, ball valve	52	12"	646-312CFP	35.57 EA
3/4" FIP swivel x 1/2" full-slip FSWT, ball valve	82	12"	633-212FP	16.87 EA

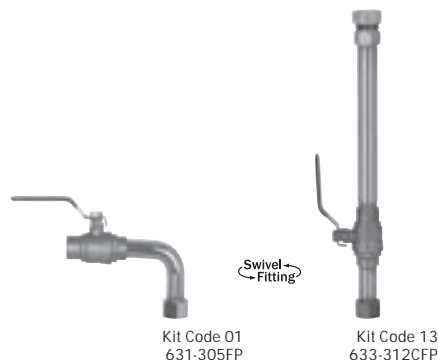

C Nipple Option

Description	Kit Code	Length	Item No.	List Price
No nipples	20	—	—	—
Two 3/4" MIP x 3/4" MIP	23	3"	635-33	7.00 PR
Two 1" MIP x 1" MIP	24	3"	635-43	14.90 PR

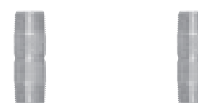

D Expansion Tank Option

Description	Kit Code	Length	Item No.	List Price
No expansion tank	—	—	—	—
3/4" x 3/4" FIP swivel with 3/4" MIP branch	91	15"	633-3TM15	22.60 EA
1" x 3/4" FIP swivel with 3/4" MIP branch	92	15"	633-4TM15	33.45 EA
3/4" x 3/4" FIP swivel with 3/4" MIP branch	93	11"	633-3TM11	20.32 EA
1" x 3/4" FIP swivel with 3/4" MIP branch	94	11"	633-4TM11	30.98 EA



SUPPLY
DRAINAGE
SUPPORT
TESTING
SPECIALTIES
TOOLS
ACCESS

SUPPLY
DRAINAGE
SUPPORT
TESTING
SPECIALTIES
TOOLS
ACCESS

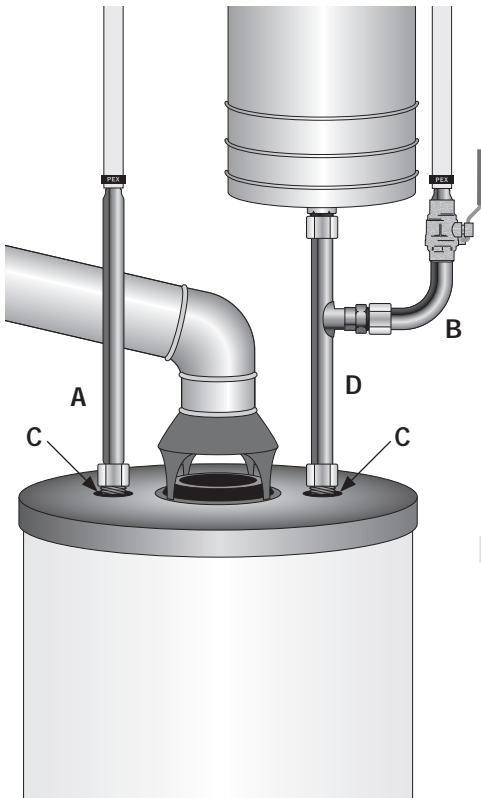

- A** Hot Side Connector
- B** Cold Side Connector
- C** Nipple Option
- D** Expansion Tank Option

Water Heater Connector Kits for PEX

- Convenient kits are great for new construction and repair/remodel job sites
- Build your own pre-packaged water heater connector kit with the number system below.
- Kits are individually bagged, shipped 10 to a box.

Build Kit Item Numbers

Component	A Hot Side Connector	B Cold Side Connector	C Nipple Option	D Expansion Tank Option	Packaging Fee	Water Heater Connector Kit 694X A B C D
Kit Code	32	01	23	91		694X 32 01 23 91
Description	straight ¾" FIP swivel × ¾" PEX	elbow ¾" FIP swivel × ¾" PEX, ball valve	two ¾" MIP × ¾" MIP	¾" FIP swivel × ¾" FIP swivel with ¾" MIP branch		total price of components and packaging fee
Price	13.90	22.48	7.00	22.60	1.50	67.48 KT

Related Products
More detail on PEX water heater connectors p 37

PEX System

DO NOT use pipe dope on FIP threads

A Hot Side Connection

Connection	Kit Code	Length	Item No.	List Price
3/4" PEX x 3/4" FIP swivel elbow	06	2 1/2" x 4 1/2"	631X02	6.11 EA
3/4" PEX x 3/4" FIP swivel elbow	07	6" x 6"	631X06	8.74 EA
3/4" PEX x 3/4" MIP, elbow	08	4" x 6"	631XM	9.82 EA
3/4" PEX x 3/4" FIP swivel s-bend	09	6" x 4 1/2"	631XS	7.80 EA
3/4" PEX x 3/4" FIP swivel	31	2"	633X02	4.85 EA
3/4" PEX x 3/4" FIP swivel	32	18"	633X18	13.90 EA
3/4" PEX x 1" FIP swivel	36	18"	633X418	21.10 EA
3/4" PEX x 3/4" FIP swivel flexible	46	18"	634X418	14.40 EA
3/4" PEX x 3/4" MIP	61	—	646X3	3.81 EA
3/4" PEX x 3/4" MIP	62	18"	646X318	15.04 EA

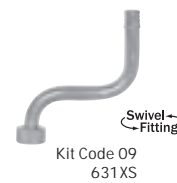

B Cold Side Connection

Connection	Kit Code	Length	Item No.	List Price
3/4" PEX x 3/4" FIP swivel elbow, ball valve	01	2 1/2" x 6"	631X02FP	22.48 EA
3/4" PEX x 3/4" FIP swivel, ball valve	21	18"	633X18FP	28.26 EA
3/4" PEX x 3/4" FIP swivel, ball valve with 3/4" FIP branch	25	18"	633X18FPT	41.31 EA
3/4" PEX x 3/4" FIP swivel flexible, ball valve	41	18"	634X418FP	27.82 EA
3/4" PEX x 3/4" MIP, ball valve	51	18"	646X318FP	28.51 EA
3/4" PEX x 1" FIP swivel, ball valve	71	18"	633X418FP	35.08 EA
3/4" PEX x 3/4" FIP swivel, ball valve with pressure relief 3/8" O.D. compression	22	18"	633X18FRV	68.52 EA



C Nipple Option

Description	Kit Code	Length	Item No.	List Price
No nipples	20	—	—	—
Two 3/4" MIP x 3/4" MIP	23	3"	635-33	7.00 PR
Two 1" MIP x 1" MIP	24	3"	635-43	14.90 PR



D Expansion Tank Option

Description	Kit Code	Length	Item No.	List Price
No expansion tank	—	—	—	—
3/4" x 3/4" FIP swivel with 3/4" MIP branch	91	15"	633-3TM15	22.60 EA
1" x 3/4" FIP swivel with 3/4" MIP branch	92	15"	633-4TM15	33.45 EA
3/4" x 3/4" FIP swivel with 3/4" MIP branch	93	11"	633-3TM11	20.32 EA
1" x 3/4" FIP swivel with 3/4" MIP branch	94	11"	633-4TM11	30.98 EA



SUPPLY

DRAINAGE

SUPPORT

TESTING

SPECIALTIES

TOOLS

ACCESS

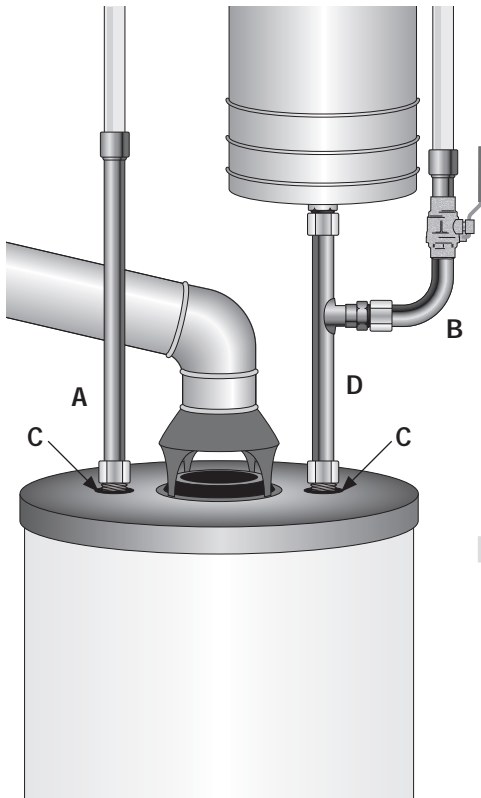

- A Hot Side Connector
- B Cold Side Connector
- C Nipple Option
- D Expansion Tank Option

Water Heater Connector Kits for CPVC

- Convenient kits are great for new construction and repair/remodel job sites
- Build your own pre-packaged water heater connector kit with the number system below.
- Kits are individually bagged, shipped 10 to a box.

Build Kit Item Numbers

Component	A Hot Side Connector	B Cold Side Connector	C Nipple Option	D Expansion Tank Option	Packaging Fee	Water Heater Connector Kit 694C A B C D
Kit Code	33	01	23	91		694C 33 01 23 91
Description	straight 3/4" FIP swivel x 3/4" CPVC	elbow 3/4" FIP swivel x 3/4" CPVC, ball valve	two 3/4" MIP x 3/4" MIP	3/4" FIP swivel x 3/4" FIP swivel with 3/4" MIP branch		total price of components and packaging fee
Price	15.06	26.65	7.00	22.60	1.50	72.81 KT

Related Products

More detail on CPVC water heater connectors

p 52

Most Popular Kits

Item No.	Components	Min. Qty.	Case Qty.	List Price
694C 33 01 20 91	3/4" FIP swivel x 3/4" CPVC socket 3/4" FIP swivel x 3/4" CPVC socket elbow, ball valve 3/4" x 3/4" FIP swivel with 3/4" MIP branch	10	10	65.81 KT
694C 33 12 20	3/4" FIP swivel x 3/4" CPVC socket 3/4" FIP swivel x 3/4" CPVC socket, ball valve	10	10	45.77 KT
694C 33 01 20 93	3/4" FIP swivel x 3/4" CPVC socket 3/4" FIP swivel x 3/4" CPVC socket elbow, ball valve 3/4" x 3/4" FIP swivel with 3/4" MIP branch	10	10	63.53 KT
694C 36 15 20	1" FIP swivel x 3/4" CPVC socket 1" FIP swivel x 3/4" CPVC socket, ball valve	10	10	62.71 KT
694C 36 01 20 92	1" FIP swivel x 3/4" CPVC socket 3/4" FIP swivel x 3/4" CPVC socket elbow, ball valve 1" x 3/4" FIP swivel with 3/4" MIP branch	10	10	85.41 KT
694C 36 01 20 94	1" FIP swivel x 3/4" CPVC socket 3/4" FIP swivel x 3/4" CPVC socket elbow, ball valve 1" x 3/4" FIP swivel with 3/4" MIP branch	10	10	82.94 KT
694C 33 01 23 91	3/4" FIP swivel x 3/4" CPVC socket 3/4" FIP swivel x 3/4" CPVC socket elbow, ball valve Two 3/4" MIP x 3/4" MIP dielectric nipples 3/4" x 3/4" FIP swivel with 3/4" MIP branch	10	10	72.81 KT

CPVC System

A Hot Side Connector

Connection	Kit Code	Length	Item No.	List Price
3/4" FIP swivel x 3/4" CPVC socket elbow	06	3" x 7"	631-C307	12.06 EA
3/4" FIP swivel x 3/4" CPVC socket	31	3"	633-C02	6.23 EA
3/4" FIP swivel x 3/4" CPVC socket	32	9"	633-C09	10.79 EA
3/4" FIP swivel x 3/4" CPVC socket	33	18"	633-C18	15.06 EA
3/4" FIP swivel x 3/4" CPVC socket, with 3/4" MIP branch	34	18"	633-C18M3	24.83 EA
3/4" FIP swivel x 3/4" CPVC socket	35	24"	633-C24	18.37 EA
1" FIP swivel x 3/4" CPVC socket	36	18"	633-C418	23.81 EA
1" FIP swivel x 3/4" CPVC socket	37	24"	633-C424	27.75 EA
3/4" FIP swivel x 3/4" CPVC socket flexible	56	18"	634-C118	17.71 EA
3/4" MIP x 3/4" CPVC socket	71	3 1/4"	646-C3	5.56 EA
3/4" MIP x 3/4" CPVC socket	72	18"	646-C318	15.20 EA
3/4" MIP x 3/4" CPVC socket	73	24"	646-C324	19.26 EA
1" MIP x 3/4" CPVC socket	74	18"	646-C3418	19.38 EA
1" MIP x 3/4" CPVC socket	75	24"	646-C3424	23.80 EA

DO NOT use pipe dope on FIP threads



Kit Code 06
631-C307

Swivel Fitting



Kit Code 56
634-C118

B Cold Side Connector

Connection	Kit Code	Length	Item No.	List Price
3/4" FIP swivel x 3/4" CPVC socket elbow, ball valve	01	3" x 7"	631-C307FP	26.65 EA
3/4" FIP swivel x 3/4" CPVC socket, ball valve	11	9"	633-C09FP	24.87 EA
3/4" FIP swivel x 3/4" CPVC socket, ball valve	12	18"	633-C18FP	29.21 EA
3/4" FIP swivel x 3/4" CPVC socket, ball valve, with 3/4" MIP branch	13	18"	633-C18FPM3	39.31 EA
3/4" FIP swivel x 3/4" CPVC socket, ball valve	14	24"	633-C24FP	32.32 EA
1" FIP swivel x 3/4" CPVC socket, ball valve	15	18"	633-C418FP	37.40 EA
1" FIP swivel x 3/4" CPVC socket, ball valve	16	24"	633-C424FP	40.41 EA
3/4" FIP swivel x 3/4" CPVC socket, ball valve with pressure relief 3/8" O.D. compression	17	18"	633-C18FRV	69.82 EA
3/4" FIP swivel x 3/4" CPVC socket, ball valve, with 3/4" FIP branch	21	18"	633-C18FPT	43.34 EA
3/4" FIP swivel x 3/4" CPVC socket, ball valve, with 3/4" FIP branch	22	24"	633-C24FPT	46.47 EA
1" FIP swivel x 3/4" CPVC socket, ball valve with pressure relief 3/8" O.D. compression	25	18"	633-C418FRV	73.39 EA
3/4" FIP swivel x 3/4" CPVC socket flexible, ball valve	51	18"	634-C118FP	30.77 EA
3/4" MIP x 3/4" CPVC socket, ball valve	61	18"	646-C318FP	28.76 EA
3/4" MIP x 3/4" CPVC socket, ball valve	63	24"	646-C324FP	31.85 EA
1" MIP x 3/4" CPVC socket, ball valve	64	18"	646-C3418FP	33.05 EA
1" MIP x 3/4" CPVC socket, ball valve	65	24"	646-C3424FP	35.91 EA
3/4" MIP x 3/4" CPVC socket, ball valve, with 3/4" FIP branch	81	18"	646-C318FPT	43.27 EA
3/4" MIP x 3/4" CPVC socket, ball valve, with 3/4" FIP branch	82	24"	646-C324FPT	46.54 EA



Kit Code 21
631-C18FPT

Swivel Fitting



Kit Code 61
646-C318FP

C Nipple Option

Description	Kit Code	Length	Item No.	List Price
No nipples	20	—	—	—
Two 3/4" MIP x 3/4" MIP	23	3"	635-33	7.00 PR
Two 1" MIP x 1" MIP	24	3"	635-43	14.90 PR



D Expansion Tank Option

Description	Kit Code	Length	Item No.	List Price
No expansion tank	—	—	—	—
3/4" x 3/4" FIP swivel with 3/4" MIP branch	91	15"	633-3TM15	22.60 EA
1" x 3/4" FIP swivel with 3/4" MIP branch	92	15"	633-4TM15	33.45 EA
3/4" x 3/4" FIP swivel with 3/4" MIP branch	93	11"	633-3TM11	20.32 EA
1" x 3/4" FIP swivel with 3/4" MIP branch	94	11"	633-4TM11	30.98 EA



Swivel Fitting

SUPPLY

DRAINAGE

SUPPORT

TESTING

SPECIALTIES

TOOLS

ACCESS

Kits

SUPPLY

DRAINAGE



DO NOT use pipe dope on FIP threads

Tankless Water Heater Connector Kit

Sweat & FIP Connections

- Fits most tankless water heaters
- 3/4" full port ball valves
- Integrated all brass tee for pressure valve
- 1/4-turn drain valves for drainage/flushing
- Pressure valve and installation instructions included

Item No.	Connection	Min. Qty	Case Qty	List Price
690-0101	3/4" FIP swivel x 3/4" sweat	1	1	101.82 EA
690-2020	3/4" FIP swivel x 3/4" FIP	1	1	109.35 EA

SUPPORT

Heating Coil Loop Kit

Supply and Return Loop Connectors

- For use with high recovery hydronic systems. Preformed supply and return loop connectors provide easy installation

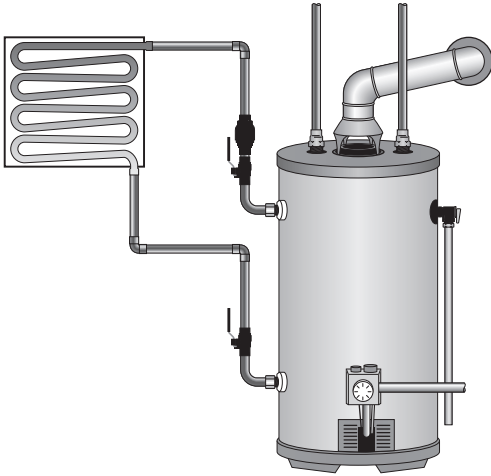

TESTING

Sweat System

Component	Supply Loop Elbow	Return Loop Elbow	Dielectric Connector
Standard Kit	3/4" FIP swivel x 3/4" FSWT, full port ball valve	3/4" FIP swivel x 3/4" FSWT, full port ball valve	Two 3/4" MIP x 3/4" MIP, 3" long
Check Valve Kit	3/4" FIP swivel x 3/4" FSWT, full port ball valve, with spring-loaded check valve	3/4" FIP swivel x 3/4" FSWT, full port ball valve	Two 3/4" MIP x 3/4" MIP, 3" long

SPECIALTIES

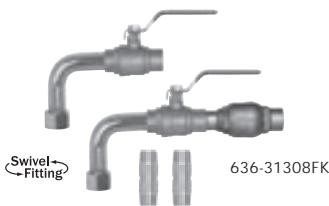

636-31308FK

CPVC System

Component	Supply Loop Elbow	Return Loop Elbow	Dielectric Connector	Boiler Drain	MIP Adapter
Standard Kit	3/4" FIP swivel x 3/4" CPVC, full port ball valve	3/4" FIP swivel x 3/4" CPVC, full port ball valve	Two 3/4" MIP x 3/4" MIP, 3" long	1/2" CPVC boiler drain	1/2" CPVC x 1/2" MIP adapter
Check Valve Kit	3/4" FIP swivel x 3/4" CPVC, full port ball valve, with spring-loaded check valve	3/4" FIP swivel x 3/4" CPVC, full port ball valve	Two 3/4" MIP x 3/4" MIP, 3" long	1/2" CPVC boiler drain	1/2" CPVC x 1/2" MIP adapter

TOOLS

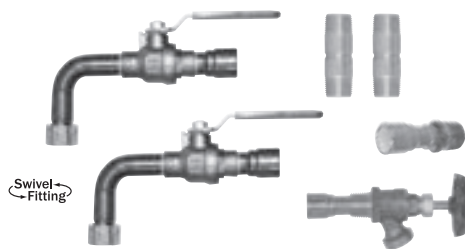

636-C1307F2

DO NOT use pipe dope on FIP threads

ACCESS

Item No.	Description	Min. Qty	Case Qty	List Price
SWEAT				
636-31305F	Standard heating coil loop kit	10	10	53.21 KT
636-31308FK	Check valve heating coil loop kit	10	10	99.68 KT
CVPC				
636-C1307F2	Standard heating coil loop kit	10	10	77.45 KT
636-C1310FK2	Check valve heating coil loop kit	10	10	120.73 KT

Manifolds

Potable Water
Hydronic Heating

SUPPLY

DRAINAGE

SUPPORT

TESTING

SPECIALTIES

TOOLS

ACCESS



SUPPLY

DRAINAGE

SUPPORT

TESTING

SPECIALTIES

TOOLS

ACCESS

BranchMaster™ Copper Manifolds

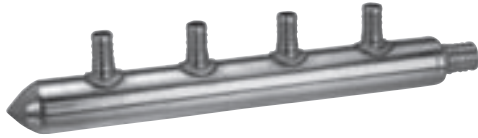

- Continuous runs of PEX piping without joints
- Cuts installation time
- Equalized flow to each fixture helps reduce pressure fluctuations which cause scalding
- Great for primary or secondary manifolding
- PEX branches have lead-free solder joints
- Sweat branches are brazed to trunk for safe soldering
- Lifetime guaranteed
- Manifolds with valved branches require access panels. Those without valves do not require access panels

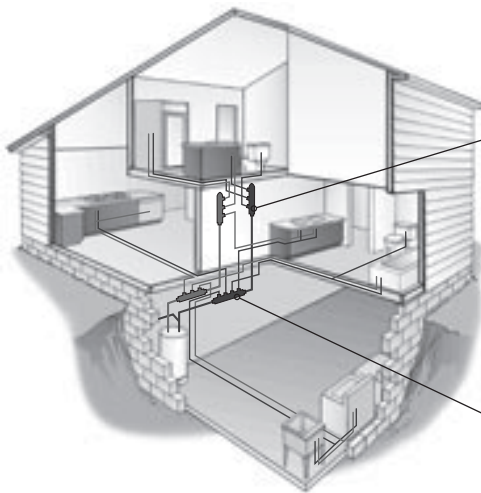

Secondary Manifold

Primary Manifold

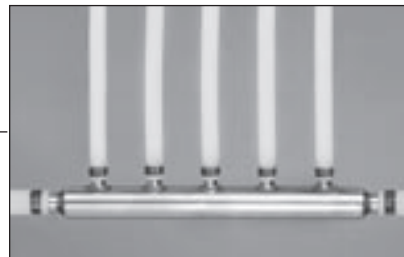

BranchMaster™ Custom Copper Manifolds



Branch Options

- 3/8", 1/2", and 3/4" PEX
- 1/2", 3/4", and 1" male sweat
- 1/2", 3/4", and 1" female sweat
- 1/2", 3/4", and 1" MIP
- 1/2", 3/4", and 1" FIP

Optional distance between branch center

Mini-ball or full port ball valves

Trunk Options

- 3/4" CTS Type L
- 1" CTS Type L
- 1 1/4" CTS Type L
- 1 1/2" CTS Type L
- 2" CTS Type L

Trunk End Options

- 3/4" and 1" PEX
- 3/4", 1", 1 1/4", 1 1/2", and 2" male sweat
- 3/4", 1", and 1 1/4" female sweat
- 3/4", 1", 1 1/4", 1 1/2", and 2" MIP
- 3/4", 1", 1 1/4", 1 1/2", and 2" FIP
- 3/4", 1", 1 1/4", 1 1/2", and 2" spin closed
- Extended trunk ends
- Full port ball valve

All custom manifolds have a minimum quantity of 25. Custom made parts are not normal stock, and cannot be returned, except in cases of manufacturer's defect.

3/8" PEX Branches

Sweat Trunk
PEX Trunk

- 1" Type L trunk
- Branches are 2" on-center

Item No.	Branch Qty.	Trunk Ends	Min. Qty.	Case Qty.	List Price
671X0430	4	3/4" male sweat × spin closed	25	25	19.45 EA
671X0630	6	3/4" male sweat × spin closed	25	25	25.22 EA
671X0830	8	3/4" male sweat × spin closed	25	25	31.32 EA
671X1030	10	3/4" male sweat × spin closed	25	25	38.05 EA
671X1230	12	3/4" male sweat × spin closed	25	25	46.33 EA
671X0490	4	3/4" PEX × spin closed	25	25	18.42 EA
671X0690	6	3/4" PEX × spin closed	25	25	24.71 EA
671X0890	8	3/4" PEX × spin closed	25	25	30.91 EA
671X1090	10	3/4" PEX × spin closed	25	25	37.25 EA
671X1290	12	3/4" PEX × spin closed	25	25	47.60 EA

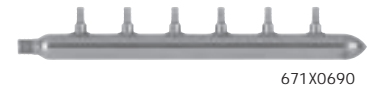

1/2" PEX Ball Valve Branches

Sweat Trunk
PEX Trunk

- 3/4" or 1" Type L trunk
- Branches are 2" on-center (except when noted)



Item No.	Branch Qty.	Trunk Ends	Min. Qty.	Case Qty.	List Price
BULK					
672XV0810	8	1" female sweat × spin closed	1	10	105.73 EA
672XV1010	10	1" female sweat × spin closed	1	10	132.98 EA
672XV1210	12	1" female sweat × spin closed	5	5	160.86 EA
672XV1510	15	1" female sweat × spin closed	5	5	202.19 EA
672XV1810	18	1" female sweat × spin closed	5	5	255.30 EA
672XV4L-11313	11	1" male sweat × 1" female sweat, branches 3" O.C.	5	5	193.08 EA
672XV0490	4	3/4" PEX × spin closed	1	10	57.53 EA
672XV0590	5	3/4" PEX × spin closed	1	10	70.55 EA
672XV0690	6	3/4" PEX × spin closed	1	10	84.60 EA
672XV0499	4	3/4" PEX × 3/4" PEX	1	10	58.75 EA
672XV0599	5	3/4" PEX × 3/4" PEX	1	10	71.87 EA
672XV0699	6	3/4" PEX × 3/4" PEX	1	10	86.37 EA
INDIVIDUALLY BAR-CODED IN A CUT CASE BOX					
672XV3L-0431PK	4	3/4" male sweat × 3/4" female sweat, 3/4" Type L trunk	5	5	62.11 EA
672XV0431PK	4	1" male sweat × 1" female sweat	5	5	63.78 EA
672XV0699-2PK	6	3/4" PEX × 3/4" PEX	5	5	98.70 EA

1/2" PEX Branches

Sweat Trunk

PEX Trunk

- 1" Type L trunk
- Branches are 2" on-center



672X0699

Extended Length Trunk Ends

- Extended ends can be easily converted to 1" male sweat by cutting off the reduction or spin closed end



672X0433EE

Item No.	Branch Qty.	Trunk Ends	Min. Qty.	Case Qty.	List Price
NORMAL TRUNK ENDS					
BULK					
672X0430	4	3/4" male sweat x spin closed	25	25	17.07 EA
672X0630	6	3/4" male sweat x spin closed	25	25	23.08 EA
672X0830	8	3/4" male sweat x spin closed	25	25	28.45 EA
672X0930	9	3/4" male sweat x spin closed	25	25	30.86 EA
672X1230	12	3/4" male sweat x spin closed	25	25	39.99 EA
672X1240	12	1" male sweat x spin closed	25	25	39.38 EA
672X4L-1131B3	11	1" female sweat x 1" male sweat	5	5	84.48 EA
672X0390	3	3/4" PEX x spin closed	25	25	14.03 EA
672X0490	4	3/4" PEX x spin closed	25	25	16.87 EA
672X0590	5	3/4" PEX x spin closed	25	25	20.35 EA
672X0690	6	3/4" PEX x spin closed	25	25	22.71 EA
672X0790	7	3/4" PEX x spin closed	25	25	25.25 EA
672X0890	8	3/4" PEX x spin closed	25	25	27.78 EA
672X0990	9	3/4" PEX x spin closed	25	25	29.92 EA
672X1090	10	3/4" PEX x spin closed	25	25	32.30 EA
672X1290	12	3/4" PEX x spin closed	25	25	40.70 EA
672X0399	3	3/4" PEX x 3/4" PEX	25	25	14.24 EA
672X0499	4	3/4" PEX x 3/4" PEX	25	25	17.51 EA
672X0599	5	3/4" PEX x 3/4" PEX	25	25	20.91 EA
672X0699	6	3/4" PEX x 3/4" PEX	25	25	23.34 EA
672X0899	8	3/4" PEX x 3/4" PEX	25	25	29.27 EA
672X0999	9	3/4" PEX x 3/4" PEX	25	25	31.93 EA
672X1299	12	3/4" PEX x 3/4" PEX	25	25	41.45 EA
INDIVIDUALLY BAR-CODED IN A CUT CASE BOX					
672X0431PK	4	3/4" female sweat x 3/4" male sweat	5	5	24.10 EA
672X0441PK	4	1" female sweat x 1" male sweat	5	5	24.67 EA
672X0699PK	6	3/4" PEX x 3/4" PEX	5	5	24.60 EA
EXTENDED LENGTH TRUNK ENDS					
BULK					
672X0433EE	4	3/4" male sweat, extended	10	10	25.78 EA
672X0633EE	6	3/4" male sweat, extended	10	10	31.10 EA
672X0833EE	8	3/4" male sweat, extended	10	10	37.25 EA
672X1033EE	10	3/4" male sweat, extended	10	10	45.10 EA
672X1233EE	12	3/4" male sweat, extended	10	10	51.24 EA
672X0490EE	4	3/4" PEX, extended x spin closed	10	10	26.00 EA
672X0690EE	6	3/4" PEX, extended x spin closed	10	10	28.21 EA

Mixed PEX Branches

PEX Trunk

- 1" Type L trunk
- Branches are 2" on-center



Item No.	3/4" Branch Qty.	1/2" Branch Qty.	Trunk Ends	Min. Qty.	Case Qty.	List Price
679X152190	5	1	3/4" PEX x spin closed	10	10	24.48 EA
679X152199	5	1	3/4" PEX x 3/4" PEX	10	10	25.38 EA
679X172199	7	1	3/4" PEX x 3/4" PEX	10	10	32.64 EA
679X102299	10	2	3/4" PEX x 3/4" PEX	10	10	45.64 EA

Male Sweat Branches

- 1" Type L trunk (except when noted)
- Branches are brazed to trunk
- Branches are 2" on-center (except when noted)



678-21244

Item No.	Branch Qty.	Trunk Ends	Min. Qty.	Case Qty.	List Price
1/2" MALE SWEAT BRANCH					
678-20344	3	1" male sweat x 1" male sweat	10	10	16.82 EA
678-20644	6	1" male sweat x 1" male sweat	10	10	29.97 EA
678-21244	12	1" male sweat x 1" male sweat	10	10	56.02 EA
678-20242	2	1" male sweat x 1" female sweat	10	10	13.05 EA
678-20342	3	1" male sweat x 1" female sweat	10	10	16.91 EA
678-20442	4	1" male sweat x 1" female sweat	10	10	21.30 EA
6784L-11313	11	1" male sweat x 1" female sweat, branches 3" O.C.	5	5	63.95 EA
3/4" MALE SWEAT BRANCH					
6795L-12333	12	1 1/4" male sweat x 1 1/4" male sweat, 1 1/4" Type L trunk, branches 3" O.C.	5	5	110.42 EA
6796L-12333	12	1 1/2" male sweat x 1 1/2" male sweat, 1 1/2" Type L trunk, branches 3" O.C.	5	5	122.95 EA
6797L-12333	12	2" male sweat x 2" male sweat, 2" Type L trunk, branches 3" O.C.	5	5	156.32 EA



678-4L11313

3/4" Female Sweat Branches

- 1 1/4" Type L trunk
- Branches are 4" on-center
- Branches extend 4" from trunk



Item No.	Branch Qty.	Trunk Ends	Min. Qty.	Case Qty.	List Price
67745L-08334	8	1 1/4" male sweat x 1 1/4" male sweat	5	5	92.74 EA

½" MIP/Female Sweat Ball Valve Branches

- 1" Type L trunk
- Branches are 2" on-center



Item No.	Branch Qty.	Trunk Ends	Min. Qty.	Case Qty.	List Price
675-V20244	2	1" male sweat × 1" male sweat	1	10	35.50 EA
675-V20344	3	1" male sweat × 1" male sweat	1	10	48.74 EA
675-V20444	4	1" male sweat × 1" male sweat	1	10	62.24 EA
675-V20544	5	1" male sweat × 1" male sweat	1	10	76.09 EA

½" MIP Branches

- 1" Type L trunk
- Branches are 2" on-center



Item No.	Branch Qty.	Trunk Ends	Min. Qty.	Case Qty.	List Price
675-20244	2	1" male sweat × 1" male sweat	10	10	20.63 EA
675-20344	3	1" male sweat × 1" male sweat	10	10	26.62 EA
675-20444	4	1" male sweat × 1" male sweat	10	10	33.80 EA
675-20544	5	1" male sweat × 1" male sweat	10	10	41.72 EA

BranchMaster™ Copper Manifolds for Hydronic Applications

- Most branch connections available with and without ball valves or balancing valves
- Easy to connect multiple manifolds using standard 1" female sweat × 1" male sweat trunks

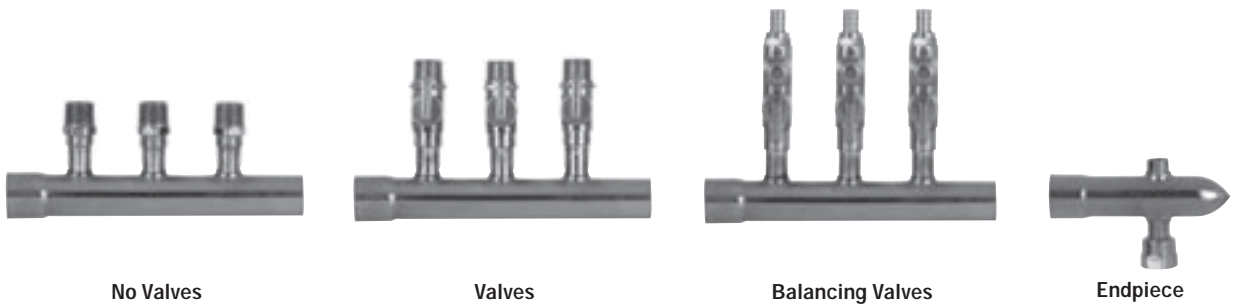

No Valves

Valves

Balancing Valves

Endpiece

½" Male Sweat Branches

- 1" Type L trunk with 1" FSWT × 1" MSWT connection
- Branches are 2" on-center



Item No.	Branch Qty	Min Qty.	Case Qty.	List Price
NO VALVES				
678-20242	2	10	10	13.05 EA
678-20342	3	10	10	16.91 EA
678-20442	4	10	10	21.30 EA

1/2" MIP Branches

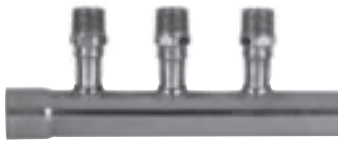

- 1" Type L trunk with 1" FSWT x 1" MSWT connection
- Branches are 2" on-center

Item No.	Branch Qty	Min Qty.	Case Qty.	List Price
NO VALVES				
675-20242	2	1	10	20.73 EA
675-20342	3	1	10	26.72 EA
675-20442	4	1	10	33.90 EA

1/2" MIP/Female Sweat Branches

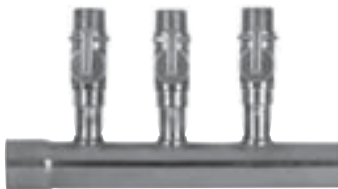

- 1" Type L trunk with 1" FSWT x 1" MSWT connection
- Branches are 2" on-center

Item No.	Branch Qty	Min Qty.	Case Qty.	List Price
VALVES				
675-V20242	2	1	10	35.60 EA
675-V20342	3	1	10	48.84 EA
675-V20442	4	1	10	62.24 EA
BALANCING VALVES				
675-B20242	2	1	10	64.52 EA
675-B20342	3	1	10	92.37 EA
675-B20442	4	1	10	117.30 EA

1/2" PEX F1807 Branches

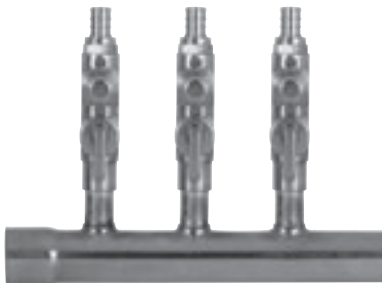

- 1" Type L trunk with 1" FSWT x 1" MSWT connection
- Branches are 2" on-center

Item No.	Branch Qty	Min Qty.	Case Qty.	List Price
NO VALVES				
672X0242	2	1	10	16.84 EA
672X0342	3	1	10	21.09 EA
672X0442	4	1	10	25.18 EA
VALVES				
672XV0242	2	1	10	31.89 EA
672XV0342	3	1	10	43.67 EA
672XV0442	4	1	10	55.46 EA
BALANCING VALVES				
672XB0242	2	1	10	63.71 EA
672XB0342	3	1	10	91.22 EA
672XB0442	4	1	10	115.83 EA

1/2" ComPEX Branches

- 1" Type L trunk with 1" FSWT x 1" MSWT connection
- Branches are 2" on-center
- 1/2" ComPEX 5/8" O.D. compression branches

Item No.	Branch Qty	Min Qty.	Case Qty.	List Price
NO VALVES				
672C0242	2	1	10	35.29 EA
672C0342	3	1	10	48.76 EA
672C0442	4	1	10	62.17 EA
VALVES				
672CV0242	2	1	10	43.16 EA
672CV0342	3	1	10	61.80 EA
672CV0442	4	1	10	78.47 EA
BALANCING VALVES				
672CB0242	2	1	10	72.81 EA
672CB0342	3	1	10	104.26 EA
672CB0442	4	1	10	132.39 EA

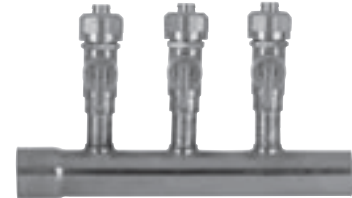

1/2" R20 Branches

- 1" Type L trunk with 1" FSWT x 1" MSWT connection
- Branches are 2" on-center
- R20 is a 20 mm Euroconical threaded connection

Item No.	Branch Qty	Min Qty.	Case Qty.	List Price
NO VALVES				
672R0242	2	1	10	28.60 EA
672R0342	3	1	10	38.72 EA
672R0442	4	1	10	48.78 EA
VALVES				
672RV0242	2	1	10	42.27 EA
672RV0342	3	1	10	60.52 EA
672RV0442	4	1	10	76.85 EA
BALANCING VALVES				
672RB0242	2	1	10	69.43 EA
672RB0342	3	1	10	99.41 EA
672RB0442	4	1	10	126.23 EA

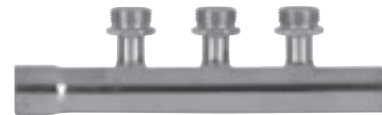

Manifold Endpiece

- 1" Type L trunk
- 1/8" FIP and 1/2" FIP branches



Item No.	Branch Qty	Trunk Ends	Min Qty.	Case Qty.	List Price
677-11	2	1" female sweat x spin closed	1	10	23.72 EA

Arresters & Primers

Water Hammer Arresters
Trap Primers

SUPPLY

DRAINAGE

SUPPORT

TESTING

SPECIALTIES

TOOLS

ACCESS



Residential Installation Guide

SUPPLY
DRAINAGE
SUPPORT
TESTING
SPECIALTIES
TOOLS
ACCESS

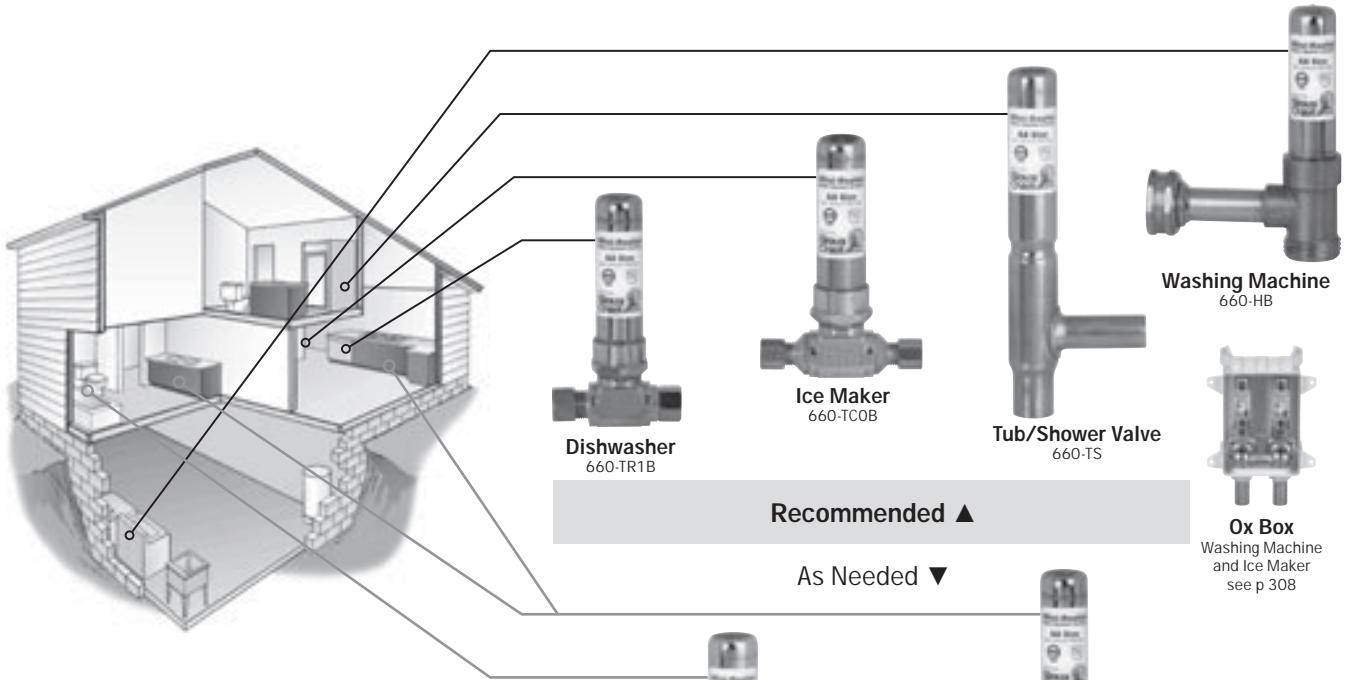

Specifications

Maximum Working Temp	250° F
Maximum Working Pressure for Pressure Testing	350 PSIG
Burst Tested	2,900 PSIG
Fixture Unit Value	4

In 1997, both IAPMO and ICC incorporated mandatory Water Hammer Control requirements into their national model codes, UPC and IPC/IRC. Since that time, many states have adopted these codes and are now fully enforcing the Water Hammer Control section for all segments of plumbing construction, especially residential. The AA size Mini-Rester was designed specifically for residential fixtures, and has made these code requirements feasible, affordable, easily inspected, and enforced. Sioux Chief recommends ASSE certified AA size arresters (Mini-Resters) installed at the very least on supply lines (both hot and cold) for washing machines, dishwashers, ice makers, and tub/shower valves to satisfy the minimum requirements of these codes. Arresters should be installed within six feet of the valve. All Sioux Chief Mini-Resters are AA size, regardless of connection size, and therefore are all equal in arrester capacity. Certain connection models may be intended for specific fixture applications, but other AA Mini-Rester models will control hammer on the same fixture just as well.

For High-Flow Garden Tub Valves and Multi-Head Shower Valves: Install 653-B Hydra-Resters (p 120) on both hot and cold supply lines within six feet of the valve.

For Lawn Irrigation Zone Valves: On ¾" service line, install one 653-B Hydra-Rester within six feet of each valve or group of valves. On 1" service line: Install one 654-C Hydra-Rester (p 120) within six feet of each valve or group of valves.



Toilet Ballcock
660-TKB



Lav/Sink Supply
660-TR1B

Mini-Rester™
Residential Water Hammer Arrester



- All Mini-Resters are approved for sealed wall installations with no access panel required
- Certified by ASSE to the ANSI/ASSE 1010-2004 Standard*
- May be installed at any angle

2006 Uniform Plumbing Code (UPC/IAPMO)

609.10 Water Hammer: All building water supply systems in which quick-acting valves are installed shall be provided with devices to absorb the hammer caused by high pressures resulting from the quick closing of these valves. These pressure-absorbing devices shall be approved mechanical devices. Water pressure-absorbing devices shall be installed as close as possible to quick-acting valves.

609.10.1 Mechanical Devices: When listed mechanical devices are used, the manufacturers' specifications as to location and method of installation shall be followed.

2006 International Plumbing Code (IPC)

604.9 Water hammer: The flow velocity of the water distribution system shall be controlled to reduce the possibility of water hammer. A water-hammer arrester shall be installed where quick-closing valves are utilized. Water-hammer arrestors shall be installed in accordance with the manufacturer's specifications. Water-hammer arrestors shall conform to ASSE 1010.

*Except: 660-C, 660-CB, 660-3SB, & 660-TS series



Mini-Rester™ Residential Water Hammer Arrester

Straight

- Straight sweat arresters are compatible with press-fit fitting systems, such as Ridgid-Viega ProPress and all push-fit fitting systems such as Cash Acme SharkBite
- Straight compression arresters install on any 1/2" nom. copper leg or riser. Especially popular in retrofitting 1/2" nom. air chambers
- MIP thread arresters install on any new rough-in or retrofit installation with 1/2" FIP fittings
- CPVC solvent weld arresters install on 1/2" CPVC tube in rough-in or retrofit applications

Tee

- Full slip tee sweats in-line on 1/2" CTS near problem valve or fixture
- Hose tee arresters install on washing machine supply valves or directly to washing machine

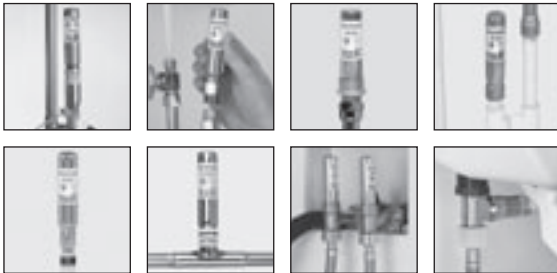

Item No.	Description	Min. Qty.	Case Qty.	List Price
STRAIGHT				
BULK				
660-SB	1/2" male sweat	50	50	12.25 EA
660-3SB	3/4" male sweat	50	50	16.25 EA
660-CB	5/8" O.D. compression straight	50	50	15.10 EA
660-2B	1/2" MIP thread	50	50	12.80 EA
660-V2B	1/2" CPVC socket	50	50	14.90 EA
660-X2B	1/2" PEX crimp straight	50	50	12.95 EA
BAR-CODED CLAMSHELLS IN A CUT CASE BOX				
660-S	1/2" male sweat	6	6	13.75 EA
660-C	5/8" O.D. compression straight	6	6	16.60 EA
660-2	1/2" MIP thread	6	6	14.30 EA
660-V2	1/2" CPVC socket	6	6	16.40 EA
TEE				
BULK				
660-T22	1/2" full-slip female sweat tee	25	25	15.50 EA
660-HB	3/4" female swivel hose thread x 3/4" male hose thread tee	25	25	15.65 EA
660-TKB	Female swivel ballcock nut x male ballcock thread tee	25	25	19.95 EA
BAR-CODED CLAMSHELLS IN A CUT CASE BOX				
660-H	3/4" female swivel hose thread x 3/4" male hose thread tee	6	6	17.15 EA
660-TK	Female swivel ballcock nut x male ballcock thread tee	6	6	21.45 EA

 Male sweat model only





660-SB



660-CB



660-2B



660-V2B



660-X2B



660-T22



660-HB



660-TKB

SUPPLY

DRAINAGE

SUPPORT

TESTING

SPECIALTIES

TOOLS

ACCESS

SUPPLY

DRAINAGE

SUPPORT

TESTING

SPECIALTIES

TOOLS

ACCESS

Mini-Rester™ Residential Water Hammer Arrester

Tub/Shower Tee

- Sweat branch arresters install easily on sweat tub/shower valves
- FIP swivel thread arresters install on MIP tub/shower valves. No more heat damaged cartridges from soldering valve

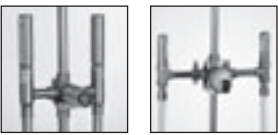

Item No.	Description	Min. Qty.	Case Qty.	List Price
TUB/SHOWER VALVE				
660-TS	1/2" male sweat open end branch x 1/2" female sweat tee	25	25	18.50 EA
NEW 660-TSF7	1/2" FIP swivel x 1/2" female sweat tee	25	25	21.25 EA
NEW 660-TSV7	1/2" FIP swivel x 1/2" CPVC tee	25	25	21.75 EA
NEW 660-TSX7	1/2" FIP swivel x 1/2" PEX F1807 crimp tee	25	25	20.75 EA
NEW 660-TSX	1/2" male sweat x 1/2" PEX F1807 crimp tee	25	25	22.50 EA

Male sweat model only 

Mini-Rester™ Residential Water Hammer Arrester

PEX Tee

- Great for in-line PEX installation for quick closing faucets
- PEX crimp fitting conforms to ASTM F-1807
- F2080 PEX fitting conforms to Wirsbo APR and Rehau Everloc

Compression Tee

- Install in-line on ice maker lines, lav or dishwasher supply tubes

Female Compression Tee

- Installs either between stub out and supply stop, or between supply stop and supply tube for faucets, dishwashers, toilets or ice makers



660-TW2



660-TX2B



660-TA2B



660-TB



660-TRB

NEW

Item No.	Description	Min. Qty.	Case Qty.	List Price
PEX TEE				
BULK				
660-TW2	½" Wirsbo ProPEX tee F1960	25	25	17.95 EA
660-TX1B	¾" PEX crimp tee F1807	25	25	17.25 EA
660-TX2B	½" PEX crimp tee F1807	25	25	15.95 EA
660-TA2B	½" PEX cold expansion tee F2080	25	25	18.95 EA
BAR-CODED CLAMSHELLS IN A CUT CASE BOX				
660-TX1	¾" PEX crimp tee F1807	6	6	18.75 EA
660-TX2	½" PEX crimp tee F1807	6	6	17.45 EA
COMPRESSION TEE				
BULK				
660-TC0B	¼" O.D. compression tee for ice maker tube	25	25	17.25 EA
660-TC1B	¾" O.D. compression tee for supply tube	25	25	17.75 EA
660-TC2B	½" O.D. compression tee for ½" O.D. dishwasher tube	25	25	18.00 EA
660-TB	⅝" O.D. compression tee for ½" nom. copper tube	25	25	17.85 EA
BAR-CODED CLAMSHELLS IN A CUT CASE BOX				
660-TC0	¼" O.D. compression tee for ice maker tube	6	6	18.75 EA
660-TC1	¾" O.D. compression tee for supply tube	6	6	19.25 EA
660-TC2	½" O.D. compression tee for ½" O.D. dishwasher tube	6	6	19.50 EA
660-T	⅝" O.D. compression tee for ½" nom. copper tube	6	6	19.35 EA
FEMALE COMPRESSION TEE				
BULK				
660-TR1B	¾" O.D. comp. × ¾" O.D. female comp.	25	25	17.25 EA
660-TR2B	½" O.D. comp. × ½" O.D. female comp.	25	25	18.25 EA
660-TRB	⅝" O.D. comp. × ⅝" O.D. female comp.	25	25	17.65 EA
BAR-CODED CLAMSHELLS IN A CUT CASE BOX				
660-TR1	¾" O.D. comp. × ¾" O.D. female comp.	6	6	18.75 EA
660-TR2	½" O.D. comp. × ½" O.D. female comp.	6	6	19.75 EA
660-TR	⅝" O.D. comp. × ⅝" O.D. female comp.	6	6	19.15 EA

SUPPLY

DRAINAGE

SUPPORT

TESTING

SPECIALTIES

TOOLS

ACCESS



Hydra-Rester[®] Commercial Water Hammer Arrester

- Certified by the American Society of Sanitary Engineering to the ANSI/ASSE 1010-2004 Standard
- Lifetime cycle tested at U.S. Testing Laboratories to withstand 10,000 shock cycles. Factory tested to withstand 500,000 cycles without failure (654-C tested)
- Hydra-Rester male sweat fittings are compatible with press-fit fitting systems, such as Ridgid-Viega ProPress™ and all push-fit fitting systems such as Cash Acme SharkBite®
- Allows for installation in 2×4 wall cavity
- Installs at any angle
- ASSE 1010 certified as a water hammer arrester that is “designed to provide continuous protection, without maintenance” allowing the Hydra-Rester to be installed without access panels

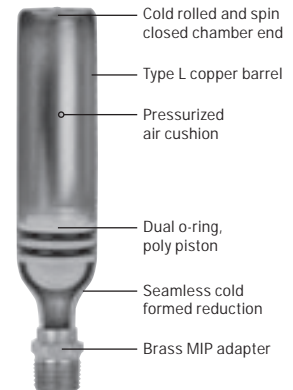

Specifications	
Maximum Working Temp	250°F
Maximum Working Pressure for Pressure Testing	350 PSIG
Burst Tested	2,900 PSIG



Item No.	Conn. Size	Unit Size	Dimensions		Fixture Unit Value	Cubic Inch Volume	Min. Qty.	Case Qty.	List Price
			Length	Width					
MIP THREAD									
652-A	½"	A	6½"	1⅜"	1-11	5	1	16	17.40 EA
653-B	¾"	B	8¾"	1⅜"	12-32	7	1	16	20.90 EA
654-C	1"	C	11"	1⅜"	33-60	11	1	16	50.90 EA
655-D	1"	D	10¼"	2½"	61-113	20	1	4	65.75 EA
656-E	1"	E	12⅝"	2½"	114-154	29	1	4	87.75 EA
657-F	1"	F	15½"	2½"	155-330	36	1	4	134.25 EA
MALE SWEAT									
652-AS	½"	A	8¼"	1⅜"	1-11	5	1	16	17.15 EA
653-BS	¾"	B	10"	1⅜"	12-32	7	1	16	20.40 EA
654-CS	1"	C	12½"	1⅜"	33-60	11	1	16	49.90 EA
655-DS	1"	D	11"	2½"	61-113	20	1	4	64.75 EA
656-ES	1"	E	13½"	2½"	114-154	29	1	4	86.75 EA
657-FS	1"	F	16"	2½"	155-330	36	1	4	133.25 EA

Sizing and Placement

The fixture unit values shown in the table (below) represent the standard ratings used by engineers to size water distribution systems as well as water hammer arresters. Match fixture units in the table to the Hydra-Rester with the corresponding fixture unit value (see previous page).

Fixture	Type of Supply Control	Fixture Units					
		Public			Private		
		Total	C.W.	H.W.	Total	C.W.	H.W.
Water closet	Flush valve	10	10	—	6	6	—
Water closet	Flush tank	5	5	—	3	3	—
Pedestal urinal	Flush valve	10	10	—	—	—	—
Stall or wall urinal	Flush valve	5	5	—	—	—	—
Stall or wall urinal	Flush tank	3	3	—	—	—	—
Lavatory	Faucet	2	1½	1½	1	1	1
Bath tub	Faucet	4	2	3	2	1½	1½
Shower head	Mixing valve	4	2	3	2	1	2
Bathroom group	Flush valve closet	—	—	—	8	8	3
Bathroom group	Flush tank closet	—	—	—	6	6	3
Separate shower	Mixing valve	—	—	—	2	1	2
Service sink	Faucet	3	3	3	—	—	—
Laundry tubs (1-3)	Faucet	—	—	—	3	3	3
Combination fixture	Faucet	—	—	—	3	3	3

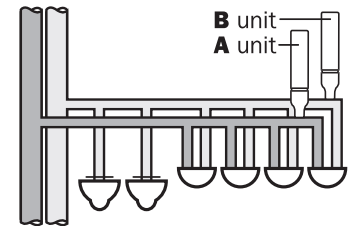

Cold Water
Equal to 26 fixture units
Requires B unit
Sioux Chief's 653-B or 653-BS

Hot Water
Equal to 6 fixture units
Requires A unit
Sioux Chief 652-A or 652-AS

Multi-Fixture Branch Lines

Rule 1: Branch Lines of 20 Feet or Less The Hydra-Rester should be placed at the end of the branch line within six feet of the last fixture served, as shown. Select required model using fixture unit sizing (above). Always place arrester within six feet of the last fixture.

Rule 2: Branch lines over 20 feet An additional Hydra-Rester (Y) should be placed as shown. The additional unit should be placed at the midpoint of the run longer than 20 feet. Select required model(s) using fixture unit sizing (above). The sum of the fixture unit ratings of units X and Y combined, shall be equal to or greater than the demand of all branches.

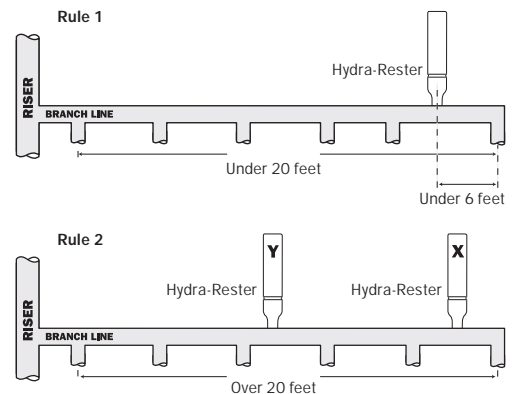

Long Runs of Piping to Remote Equipment

When long runs of piping serve remote equipment, we recommend custom sizing for each specific application. If you have such an application, fill out our arrester sizing form on the next page and fax it to us. Your specific job will be analyzed and calculated by our sizing program. The results will be sent to you, including the required arrester size and information on how to order.

Residential Installations

For High-Flow Garden Tub Valves and Multi-Head Shower Valves, install 653-B Hydra-Resters on both hot and cold supply lines within six feet of the valve.

For Lawn Irrigation Zone Valves, on ¾" service line, install one 653-B Hydra-Rester within six feet of each valve or group of valves. On 1" service line: Install one 654-C Hydra-Rester within six feet of each valve or group of valves.

Water Hammer Arrester Cross Reference

Manufacturer (Trade Name)	Arrester Size						
	AA	A	B	C	D	E	F
Sioux Chief (Mini-Rester, Hydra-Rester)	660 Series	652-A	653-B	654-C	655-D	656-E	657-F
Josam (Absorbotron)	—	75001	75002	75003	75004	75005	75006
J.R. Smith (Hydrotrol)	—	5005	5010	5020	5030	5040	5050
PPP (MM, SC Series)	MM-500 Series	SC500	SC750	SC1000	SC1250	SC1500	SC2000
Wade (Shokstop)	—	W-5	W-10	W-20	W-50	W-75	W-100
Watts (05, 15 Series)	05 Series	15-½"	15-¾"	15-1"	15-1¼"	15-1½"	15-2"
Zurn (Shoktrol)	—	100	200	300	400	500	600

SUPPLY



658-4004

DRAINAGE



658-4004F2

SUPPORT

TESTING



658S2002

SPECIALTIES

TOOLS



658S4004F2

ACCESS

Mega-Rester™ Industrial Water Hammer Arrester

Copper

- Dual o-ring piston lubricated with Dow 111 FDA approved silicone compound
- Cast brass flange, or wrought copper male thread fitting with lead-free solder joints
- 4" nominal Type L copper tube barrel
- 600 lb. (40 bar) liquid filled gauge
- Factory air charge

Stainless Steel

- Dual o-ring piston lubricated with Dow 111 FDA approved silicone compound
- Welded stainless steel flange or male thread fitting
- 4.25" O.D. 316 stainless steel barrel
- 600 lb. (40 bar) liquid filled gauge
- Factory air charge

Item No.	Connection Size & Type	Volume (in ³)	Height (in)	Min. Qty.	Case Qty.	List Price
COPPER						
658-1503	3" MIP (ANSI B2.1)	150	23.25	1	1	1,250.00 EA
658-2002	2" MIP (ANSI B2.1)	200	29.25	1	1	1,250.00 EA
658-2004	4" MIP (ANSI B2.1)	200	24.50	1	1	1,315.00 EA
658-4004	4" MIP (ANSI B2.1)	400	40.50	1	1	1,635.00 EA
658-4004F2	4" Class 150 Flange (ANSI B16.24)	400	39.75	1	1	1,815.00 EA
STAINLESS STEEL						
658S2002	2" MIP (ANSI B2.1)	200	24.25	1	1	3,360.00 EA
658S2004F2	4" Class 150 Flange (ANSI B16.24)	200	22.87	1	1	3,920.00 EA
658S4004F2	4" Class 150 Flange (ANSI B16.24)	400	38.87	1	1	4,500.00 EA

Arrester Sizing Service

Fax this completed form to Sioux Chief. Our expert sizing program will calculate exactly what size arrester is right for your project.

Nominal pipe size _____

Type of pipe _____

Effective pipe length _____

Flow pressure _____

Flow rate _____

Brief description of application _____

Name _____

Company _____

Project name _____

Phone _____

Fax _____

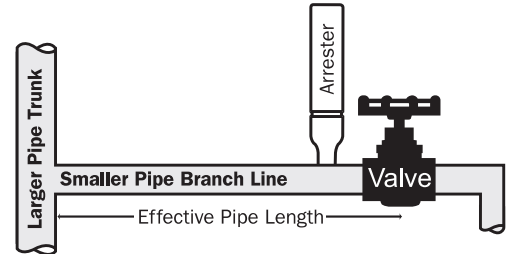

The effective pipe length runs from the valve, upstream to a trunk line, usually of larger diameter piping. The properly sized arrester should be placed upstream of the valve and as close to it as possible.

Fax to Sioux Chief at 1-800-758-5950 or 1-816-758-5950 (outside US). Arrester Sizing Service Form is also available at www.siouxchief.com.

SUPPLY

DRAINAGE

SUPPORT

TESTING

SPECIALTIES

TOOLS

ACCESS



SUPPLY

DRAINAGE

SUPPORT

TESTING

SPECIALTIES

TOOLS

ACCESS

Water Hammer from a Vacuum

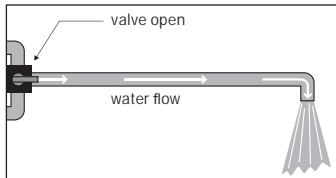

Valve open, normal water flow.

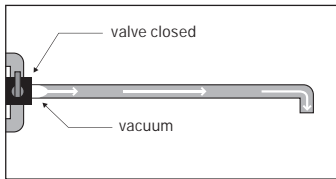

Valve closes. Water momentum downstream creates a vacuum at the valve.

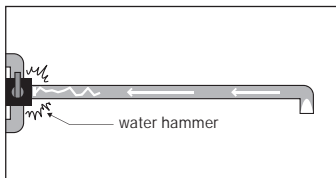

The vacuum pulls the water column back toward the valve at high velocity.

How the Vacu-Rester Works

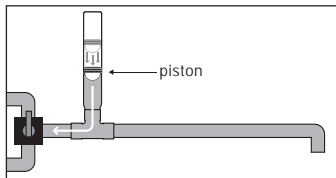

The Vacu-Rester piston is pulled by the vacuum rather than the water column, preventing cavitation and reducing water hammer.

Specifications

Maximum Working Temp	250°F
Maximum Working Pressure for Pressure Testing	350 PSIG
Burst Tested	2,900 PSIG

**Vacu-Rester™
Vacuum Breaker Arrester**

- To prevent cavitation and accompanying water hammer within the extra-long tub spout tubes and/or shower risers of high-flow fixtures, such as garden tub valves and multi-head shower valves
- Unlike atmospheric vacuum breaker devices that can leak or spit, the Vacu-Rester's "closed atmosphere" chamber serves as a vacuum breaker without the chance of leaks
- Recommended by Kohler Company for their high-flow tub valves such as their SOK™ series fixtures

Installation

For high flow tub valves with long spout tubes, install 652-AD Vacu-Rester on spout tube, in between tub valve and spout, within one foot of the tub valve.

For high flow shower valves, install 652-AD Vacu-Rester on shower riser, in between shower valve and shower head, within one foot of the shower valve.

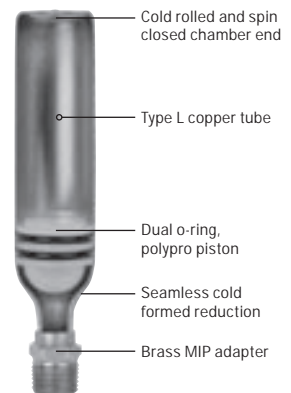

Item No.	Conn. Size	Unit Size	Dimensions		Min. Qty.	Case Qty.	List Price
			Length	Width			
MIP THREAD							
652-AD	½"	A	6½"	1⅜"	1	16	18.40 EA
657-FD	1"	F	15⅝"	2⅜"	1	4	134.25 EA

Prime Perfect™ Trap Primer Valve

- Automatically activates to replenish evaporated water in floor drain traps to prevent the escape of sewer gases
- Large port openings prevent clogging from sediment and debris
- Activates with a 10 PSIG pressure drop at operating pressure of 30–150 PSIG
- Water release is factory set 0.25 oz per activation. No field adjustment necessary
- Accepted by the Oregon State Board of Health, the Army Corps of Engineers, the City of Los Angeles, and engineers all over the U.S.
- UPC/IAPMO listed
- Certified by the American Society of Sanitary Engineering to the ASSE 1018-2001 Standard
- Brass plated cap and body

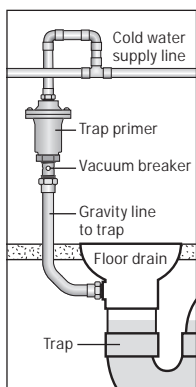

Installation

Install to a convenient cold water line, ½"–1½" (12–40 mm) in diameter, nearest the trap or traps to be served. Install in the upright, vertical position only. Install at least 5" (152 mm) above the grid of the floor drain or the flood rim of the sink or fixture which the trap serves. Install near plumbing fixtures to insure a full pressure drop of 10 PSI or more. If trap primer is installed too far upstream in the system, the pressure drop may not be enough for activation. To help prevent sediment buildup, install a vertical loop that rises above the supply line tee. (See illustration left.) Flush trap primer branch line prior to installing the trap primer. Install MIP adapter. Thread on trap primer. Install FIP union to bottom. Use PTFE tape sealant on both connections. Do not use pipe dope. Do not solder or braze directly to trap primer or fittings installed in trap primer. Water discharge is factory set—no adjustment is required on normal installations. However, for static pressures over 100 PSI, adjustments may be necessary. First loosen the nipple locknut, then turn the nipple counter clockwise until the trap primer starts dripping, turn the nipple clockwise ¼ turn, and re-tighten nipple locknut.

Components

- | | |
|----------------------------|------------------------------------|
| 1 Body: Brass-plated Zamac | 11 Diaphragm spring retainer |
| 2 Cap: Brass-plated Zamac | 12 Sediment screen |
| 3 Brass nipple | 13 Valve stem |
| 4 Valve washer | 14 Diaphragm adjustment nut |
| 5 Valve stem nut | 15 Nipple locknut |
| 6 Rubber valve disc | 16 Diaphragm |
| 7 Nipple seat washer | 17 Hex head stainless steel screws |
| 8 Valve stem guide | 18 Diaphragm stop washer |
| 9 Valve stem spring | 19 Vacuum breaker |
| 10 Diaphragm spring | |

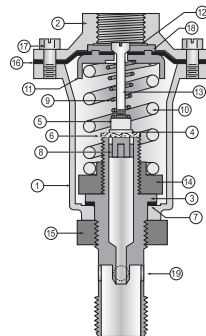

Specifications

Inlet	½" FIP
Diameter	2 ¾"
Outlet	½" MIP
Length	5 ¼"
Working Pressure	30–250 PSIG

Item No.	Description	Min. Qty.	Case Qty.	List Price
695-01	Prime Perfect trap primer valve	1	24	56.75 EA





695-Y52



695-D20



695-D4325



695-D432F

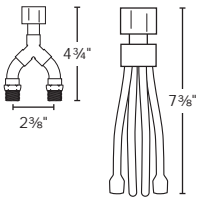

Splitters

Wye Splitter

- 1/2" FIP swivel connection
- Use with trap primer distributors (below) to service up to eight traps from a single trap primer

Distributor

Patent Pending

- 1/2" FIP swivel connection
- Available with two, three or four flexible copper branches
- Evenly distributes water to each branch every time

Item No.	Description	Min. Qty.	Case Qty.	List Price
WYE SPLITTER				
695-Y52	Two 1/2" MIP branches	1	10	31.75 EA
DISTRIBUTOR				
695-D20	Two 1/4" male sweat branches	1	16	17.30 EA
695-D30	Three 1/4" male sweat branches	1	16	19.00 EA
695-D40	Four 1/4" male sweat branches	1	16	21.25 EA
695-D432	Two 1/4" male sweat branches Two spin-closed branches	1	16	21.25 EA
695-D432F	Four 1/2" FIP branches with two plugs	1	10	31.75 EA
695-D4325	Two 1/2" female sweat branches Two spin-closed branches	1	16	21.75 EA

Trap-Ease™ Trap Primer Tailpiece

- Gravity feed, no mechanical parts
- Replenishes water in floor drain traps to prevent the escape of sewer gases
- 1/2" nominal branch connection



200-092



213-090

Item No.	Dimensions	Tubular Connection	Gauge	Finish	Min. Qty.	Case Qty.	List Price
200-090	1 1/2" x 8"	direct connect	22	unfinished	25	25	9.45 EA
200-092	1 1/2" x 8"	direct connect	22	chrome	25	25	10.45 EA
213-090	1 1/4" x 6"	fine thread	20	unfinished	25	25	8.45 EA
213-092	1 1/4" x 6"	fine thread	20	chrome	25	25	9.35 EA

Drainage

Commercial

- On-Grade Drains
- Large Capacity Drains
- Flashing Drains
- Roof Drains
- Cleanouts

Residential

- Shower Drains
- Floor Drains
- Closet Flanges
- Backwater Valves

Accessories

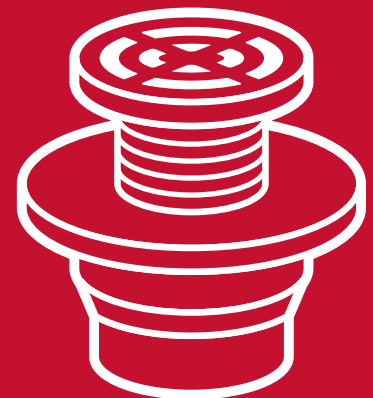

Drainage

SUPPLY

DRAINAGE

SUPPORT

TESTING

SPECIALTIES

TOOLS

ACCESS

COMMERCIAL DRAINAGE

On-Grade Drains

- 110-112 Finish Line™
- 113-116 PVC MIP Thread Adjustable Floor Drain
- 117 Cast Iron MIP Thread Adjustable Floor Drain
- 118 Sch. 40 Hub On-Grade Floor Drain
- 119 Sch. 40 Hub On-Grade Floor Drain
- 120 Cast Iron No-Hub On-Grade Floor Drain

Large Capacity Drains

- 121 Little Max™
- 121 Cast Iron Square Floor Sink
- 122 Square Max™
- 123 Square Max™ Options
- 123 Square Max™ Accessories
- 124 Fat Max™
- 125 Fat Max™ Options
- 126 Fat Max™ Accessories
- 126 Stainless Steel Fat Max™

Flashing Drains

- 127-130 Finish Line™
- 131-132 Sch. 40 Hub Flashing Drain
- 133 Cast Iron No-Hub Flashing Drain
- 134 Cast Iron Push-Joint Flashing Drain

Roof Drains

- 135 867 Series Roof Drain
- 136 868 Series ABS/PVC Roof Drain
- 137 868 Series Cast Iron Roof Drain

Cleanouts

- 139-141 Finish Line™
- 142-144 PVC MIP Thread Adjustable Cleanout
- 145 Cast Iron MIP Thread Adjustable Cleanout
- 146 ABS/PVC Connection Adjustable Cleanout
- 147 Cast Iron No-Hub Adjustable Cleanout
- 148 Cast Iron Push-Joint Adjustable Cleanout
- 150 Cleanout Cover
- 151 Cleanout Cover Kit
- 152 Cleanout Cover Accessories
- 152 Cleanout Bushing

RESIDENTIAL DRAINAGE

Shower Drains

- 154-155 Shower Pan Drain
- 156 ABS/PVC Shower Module Drain
- 157 No-Caulk Shower Module Drain
- 157 JackRabbit™
- 158 Push-Joint/Solvent Weld Shower Module Drain
- 158 ABS/PVC Offset Shower Module Drain

Floor Drains

- 159 Weld One™
- 159 Backwater Device
- 160 2" x 3" Quad Drain™
- 160 3" x 4" Quad Drain™
- 161 Atlas Drain™
- 161 Inside Pipe Drain
- 162 General Purpose Floor Drain
- 163 Gripper®
- 163 Replace-It™
- 164 Bell Trap Drain
- 164 PVC Vent Cap
- 165 Philadelphia Style Vent Cap
- 165 Pittsburgh Style Drain
- 165 St. Louis Style Drain

Closet Flanges

- 165 TKO™
- 166 Push-Tite™
- 167 Open Closet Flange
- 167 Full Flush™
- 168 Drop-Kick™
- 168 Cast Iron Closet Flange
- 168 Brass Closet Flange Ring
- 169 Quick Spacer™
- 169 Ringer™
- 169 Raise-A-Ring™
- 170 Urinal Flange Kit

Backwater Valves

- 173 DWV Backwater Valve

DRAINAGE ACCESSORIES

- 176 Slotted Polypro Flush Plug
- 177 Brass Flush Plug
- 178 PVC Flush Plug—Spanner
- 178 Standard Adapter
- 179 Slab-Grab™
- 179 Fitting Socket Adapter
- 179 Push-Joint Adapter
- 180 No-Hub Adapter
- 180 Flashing Drain Adapter
- 181-183 Replacement Strainer for Drains
- 183 Replacement Strainer for Roof Drains
- 183 Replacement Strainer/Vent Cap for Drains
- 184 Cast Iron Strainer
- 184-185 Replacement Covers for Cleanouts
- 186 Bits For Vandal-Resistant Screws
- 186 Pipe Bore Adapter
- 187 Backup Float Valve
- 187 Smart Saddle™

Commercial Drainage

On-Grade Drains
Large Capacity Drains
Flashing Drains
Roof Drains
Cleanouts

SUPPLY

DRAINAGE

SUPPORT

TESTING

SPECIALTIES

TOOLS

ACCESS



SUPPLY

DRAINAGE

SUPPORT

TESTING

SPECIALTIES

TOOLS

ACCESS

Finish Line™ Adjustable Floor Drain

The Finish Line allows for adjustment of the drain after the pour. Achieve a perfect finish for every strainer, every time.

Installing the Finish Line



Set Drain

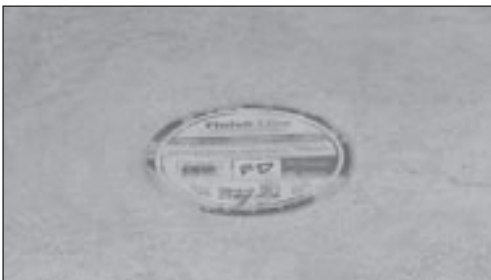

Pour Concrete



Remove Coring Plug



Install Finish Fixture

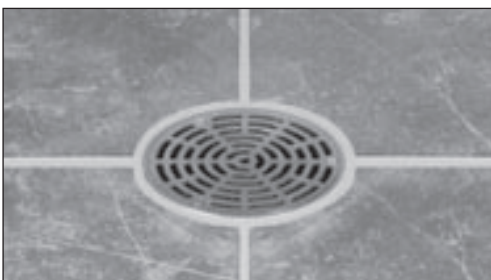

A Perfect Finish



Finish Fixture



Coring Plug



Coring Sleeve



Base Adapter

Eliminate drains set too high or too low.
Stop wrapping threads and boxing out.



Eliminate Finish Fixture damage by
keeping them off the job during construction.

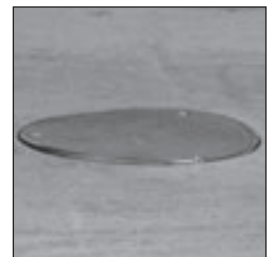
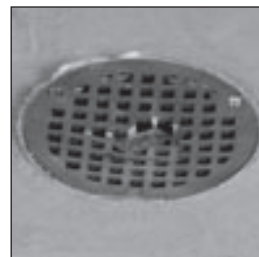

Finish Line™ Adjustable Floor Drain

Ductile Iron available
April 2007

Ductile Iron No-Hub Connection

- Adjustable AFTER the pour
- Ductile iron Base Adapter, Coring Sleeve, and Head Adapter. Poly Coring Plug
- Nickel strainers for use in pedestrian areas. Ductile iron strainers for use in heavy duty applications

SUPPLY

DRAINAGE



832-3DIR

SUPPORT



832-4DNQ

TESTING

SPECIALTIES



832-S4

TOOLS

ACCESS



Rough-in Drain is packaged fully assembled with Coring Plug, Coring Sleeve, and Base Adapter.

Finish Fixture is individually boxed and labelled. Order separately.

Complete Assembly is packaged with a fully assembled Rough-in Drain and a separately boxed Finish Fixture.

Options: Add letter suffix. Add prices to list.
V – Vandal-resistant screws \$5.00
E – Extended ring* \$49.00
 *E is only available on Finish Fixtures and Complete Assemblies with round nickel ring and strainer.

Item No.	Ring & Strainer	Dimensions				Min. Qty.	Case Qty.	List Price
		A	B	C	D			
ROUGH-IN DRAIN								
832-3DF	–	3"	–	4.4"	5.3"–6.55"	1	1	37.00 EA
832-4DF	–	4"	–	4.6"	5.5"–6.75"	1	1	40.00 EA
FINISH FIXTURE								
832-4DHiR	round ductile	–	6½"	–	–	1	1	56.00 EA
832-4DHNR	round nickel	–	6½"	–	–	1	1	63.00 EA
832-4DHNQ	square nickel	–	7¼"	–	–	1	1	79.00 EA
COMPLETE ASSEMBLY								
832-3DiR	round ductile	3"	6½"	4.4"	5.3"–6.55"	1	1	94.00 EA
832-3DNr	round nickel	3"	6½"	4.4"	5.3"–6.55"	1	1	101.00 EA
832-3DNQ	square nickel	3"	7¼"	4.4"	5.5"–6.75"	1	1	117.00 EA
832-4DiR	round ductile	4"	6½"	4.6"	5.5"–6.75"	1	1	97.00 EA
832-4DNR	round nickel	4"	6½"	4.6"	5.3"–6.55"	1	1	104.00 EA
832-4DNQ	square nickel	4"	7¼"	4.6"	5.3"–6.55"	1	1	120.00 EA
ACCESSORIES								
832-S4	Two adjustment shims, two ¼" screws					1	10	9.00 EA

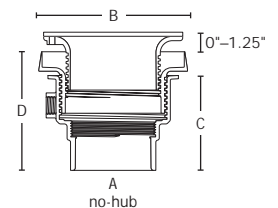

Finish Line™ Adjustable Floor Drain

Sch. 40 Hub Connection

- Adjustable AFTER the pour
- ABS/PVC Base Adapter, ABS Coring Sleeve and Head Adapter. Poly Coring Plug
- For use in pedestrian traffic areas



832-36ANR



832-4PNQ



Rough-in Drain is packaged fully assembled with Coring Plug, Coring Sleeve, and Base Adapter.



Finish Fixture is individually boxed and labelled. Order separately.



Complete Assembly is packaged with a fully assembled Rough-in Drain and a separately boxed Finish Fixture.

Options: Add letter suffix. Add prices to list.
V – Vandal-resistant screws \$5.00
E – Extended ring* \$49.00
 *E is only available on Finish Fixtures and Complete Assemblies with round ring and strainer.



832-S4

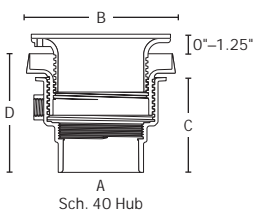

PVC Item No.	ABS Item No.	Ring & Strainer	Dimensions				Min. Qty.	Case Qty.	List Price
			A	B	C	D			
ROUGH-IN DRAIN									
832-36PF	832-36AF	—	3"	—	4.4"	5.3"–6.55"	1	1	18.75 EA
832-4PF	832-4AF	—	4"	—	4.6"	5.5"–6.75"	1	1	19.75 EA
FINISH FIXTURE									
832-4HNR		round nickel	—	6 1/2"	—	—	1	1	47.50 EA
832-4HBR		round brass	—	6 1/2"	—	—	1	1	57.50 EA
832-4HNQ		square nickel	—	7 1/16"	—	—	1	1	63.25 EA
832-4HBQ		square brass	—	6 11/16"	—	—	1	1	74.75 EA
COMPLETE ASSEMBLY									
832-36PNR	832-36ANR	round nickel	3"	6 1/2"	4.4"	5.3"–6.55"	1	1	67.25 EA
832-36PBR	832-36ABR	round brass	3"	6 1/2"	4.4"	5.3"–6.55"	1	1	77.25 EA
832-4PNR	832-4ANR	round nickel	4"	6 1/2"	4.6"	5.5"–6.75"	1	1	68.25 EA
832-4PBR	832-4ABR	round brass	4"	6 1/2"	4.6"	5.5"–6.75"	1	1	78.25 EA
832-36PNQ	832-36ANQ	square nickel	3"	7 1/16"	4.4"	5.3"–6.55"	1	1	83.00 EA
832-36PBQ	832-36ABQ	square brass	3"	6 11/16"	4.4"	5.3"–6.55"	1	1	94.50 EA
832-4PNQ	832-4ANQ	square nickel	4"	7 1/16"	4.6"	5.5"–6.75"	1	1	84.00 EA
832-4PBQ	832-4ABQ	square brass	4"	6 11/16"	4.6"	5.5"–6.75"	1	1	95.50 EA
ACCESSORIES									
832-S4	Two adjustment shims, two 3/4" screws		1	10	9.00 EA				

Adjustable Floor Drain PVC MIP Thread

Round Cast Metal Ring and Strainer

- PVC head adapter with ABS or PVC adapter available
- Three brass female thread inserts accept strainer screws
- For use in pedestrian traffic areas
- MIP thread adapts to any standard FIP adapter



842-3PNR



842-3LNR



E option for condensate drain applications

Related Products

Replacement Strainers p 181
Available Adapters p 178-180

Options: Add letter suffix. Add prices to list.

- V – Vandal-resistant screws \$5.00
- 8 – Tapped flanged adapter* \$5.75
- 9 – Fitting socket ring* -\$0.75
- E – Extended ring* \$49.00

*8 and 9 only apply to items with adapter.
*E is only available on 6 1/2" rings ('B' dimension).

PVC Item No.	ABS Item No.	Ring & Strainer	Dimensions			Min. Qty.	Case Qty.	List Price
			A	B	C			
WITH ADAPTER								
INDIVIDUALLY BAR-CODED BULK								
842-2PNR	842-2ANR	nickel	2" hub	4 1/2"	3 5/8" – 5"	1	10	33.50 EA
842-3PNR	842-3ANR	nickel	3" hub	5 1/2"	4 1/4" – 5 1/2"	1	8	43.00 EA
842-36PNR	842-36ANR	nickel	3" hub	6 1/2"	4 1/4" – 5 1/2"	1	10	53.00 EA
842-4PNR	842-4ANR	nickel	4" hub	6 1/2"	4 1/2" – 5 3/4"	1	10	54.00 EA
842-2PBR	842-2ABR	brass	2" hub	4 1/2"	3 5/8" – 5"	1	10	41.75 EA
842-3PBR	842-3ABR	brass	3" hub	5 1/2"	4 1/4" – 5 1/2"	1	8	55.25 EA
842-36PBR	842-36ABR	brass	3" hub	6 1/2"	4 1/4" – 5 1/2"	1	10	66.50 EA
842-4PBR	842-4ABR	brass	4" hub	6 1/2"	4 1/2" – 5 3/4"	1	10	67.50 EA
INDIVIDUALLY BAR-CODED IN A CUT CASE BOX								
842-2PNRPK	—	nickel	2" hub	4 1/2"	3 5/8" – 5"	6	6	34.77 EA
842-3PNRPK	—	nickel	3" hub	5 1/2"	4 1/4" – 5 1/2"	5	5	44.27 EA
NO ADAPTER								
INDIVIDUALLY BAR-CODED BULK								
842-2LNR		nickel	2" MIP	4 1/2"	—	1	10	30.00 EA
842-3LNR		nickel	3" MIP	5 1/2"	—	1	10	37.00 EA
842-36LNR		nickel	3" MIP	6 1/2"	—	1	10	45.75 EA
842-4LNR		nickel	4" MIP	6 1/2"	—	1	10	46.75 EA
842-2LBR		brass	2" MIP	4 1/2"	—	1	10	38.25 EA
842-3LBR		brass	3" MIP	5 1/2"	—	1	10	49.25 EA
842-36LBR		brass	3" MIP	6 1/2"	—	1	10	59.25 EA
842-4LBR		brass	4" MIP	6 1/2"	—	1	10	60.25 EA
INDIVIDUALLY BAR-CODED IN A CUT CASE BOX								
842-3LNRPK		nickel	3" MIP	5 1/2"	—	5	5	38.27 EA

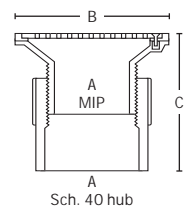

SUPPLY

DRAINAGE

SUPPORT

TESTING

SPECIALTIES

TOOLS

ACCESS



842-3PNQ



842-3LNQ

Adjustable Floor Drain PVC MIP Thread

Square Cast Metal Ring and Strainer

- PVC head adapter with ABS or PVC adapter available
- Square ring is great for square floor tile
- Three brass female thread inserts accept strainer screws
- For use in pedestrian traffic areas
- MIP thread adapts to any standard FIP adapter

Related Products	
Replacement Strainers	p 181
Available Adapters	p 178-180

Options: Add letter suffix. Add prices to list.
V – Vandal-resistant screws \$5.00
8 – Tapped flanged adapter* \$5.75
9 – Fitting socket ring* –\$0.75
 *8 and 9 only apply to items with adapter.

PVC Item No.	ABS Item No.	Ring & Strainer	Dimensions			Min. Qty.	Case Qty.	List Price
			A	B	C			
WITH ADAPTER								
INDIVIDUALLY BAR-CODED BULK								
842-2PNQ	842-2ANQ	nickel	2" hub	4 ⁹ / ₁₆ "	3 ⁵ / ₈ " – 5"	1	10	49.50
842-3PNQ	842-3ANQ	nickel	3" hub	5 ¹¹ / ₁₆ "	4 ¹ / ₄ " – 5 ¹ / ₂ "	1	10	61.50 EA
842-36PNQ	842-36ANQ	nickel	3" hub	7 ¹ / ₁₆ "	4 ¹ / ₄ " – 5 ¹ / ₂ "	1	1	71.60 EA
842-4PNQ	842-4ANQ	nickel	4" hub	7 ¹ / ₁₆ "	4 ¹ / ₂ " – 5 ³ / ₄ "	1	1	72.60 EA
842-2PBQ	842-2ABQ	brass	2" hub	4 ⁹ / ₁₆ "	3 ⁵ / ₈ " – 5"	1	10	58.50 EA
842-3PBQ	842-3ABQ	brass	3" hub	5 ¹¹ / ₁₆ "	4 ¹ / ₄ " – 5 ¹ / ₂ "	1	10	74.25 EA
842-36PBQ	842-36ABQ	brass	3" hub	6 ¹¹ / ₁₆ "	4 ¹ / ₄ " – 5 ¹ / ₂ "	1	1	83.10 EA
842-4PBQ	842-4ABQ	brass	4" hub	6 ¹¹ / ₁₆ "	4 ¹ / ₂ " – 5 ³ / ₄ "	1	10	84.10 EA
NO ADAPTER								
INDIVIDUALLY BAR-CODED BULK								
	842-2LNQ	nickel	2" MIP	4 ⁹ / ₁₆ "	–	1	5	46.00 EA
	842-3LNQ	nickel	3" MIP	5 ¹¹ / ₁₆ "	–	1	5	55.50 EA
	842-36LNQ	nickel	3" MIP	7 ¹ / ₁₆ "	–	1	5	64.35 EA
	842-4LNQ	nickel	4" MIP	7 ¹ / ₁₆ "	–	1	5	65.35 EA
	842-2LBQ	brass	2" MIP	4 ⁹ / ₁₆ "	–	1	1	55.00 EA
	842-3LBQ	brass	3" MIP	5 ¹¹ / ₁₆ "	–	1	1	68.25 EA
	842-36LBQ	brass	3" MIP	6 ¹¹ / ₁₆ "	–	1	1	75.85 EA
	842-4LBQ	brass	4" MIP	6 ¹¹ / ₁₆ "	–	1	1	76.85 EA

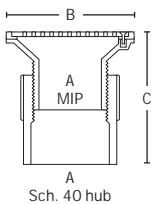

SUPPLY

DRAINAGE

SUPPORT

TESTING

SPECIALTIES

TOOLS

ACCESS

Adjustable Floor Drain PVC MIP Thread

Cast Iron Ring and Strainer

- PVC head adapter with ABS or PVC adapter available
- For use in heavy duty applications
- Three brass female thread inserts accept ring screws
- MIP thread adapts to any standard FIP adapter



842-3Pi



842-3Li

SUPPLY

DRAINAGE

SUPPORT

TESTING

SPECIALTIES

TOOLS

ACCESS

Related Products		
Replacement Strainers	p 181	
Available Adapters	p 178-180	

Options: Add letter suffix. Add prices to list.

8 – Tapped flanged adapter* \$5.75

9 – Fitting socket ring* –\$0.75

***8** and **9** only apply to items with adapter.

PVC item No.	ABS item No.	Ring & Strainer	Dimensions			Min. Qty.	Case Qty.	List Price
			A	B	C			
WITH ADAPTER								
INDIVIDUALLY BAR-CODED BULK								
842-2Pi	842-2Ai	cast iron	2" hub	5"	4 $\frac{1}{8}$ " – 5 $\frac{1}{2}$ "	1	2	33.50 EA
842-3Pi	842-3Ai	cast iron	3" hub	6 $\frac{1}{16}$ "	4 $\frac{11}{16}$ " – 5 $\frac{15}{16}$ "	1	2	44.50 EA
842-36Pi	842-36Ai	cast iron	3" hub	6 $\frac{11}{16}$ "	4 $\frac{11}{16}$ " – 5 $\frac{15}{16}$ "	1	2	50.00 EA
842-4Pi	842-4Ai	cast iron	4" hub	6 $\frac{11}{16}$ "	5 $\frac{1}{8}$ " – 6 $\frac{3}{8}$ "	1	2	51.00 EA
NO ADAPTER								
INDIVIDUALLY BAR-CODED BULK								
842-2Li		cast iron	2" MIP	5"	–	1	5	30.00 EA
842-3Li		cast iron	3" MIP	6 $\frac{1}{16}$ "	–	1	5	38.50 EA
842-36Li		cast iron	3" MIP	6 $\frac{11}{16}$ "	–	1	5	42.75 EA
842-4Li		cast iron	4" MIP	6 $\frac{11}{16}$ "	–	1	5	43.75 EA

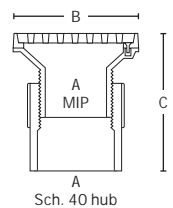



842-3PP

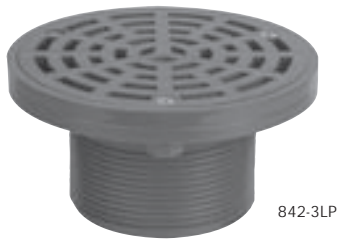

842-3LP

Adjustable Floor Drain PVC MIP Thread

PVC Strainer

- PVC head adapter with ABS or PVC adapter available
- For use in pedestrian traffic areas
- Three brass female thread inserts accept strainer screws
- MIP thread adapts to any standard FIP adapter

Related Products	
Replacement Strainers	p 181
Available Adapters	p 178-180

Options: Add letter suffix. Add prices to list.
V – Vandal-resistant screws \$5.00
8 – Tapped flanged adapter* \$5.75
9 – Fitting socket ring* –\$0.75
 ***8** and **9** only apply to items with adapter.

PVC Item No.	ABS Item No.	Strainer	Dimensions			Min. Qty.	Case Qty.	List Price
			A	B	C			
WITH ADAPTER								
INDIVIDUALLY BAR-CODED BULK								
842-2PP	842-2AP	PVC	2" hub	4 1/2"	3 5/8" – 5"	1	10	12.50 EA
842-3PP	842-3AP	PVC	3" hub	5 1/2"	4 1/4" – 5 1/2"	1	8	18.50 EA
842-36PP	842-36AP	PVC	3" hub	6 1/2"	4 1/4" – 5 1/2"	1	10	20.25 EA
842-4PP	842-4AP	PVC	4" hub	6 1/2"	4 5/8" – 5 3/8"	1	10	21.25 EA
NO ADAPTER								
INDIVIDUALLY BAR-CODED BULK								
842-2LP		PVC	2" MIP	4 1/2"	–	1	10	9.00 EA
842-3LP		PVC	3" MIP	5 1/2"	–	1	10	12.50 EA
842-36LP		PVC	3" MIP	6 1/2"	–	1	10	13.00 EA
842-4LP		PVC	4" MIP	6 1/2"	–	1	10	14.00 EA

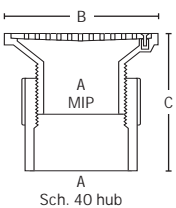

SUPPLY

DRAINAGE

SUPPORT

TESTING

SPECIALTIES

TOOLS

ACCESS

Adjustable Floor Drain Cast Iron MIP Thread

Round Cast Nickel Ring and Strainer

- MIP thread connection adapts to standard FIP adapters
- Extended ring option available for use in condensate drain applications
- For use in pedestrian traffic areas



842-3iLNR

Square Cast Nickel Ring and Strainer

- Square ring is great for square floor tile
- MIP thread connection adapts to standard FIP adapters
- For use in pedestrian traffic areas



842-3iLNO

Cast Iron Ring and Strainer

- For use in heavy duty applications
- MIP thread connection adapts to standard FIP adapters



842-3iLi



E option for condensate drain applications

Related Products

Replacement Strainers p 181
Available Adapters p 178-180

Options: Add letter suffix. Add prices to list.

V – Vandal-resistant screws* \$5.00

E – Extended ring* \$49.00

***V** not available on cast iron ring and strainer.

***E** is only available on 842-4iLNR.

Item No.	Dimensions			Min. Qty.	Case Qty.	List Price
	A	B	C			
ROUND NICKEL RING & STRAINER						
INDIVIDUALLY BAR-CODED BULK						
842-2iLNR	2" MIP	4 1/2"	2 3/8"	1	2	56.00 EA
842-3iLNR	3" MIP	5 1/2"	2 3/8"	1	2	66.00 EA
842-4iLNR	4" MIP	6 1/2"	2 3/8"	1	2	78.25 EA
SQUARE NICKEL RING & STRAINER						
INDIVIDUALLY BAR-CODED BULK						
842-2iLNO	2" MIP	4 9/16"	2 3/8"	1	1	66.50 EA
842-3iLNO	3" MIP	5 1 1/16"	2 3/8"	1	1	78.25 EA
842-4iLNO	4" MIP	7 1/16"	2 3/8"	1	1	94.10 EA
CAST IRON RING & STRAINER						
INDIVIDUALLY BAR-CODED BULK						
842-2iLi	2" MIP	5"	2 5/8"	1	2	54.00 EA
842-3iLi	3" MIP	6 1/16"	3 1/8"	1	2	61.75 EA
842-4iLi	4" MIP	6 1 1/16"	3 1/8"	1	2	72.50 EA

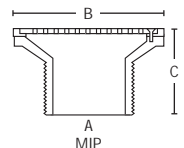



843-3PNR



843-3PNO

On-Grade Floor Drain Sch. 40 Hub Connection

Round Cast Metal Ring and Strainer

- Extended ring option available for use in condensate drain applications
- Three brass female thread inserts accept strainer screws
- For use in pedestrian traffic areas

Square Cast Metal Ring and Strainer

- Square ring is great for square floor tile
- Three brass female thread inserts accept strainer screws
- For use in pedestrian traffic areas



E option for condensate drain applications

Related Products
Replacement Strainers p 181

Options: Add letter suffix. Add prices to list.

V – Vandal-resistant screws \$5.00

E – Extended ring* \$49.00

*E is only available on 6½" ring ('B' dimension).

PVC Item No.	ABS Item No.	Dimensions			Min. Qty.	Case Qty.	List Price
		A	B	C			
ROUND NICKEL RING & STRAINER							
INDIVIDUALLY BAR-CODED BULK							
843-2PNR	843-2ANR	over 2" or inside 3"	4½"	2⅝"	1	10	33.25 EA
843-3PNR	843-3ANR	over 3" or inside 4"	5½"	2½"	1	10	39.00 EA
843-4PNR	843-4ANR	over 4"	6½"	2 ¹⁵ / ₁₆ "	1	4	49.50 EA
ROUND BRASS RING & STRAINER							
INDIVIDUALLY BAR-CODED BULK							
843-2PBR	843-2ABR	over 2" or inside 3"	4½"	2⅝"	1	10	40.00 EA
843-3PBR	843-3ABR	over 3" or inside 4"	5½"	2½"	1	10	48.75 EA
843-4PBR	843-4ABR	over 4"	6½"	2 ¹⁵ / ₁₆ "	1	4	59.50 EA
SQUARE NICKEL RING & STRAINER							
INDIVIDUALLY BAR-CODED BULK							
843-2PNQ	843-2ANQ	over 2" or inside 3"	4 ⁹ / ₁₆ "	2⅝"	1	1	49.25 EA
843-3PNQ	843-3ANQ	over 3" or inside 4"	5 ¹¹ / ₁₆ "	2½"	1	1	55.00 EA
843-4PNQ	843-4ANQ	over 4"	7 ¹ / ₁₆ "	2 ¹⁵ / ₁₆ "	1	1	64.60 EA
SQUARE BRASS RING & STRAINER							
INDIVIDUALLY BAR-CODED BULK							
843-2PBQ	843-2ABQ	over 2" or inside 3"	4 ⁹ / ₁₆ "	2⅝"	1	1	58.50 EA
843-3PBQ	843-3ABQ	over 3" or inside 4"	5 ¹¹ / ₁₆ "	2½"	1	1	67.75 EA
843-4PBQ	843-4ABQ	over 4"	6 ¹¹ / ₁₆ "	2 ¹⁵ / ₁₆ "	1	1	76.10 EA

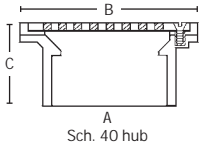

SUPPLY

DRAINAGE

SUPPORT

TESTING

SPECIALTIES

TOOLS

ACCESS

On-Grade Floor Drain Sch. 40 Hub Connection

Cast Iron Ring and Strainer

- For use in heavy duty application
- Three brass female thread inserts accept ring screws

Stainless Steel Strainer

- For use in pedestrian traffic areas
- Three brass female thread inserts accept strainer screws

PVC Strainer

- For use in pedestrian traffic areas
- Three brass female thread inserts accept strainer screws



843-3Pi



843-3PS



843-3PP

SUPPLY

DRAINAGE

SUPPORT

TESTING

SPECIALTIES

TOOLS

ACCESS

Related Products	
Replacement Strainers	p 181
Grip Tip	p 229

Options: Add letter suffix. Add prices to list.

V – Vandal-resistant screws* \$5.00

***V** is not available on cast iron ring and strainer.

PVC item No.	ABS item No.	Dimensions			Strainer Gauge	Min. Qty.	Case Qty.	List Price
		A	B	C				
CAST IRON RING & STRAINER								
INDIVIDUALLY BAR-CODED BULK								
843-2Pi	843-2Ai	over 2" or inside 3"	5"	3 3/8"	–	1	2	31.75 EA
843-3Pi	843-3Ai	over 3" or inside 4"	6 1/16"	3 3/8"	–	1	2	38.00 EA
843-4Pi	843-4Ai	over 4"	6 11/16"	3 1/2"	–	1	2	43.00 EA
STAINLESS STEEL STRAINER								
INDIVIDUALLY BAR-CODED BULK								
843-2PS	843-2AS	over 2" or inside 3"	4 1/2"	2 5/16"	18	1	10	10.75 EA
843-3PS	843-3AS	over 3" or inside 4"	5 1/2"	2 1/4"	18	1	10	12.00 EA
843-4PS	843-4AS	over 4"	6 1/2"	2 5/8"	16	1	4	13.25 EA
PVC STRAINER								
INDIVIDUALLY BAR-CODED BULK								
843-2PP	843-2AP	over 2" or inside 3"	4 1/2"	2 5/8"	–	1	10	10.75 EA
843-3PP	843-3AP	over 3" or inside 4"	5 1/2"	2 1/2"	–	1	10	12.00 EA
843-4PP	843-4AP	over 4"	6 1/2"	2 15/16"	–	1	4	13.25 EA

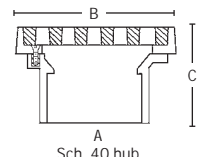

Sch. 40 hub



844-23NR



844-23NQ



844-23i



E option for condensate drain applications

Related Products		
Replacement Strainers		p 181
Grip Tip		p 229

On-Grade Floor Drain Cast Iron No-Hub Connection

Cast Nickel Ring and Strainer

- Extended ring option available for use in condensate drain applications
- For use in pedestrian traffic areas

Square Cast Nickel Ring and Strainer

- Square ring is great for square floor tile
- For use in pedestrian traffic areas

Cast Iron Strainer

- For use in heavy duty application

Options: Add letter suffix. Add prices to list.

V—Vandal-resistant screws* \$5.00

E—Extended ring* \$49.00

*E is only available on 844-24NR

*V is not available on cast iron ring and strainer.

item No.	Dimensions			Min. Qty.	Case Qty.	List Price
	A	B	C			
ROUND NICKEL RING & STRAINER						
INDIVIDUALLY BAR-CODED BULK						
844-22NR	2"	4 1/2"	3 5/16"	1	4	43.75 EA
844-23NR	3"	5 1/2"	3 7/16"	1	4	49.25 EA
844-24NR	4"	6 1/2"	3 9/16"	1	4	65.50 EA
SQUARE NICKEL RING & STRAINER						
INDIVIDUALLY BAR-CODED BULK						
844-22NQ	2"	4 9/16"	2 3/8"	1	1	64.25 EA
844-23NQ	3"	5 11/16"	2 3/8"	1	1	71.25 EA
844-24NQ	4"	7 1/16"	2 3/8"	1	1	80.35 EA
CAST IRON STRAINER						
INDIVIDUALLY BAR-CODED BULK						
844-22i	2"	5"	3 5/16"	1	4	47.50 EA
844-23i	3"	6"	3 7/16"	1	4	50.50 EA
844-24i	4"	6 11/16"	3 9/16"	1	4	54.50 EA

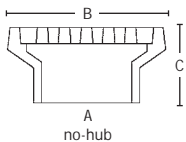

Little Max™ General Purpose Floor Drain

- ABS or PVC solvent weld connection
- Strainer ring can be used as a clamping collar for above-grade applications
- Designed with threaded brass inserts on top side for strainer ring screws, and underneath for use with an underdeck clamp
- Stainless steel lift handle for strainer

Options: Add letter suffix. Add prices to list.

V – Vandal resistant screws	\$8.00
T – Tapped ½" FIP for trap primer	\$8.00
S – Sand bucket installed	\$8.50
2 – Open-half strainer installed	\$12.00
3 – Open-quarter strainer installed	\$14.00
X – Drain body & ring/collar without strainer	–\$5.50

PVC Item No.	ABS Item No.	Dimensions				Min. Qty.	Case Qty.	List Price
		A	B	C	D			
INDIVIDUALLY BAR-CODED BULK								
864-2P	864-2A	2"	7 ¼"	4 ¼"	8 ½"	1	3	35.50 EA
864-3P	864-3A	3"	7 ¼"	4 ¾"	8 ½"	1	3	35.50 EA
864-4P	864-4A	4"	7 ¼"	5 ½"	8 ½"	1	3	35.50 EA
ACCESSORIES								
INDIVIDUALLY BAR-CODED BULK								
864-GP	PVC strainer with lift handle, loose set					1	1	13.50 EA
864-S	PVC sand bucket (fits inside sump area)					1	10	8.50 EA



864-3P



864-S

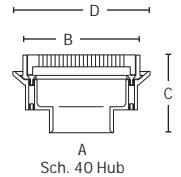

SUPPLY

DRAINAGE

SUPPORT

TESTING

Cast Iron Square Floor Sink

No-Hub Connection

- Porcelain coated cast iron body (ARC)
- High impact resistance
- Perfect for high sanitation or high heat-discharge applications



861-22X



861-AD



861-53i

Item No.	Dimensions					Min. Qty.	Case Qty.	List Price
	A	B	C	D	E			
861-22X	2"	12"	8"	8 ¾"	6 ¼"	1	1	92.00 EA
861-23X	3"	12"	8"	8 ¾"	6 ¼"	1	1	92.00 EA
861-24X	4"	12"	8"	8 ¾"	6 ¼"	1	1	92.00 EA
ACCESSORIES								
861-52i	Open-half grate, porcelain coated cast iron					1	1	19.50 EA
861-53i	Open-quarter grate, porcelain coated cast iron					1	1	19.50 EA
861-5i	Full grate, porcelain coated cast iron					1	1	19.50 EA
861-AD	Dome bottom strainer, aluminum					1	1	13.25 EA

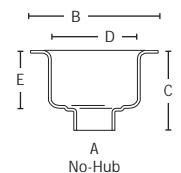

SPECIALTIES

TOOLS

ACCESS

SUPPLY

DRAINAGE

SUPPORT

TESTING

SPECIALTIES

TOOLS

ACCESS



Square Max™ PVC Square Floor Sink

- PVC solvent weld connection
- Sump area is 58% larger than comparable drains
- Low profile design with Slab-Grab flange for a clean finish and a solid installation
- All inner surfaces are pitched, no standing water in sump area
- Independent lab tests show no distortion from water temperatures up to 180°F
- Tough, impact resistant PVC construction
- Three strainer options to fit your application. PVC and cast nickel strainers for pedestrian traffic. Ductile iron strainer for heavy duty applications



Slab-Grab flange provides solid on-grade installations. Strainer rim dimensions work well with square floor tile. 3" Sch. 40 hub also fits inside 4" Sch. 40 pipe.

Item No.	Dimensions				Min. Qty.	Case Qty.	List Price
	A	B	C	D			
DRAIN BODY ONLY							
INDIVIDUALLY BAR-CODED BULK							
861-2PX	2"	11 3/16"	10 11/16"	7 7/16"	1	3	65.00 EA
861-3PX	3 x 4"	11 3/16"	10 11/16"	8 5/16"	1	3	65.00 EA
861-4PX	4"	11 3/16"	10 11/16"	8 7/16"	1	3	67.50 EA
861-6PX	6"	11 3/16"	10 11/16"	9 1/2"	1	3	120.00 EA
PVC STRAINER							
INDIVIDUALLY BAR-CODED BULK							
861-2P	2"	11 3/16"	10 11/16"	7 7/16"	1	1	81.00 EA
861-3P	3 x 4"	11 3/16"	10 11/16"	8 5/16"	1	1	81.00 EA
861-4P	4"	11 3/16"	10 11/16"	8 7/16"	1	1	83.50 EA
861-6P	6"	11 3/16"	10 11/16"	9 1/2"	1	1	136.00 EA
CAST NICKEL RING & STRAINER							
INDIVIDUALLY BAR-CODED BULK							
861-2PN	2"	11 3/4"	10 3/4"	7 3/8"	1	1	387.00 EA
861-3PN	3 x 4"	11 3/4"	10 3/4"	8 3/4"	1	1	387.00 EA
861-4PN	4"	11 3/4"	10 3/4"	8 3/8"	1	1	389.50 EA
861-6PN	6"	11 3/4"	10 3/4"	9 15/16"	1	1	442.00 EA
DUCTILE IRON RING & STRAINER							
INDIVIDUALLY BAR-CODED BULK							
861-2Pi	2"	11 3/4"	10 5/8"	8"	1	1	175.00 EA
861-3Pi	3 x 4"	11 3/4"	10 5/8"	8 3/8"	1	1	175.00 EA
861-4Pi	4"	11 3/4"	10 5/8"	9"	1	1	177.50 EA
861-6Pi	6"	11 3/4"	10 5/8"	10 1/16"	1	1	230.00 EA

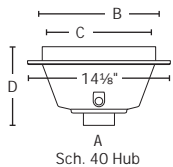

Square Max™ Options

- Square Max options are factory installed on Square Max drains

Suffix Code	Description	Availability Restrictions	Change to List Price
When ordering multiple options, please list suffix code, IN THE ORDER THEY ARE SHOWN BELOW to the appropriate Square Max item number from the previous page			
D	PVC dome bottom strainer Fits into drain outlet: 2½" tall × 5¼" dia.	Not on 6" hub drains	+ 8.00
U	Aluminum dome bottom strainer Fits inside sump area: 2" tall × 4¼" dia.	Not on 6" hub drains	+ 15.00
W	Stainless steel mesh debris bucket Fits inside sump area: 1½" tall × 8¼" dia.	—	+ 85.00
2	Open-half strainer Nickel strainer includes nickel ring	Only for PVC or nickel strainers	- 9.00 PVC - 66.50 Nickel
3	Open-quarter strainer Nickel strainer includes nickel ring	Only for PVC or nickel strainers	- 6.00 PVC - 34.25 Nickel
V	Vandal-resistant screws for strainer	—	+ 8.00
T	Tapped trap primer connection, ½" FIP thread	—	+ 8.00
F	Round nickel condensate funnel with screws 4" tall, 4½" top opening	—	+ 63.25
FA	Round aluminum condensate funnel with screws 4" tall, 4½" top opening	—	+ 30.00
FO	Oval nickel condensate funnel with screws 4" tall, 9⅝" × 3¼" opening	—	+ 85.00
6	PVC flat strainer for drain outlet: 5¼" dia.	Not on 6" hub drains	+ 8.00



Option U
863-U

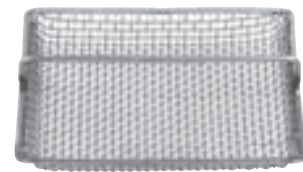

Option W
861-UM



Option 2
861-51

Square Max™ Accessories

- Square Max strainers and accessories are ordered and sold separately

Item No.	Description	Min. Qty.	Case Qty.	List Price
STRAINERS				
861-5	PVC full strainer with lift handle	1	1	26.00 EA
861-51	PVC open-half strainer	1	1	16.00 EA
861-53	PVC open-quarter strainer	1	1	19.50 EA
861-5N	Satin cast nickel full strainer only	1	1	210.00 EA
861-5NR	Satin cast nickel ring & full strainer	1	1	332.00 EA
861-51N	Satin cast nickel open-half strainer only	1	1	142.50 EA
861-51NR	Satin cast nickel ring & open-half strainer	1	1	260.50 EA
861-53N	Satin cast nickel open-quarter strainer only	1	1	173.50 EA
861-53NR	Satin cast nickel ring & open-quarter strainer	1	1	292.75 EA
861-5CiG	Heel-proof, ductile iron strainer only	1	1	70.00 EA
861-5Ci	Heel-proof, ductile iron ring & full strainer	1	1	120.00 EA
ACCESSORIES				
861-D	PVC dome bottom strainer 2½" tall × 5¼" dia. NOT for use on drains with 6" hub connection	1	1	8.00 EA
863-U	Aluminum dome bottom strainer 2" tall × 4¼" dia. NOT for use on drains with 6" hub connection	1	5	15.00 EA
861-6	PVC flat bottom strainer for drain outlet—5¼" dia. NOT for use on drains with 6" hub connection	1	1	8.00 EA
861-UM	Stainless steel debris bucket for sump area 1½" tall × 8¼" dia.	1	1	85.00 EA
863-FA	Aluminum condensate funnel with screws 4" tall, 4½" top opening	1	5	30.00 EA
863-FN	Nickel condensate funnel with screws 4" tall, 4½" top opening	1	5	63.25 EA
863-FNO	Oval nickel condensate funnel with screws	1	5	85.00 EA

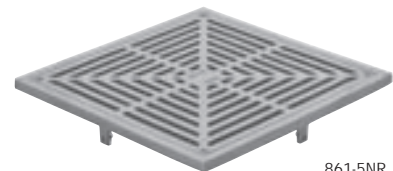

861-5NR



Option FO
863-FNO



Option 6
861-6

SUPPLY

DRAINAGE

SUPPORT

TESTING

SPECIALTIES

TOOLS

ACCESS



Fat Max™ Large Capacity Floor Drain

- ABS or PVC solvent weld connection
- Great for a variety of uses: yard drain, area drain, floor sink, garage drain
- Low profile design with Slab-Grab flange for a clean finish and a solid installation
- Use on grade or with optional clamping collar for above-grade applications



Slab-Grab flange provides solid installations. Perfect for nearly any large capacity application. 3" Sch. 40 hub also fits inside 4" Sch. 40 pipe.

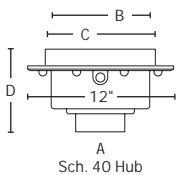

PVC Item No.	ABS Item No.	Dimensions				Min. Qty.	Case Qty.	List Price
		A	B	C	D			
DRAIN BODY ONLY								
INDIVIDUALLY BAR-CODED BULK								
860-2PX	860-2AX	2"	9"	8½"	6¾"	1	4	35.00 EA
860-3PX	860-3AX	3 × 4"	9"	8½"	6¾"	1	4	35.00 EA
860-4PX	860-4AX	4"	9"	8½"	6¾"	1	4	35.00 EA
860-6PX	860-6AX	6"	9"	8½"	8½"	1	1	110.00 EA
ABS OR PVC STRAINER								
INDIVIDUALLY BAR-CODED BULK								
860-2P	860-2A	2"	9"	8½"	6¾"	1	4	55.00 EA
860-3P	860-3A	3 × 4"	9"	8½"	6¾"	1	4	55.00 EA
860-4P	860-4A	4"	9"	8½"	6¾"	1	4	55.00 EA
860-6P	860-6A	6"	9"	8½"	8½"	1	1	130.00 EA
PVC STRAINER, SAND BUCKET INSTALLED								
INDIVIDUALLY BAR-CODED IN A CUT CASE BOX								
860-3PSPK	—	3 × 4"	9"	8½"	6¾"	2	2	65.36 EA
CAST NICKEL RING & STRAINER								
INDIVIDUALLY BAR-CODED BULK								
860-2PN	860-2AN	2"	9¾"	9¾"	7¾"	1	4	246.00 EA
860-3PN	860-3AN	3 × 4"	9¾"	9¾"	7¾"	1	4	246.00 EA
860-4PN	860-4AN	4"	9¾"	9¾"	7¾"	1	4	246.00 EA
860-6PN	860-6AN	6"	9¾"	9¾"	8½"	1	1	321.00 EA
CAST IRON RING & STRAINER								
INDIVIDUALLY BAR-CODED BULK								
860-2Pi	860-2Ai	2"	9¾"	8½"	6¾"	1	2	95.00 EA
860-3Pi	860-3Ai	3 × 4"	9¾"	8½"	6¾"	1	2	95.00 EA
860-4Pi	860-4Ai	4"	9¾"	8½"	6¾"	1	2	95.00 EA
860-6Pi	860-6Ai	6"	9¾"	8½"	8½"	1	1	170.00 EA

Fat Max™ Options

- Fat Max options are factory installed

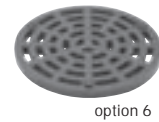
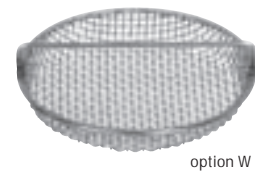
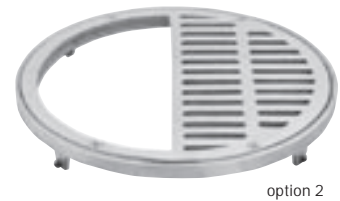

Suffix Code	Description	Availability Restrictions	Change to List Price
When ordering multiple options, please list suffix code, IN THE ORDER THEY ARE SHOWN BELOW to the appropriate Fat Max item number from the previous page			
N	Nickel laminated for cast iron ring & strainer	Only for cast iron strainers	+221.00
S	PVC sand bucket for sump area 3" tall x 7½" dia.	—	+9.00
U	PVC debris bucket for sump area 3" tall x 7½" dia.	—	+8.00
C	PVC clamping collar with eight stainless steel bolts 1 1⁄₁₆" O.D. x 9 1⁄₄" I.D.	—	+10.00
D	PVC dome bottom strainer for drain outlet 2½" tall x 5 1⁄₁₆" dia.	—	+6.00
V	Vandal-resistant screws for strainer	—	+8.00
T	Tapped trap primer connection, ½" FIP thread	—	+8.00
2	Open-half strainer Nickel strainer includes nickel ring	Only for ABS/PVC or nickel strainers	-5.00 plastic -31.00 nickel
3	Open-quarter strainer Nickel strainer includes nickel ring	Only for ABS/PVC or nickel strainers	-2.00 plastic -15.00 nickel
W	Stainless steel mesh debris bucket for sump area 1 1⁄₁₆" tall x 7 3⁄₈" dia.	—	+72.00
F	Round nickel condensate funnel with screws 4" tall, 4 5⁄₁₆" top opening	—	+63.25
FA	Round aluminum condensate funnel with screws 4" tall, 4 5⁄₁₆" top opening	—	+30.00
FO	Oval nickel condensate funnel with screws 4" tall, 9 3⁄₈" x 3 2 1⁄₃₂" opening	—	+85.00
J	Solid PVC cover	Only for 'Drain body only'	+25.00
6	PVC flat strainer for drain outlet 5 1⁄₁₆" dia.	Not on 6" hub drains	+6.00
L	Aluminum dome bottom strainer for drain outlet 2" tall x 4 1 3⁄₁₆" dia.	Not on 6" hub drains	+15.00

SUPPLY

DRAINAGE

SUPPORT

TESTING

SPECIALTIES

TOOLS

ACCESS



860-GP3



860-S



860-D



863-FNO

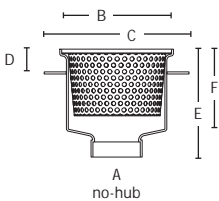

Fat Max[™] Accessories

- Fat Max strainers and accessories are ordered and sold separately

Item No.	Description	Min. Qty.	Case Qty.	List Price
STRAINERS				
860-GP	PVC full strainer with lift handle	1	1	20.00 EA
860-GP2	PVC open-half strainer with lift handle	1	1	15.00 EA
860-GP3	PVC open-quarter strainer with lift handle	1	1	18.00 EA
860-GA	ABS full strainer with lift handle	1	1	20.00 EA
860-GA2	ABS open-half strainer with lift handle	1	1	15.00 EA
860-GA3	ABS open-quarter strainer with lift handle	1	1	18.00 EA
860-GN	Cast nickel full strainer only	1	1	146.00 EA
860-RGN	Cast nickel ring & full strainer	1	1	211.00 EA
860-GN2	Cast nickel open-half strainer only	1	1	101.25 EA
860-RGN2	Cast nickel ring & open-half strainer	1	1	180.00 EA
860-GN3	Cast nickel open-quarter strainer only	1	1	121.00 EA
860-RGN3	Cast nickel ring & open-quarter strainer	1	1	195.50 EA
860-Gi	Cast iron strainer only	1	1	50.00 EA
860-GPJ	PVC full cover	1	1	25.00 EA
ACCESSORIES				
860-S	PVC sand bucket for drain sump area 3" tall × 7¼" dia.	1	1	9.00 EA
860-U	PVC debris bucket for drain sump area 3" tall × 7¼" dia.	1	1	8.00 EA
860-C	PVC clamping collar with stainless steel screws 1 1/16" O.D.	1	1	10.00 EA
860-D	PVC dome bottom strainer (not for 6" hub drains) 2 1/2" tall × 5 1/16" dia.	1	1	6.00 EA
863-U	Aluminum dome bottom strainer (not for 6" hub drains) 2" tall × 4 13/16" dia.	1	5	15.00 EA
860-6	PVC flat bottom strainer (not for 6" hub drains) for drain outlet 5 1/16" dia.	1	10	6.00 EA
860-UM	Stainless steel debris bucket 1 1/8" tall × 7 3/8" dia.	1	1	72.00 EA
863-FA	Aluminum condensate funnel with screws 4" tall, 4 5/16" top opening	1	5	30.00 EA
863-FN	Nickel funnel with screws 4" tall, 4 5/16" top opening	1	5	63.25 EA
863-FNO	Oval nickel funnel with screws 4" tall, 9 1/8" × 3 21/32" opening	1	5	85.00 EA

Fat Max[™] Stainless Steel Large Capacity Floor Drain

- 4" no-hub connection
- 300 Series stainless steel body, strainer and debris bucket
- Perfect for commercial kitchens or other high-sanitation, heavy duty traffic areas
- Smooth-welded inner surfaces with bead blasted finish

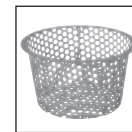

Removable debris bucket included



Item No.	Dimensions						Min. Qty.	Case Qty.	List Price
	A	B	C	D	E	F			
INDIVIDUALLY BAR-CODED BULK									
860-4SS	4"	10"	12 3/4"	2"	9 1/2"	7"	1	1	1,495.00 EA

Finish Line™ Adjustable Flashing Drain

The Finish Line allows for adjustment of the drain AFTER the pour. Achieve a perfect finish for every strainer every time.



Eliminate drains set too high or too low. Stop wrapping threads and boxing out.



Eliminate Finish Fixture damage by keeping them off the job during construction.

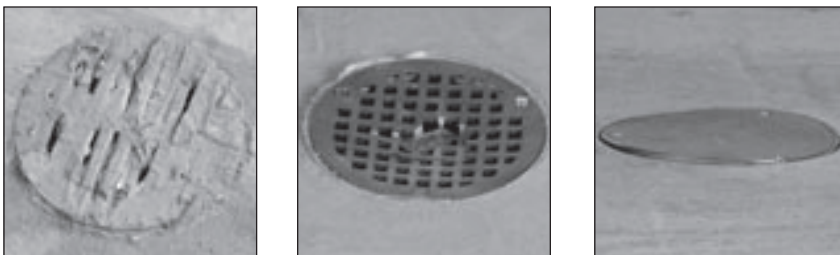

Installing the Finish Line



Set Drain

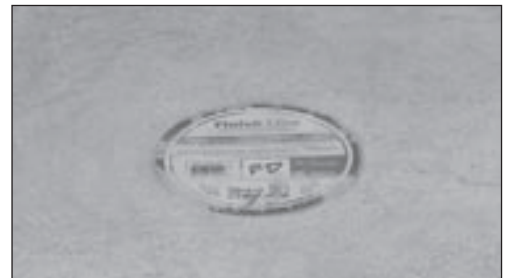

Pour Concrete



Remove Coring Plug



Install Finish Fixture

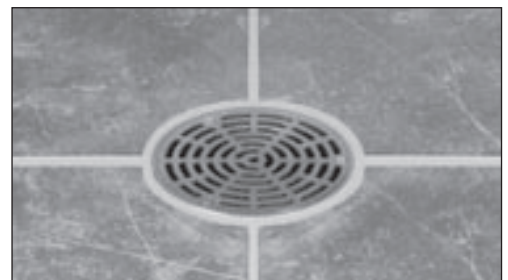

A Perfect Finish

SUPPLY

DRAINAGE

SUPPORT

TESTING

SPECIALTIES

TOOLS

ACCESS

Ductile Iron available
April 2007



833-23DIR



833-63DNQ



832-S4

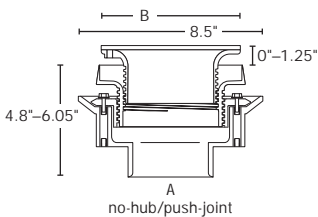

Finish Line™ Adjustable Flashing Drain

Cast Iron No-Hub or Push-Joint Connection

- Ductile on Cast:
Cast iron Base Adapter with ductile iron clamping collar, Coring Sleeve, and Head Adapter. Poly Coring Plug. Neoprene push-joint gasket
- Nickel strainer for use in pedestrian traffic areas.
Ductile iron strainer for use in heavy duty applications



Rough-in Drain is packaged fully assembled with Coring Plug, Coring Sleeve, and Base Adapter.



Finish Fixture is individually boxed and labelled. Order separately.



Complete Assembly is packaged with a fully assembled Rough-in Drain and a separately boxed Finish Fixture.

Options: Add letter suffix. Add prices to list.
V – Vandal-resistant screws \$5.00
E – Extended ring* \$49.00
 *E is only available on Finish Fixtures and Complete Assemblies with round nickel ring and strainer.

Item No.	Ring & Strainer	Dimensions		Min. Qty.	Case Qty.	List Price
		A	B			
NO-HUB ROUGH-IN DRAIN						
833-22DF	–	2"	–	1	1	86.00 EA
833-23DF	–	3"	–	1	1	86.00 EA
833-24DF	–	4"	–	1	1	86.00 EA
PUSH-JOINT ROUGH-IN DRAIN						
833-62DF	–	2"	–	1	1	89.00 EA
833-63DF	–	3"	–	1	1	89.00 EA
833-64DF	–	4"	–	1	1	89.00 EA
FINISH FIXTURE						
832-4DHIR	round ductile	–	6½"	1	1	56.00 EA
832-4DHNR	round nickel	–	6½"	1	1	63.00 EA
832-4DHNO	square nickel	–	7¼"	1	1	79.00 EA
NO-HUB COMPLETE ASSEMBLY						
833-22DIR	round ductile	2"	6½"	1	1	143.00 EA
833-22DNR	round nickel	2"	6½"	1	1	150.00 EA
833-23DIR	round ductile	3"	6½"	1	1	143.00 EA
833-23DNR	round nickel	3"	6½"	1	1	150.00 EA
833-24DIR	round ductile	4"	6½"	1	1	143.00 EA
833-24DNR	round nickel	4"	6½"	1	1	150.00 EA
833-22DNQ	square nickel	2"	7¼"	1	1	166.00 EA
833-23DNQ	square nickel	3"	7¼"	1	1	166.00 EA
833-24DNQ	square nickel	4"	7¼"	1	1	166.00 EA
PUSH-JOINT COMPLETE ASSEMBLY						
833-62DIR	round ductile	2"	6½"	1	1	146.00 EA
833-62DNR	round nickel	2"	6½"	1	1	153.00 EA
833-63DIR	round ductile	3"	6½"	1	1	146.00 EA
833-63DNR	round nickel	3"	6½"	1	1	153.00 EA
833-64DIR	round ductile	4"	6½"	1	1	146.00 EA
833-64DNR	round nickel	4"	6½"	1	1	153.00 EA
833-62DNQ	square nickel	2"	7¼"	1	1	169.00 EA
833-63DNQ	square nickel	3"	7¼"	1	1	169.00 EA
833-64DNQ	square nickel	4"	7¼"	1	1	169.00 EA
ACCESSORIES						
832-S4	Two adjustment shims, two ¾" screws			1	10	9.00 EA

SUPPLY

DRAINAGE

SUPPORT

TESTING

SPECIALTIES

TOOLS

ACCESS

Finish Line™ Adjustable Flashing Drain

Cast Iron No-Hub or Push-Joint Connection

- ABS on Cast:
Cast iron Base Adapter with ABS clamping collar, Coring Sleeve, and Head Adapter. Poly Coring Plug. Neoprene push-joint gasket
- For use in pedestrian traffic areas

Options: Add letter suffix. Add prices to list.

V – Vandal-resistant screws \$5.00
E – Extended ring* \$49.00

*E is only available on Finish Fixtures and Complete Assemblies with round nickel ring and strainer.

Item No.	Ring & Strainer	Dimensions		Min. Qty.	Case Qty.	List Price
		A	B			
NO-HUB ROUGH-IN DRAIN						
833-22F	—	2"	—	1	1	55.00 EA
833-23F	—	3"	—	1	1	55.00 EA
833-24F	—	4"	—	1	1	55.00 EA
PUSH-JOINT ROUGH-IN DRAIN						
833-62F	—	2"	—	1	1	58.00 EA
833-63F	—	3"	—	1	1	58.00 EA
833-64F	—	4"	—	1	1	58.00 EA
FINISH DRAIN FIXTURE						
832-4HNR	round nickel	—	6½"	1	1	47.50 EA
832-4HBR	round brass	—	6½"	1	1	57.50 EA
832-4HNQ	square nickel	—	7¼"	1	1	63.25 EA
832-4HBQ	square brass	—	6¼"	1	1	74.75 EA
NO-HUB COMPLETE ASSEMBLY						
833-22NR	round nickel	2"	6½"	1	1	103.50 EA
833-22BR	round brass	2"	6½"	1	1	113.50 EA
833-23NR	round nickel	3"	6½"	1	1	103.50 EA
833-23BR	round brass	3"	6½"	1	1	113.50 EA
833-24NR	round nickel	4"	6½"	1	1	103.50 EA
833-24BR	round brass	4"	6½"	1	1	113.50 EA
833-22NQ	square nickel	2"	7¼"	1	1	119.25 EA
833-22BQ	square brass	2"	6¼"	1	1	130.75 EA
833-23NQ	square nickel	3"	7¼"	1	1	119.25 EA
833-23BQ	square brass	3"	6¼"	1	1	130.75 EA
833-24NQ	square nickel	4"	7¼"	1	1	119.25 EA
833-24BQ	square brass	4"	6¼"	1	1	130.50 EA
PUSH-JOINT COMPLETE ASSEMBLY						
833-62NR	round nickel	2"	6½"	1	1	106.50 EA
833-62BR	round brass	2"	6½"	1	1	116.50 EA
833-63NR	round nickel	3"	6½"	1	1	106.50 EA
833-63BR	round brass	3"	6½"	1	1	116.50 EA
833-64NR	round nickel	4"	6½"	1	1	106.50 EA
833-64BR	round brass	4"	6½"	1	1	116.50 EA
833-62NQ	square nickel	2"	7¼"	1	1	122.25 EA
833-62BQ	square brass	2"	6¼"	1	1	133.75 EA
833-63NQ	square nickel	3"	7¼"	1	1	122.25 EA
833-63BQ	square brass	3"	6¼"	1	1	133.75 EA
833-64NQ	square nickel	4"	7¼"	1	1	122.25 EA
833-64BQ	square brass	4"	6¼"	1	1	133.75 EA
ACCESSORIES						
832-S4	Two adjustment shims, two ¾" screws			1	10	9.00 EA



833-23NR



833-63BR



832-S4

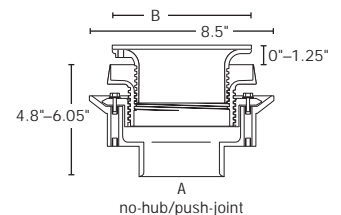

SUPPLY

DRAINAGE

SUPPORT

TESTING

SPECIALTIES

TOOLS

ACCESS

Finish Line™ Adjustable Flashing Drain

Sch. 40 Hub Connection

- Adjustable AFTER the pour
- ABS/PVC Base Adapter with ABS clamping collar, Coring Sleeve, and Head Adapter. Poly Coring Plug
- For use in pedestrian traffic areas



833-3PNR



833-3PNQ



Rough-in Drain is packaged fully assembled with Coring Plug, Coring Sleeve, and Base Adapter.



Finish Fixture is individually boxed and labelled. Order separately.



Complete Assembly is packaged with a fully assembled Rough-in Drain and a separately boxed Finish Fixture.

Options: Add letter suffix. Add prices to list.

V – Vandal-resistant screws \$5.00

E – Extended ring* \$49.00

*E is only available on Finish Fixtures and Complete Assemblies with round nickel ring and strainer.



832-S4

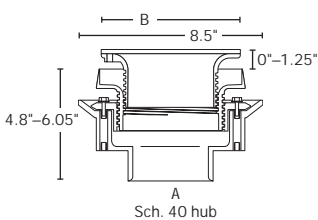

A Sch. 40 hub



PVC Item No.	ABS Item No.	Ring & Strainer	Dimensions		Min. Qty.	Case Qty.	List Price
			A	B			
ROUGH-IN DRAIN							
833-2PF	833-2AF	–	2"	–	1	1	35.50 EA
833-3PF	833-3AF	–	3"	–	1	1	35.50 EA
833-4PF	833-4AF	–	4"	–	1	1	35.50 EA
FINISH FIXTURE							
832-4HNR		round nickel	–	6½"	1	1	47.50 EA
832-4HBR		round brass	–	6½"	1	1	57.50 EA
832-4HNO		square nickel	–	7¼"	1	1	63.25 EA
832-4HBO		square brass	–	6¾"	1	1	74.75 EA
COMPLETE ASSEMBLY							
833-2PNR	833-2ANR	round nickel	2"	6½"	1	1	84.00 EA
833-2PBR	833-2ABR	round brass	2"	6½"	1	1	94.00 EA
833-3PNR	833-3ANR	round nickel	3"	6½"	1	1	84.00 EA
833-3PBR	833-3ABR	round brass	3"	6½"	1	1	94.00 EA
833-4PNR	833-4ANR	round nickel	4"	6½"	1	1	84.00 EA
833-4PBR	833-4ABR	round brass	4"	6½"	1	1	94.00 EA
833-2PNQ	833-2ANQ	square nickel	2"	7¼"	1	1	99.75 EA
833-2PBQ	833-2ABQ	square brass	2"	6¾"	1	1	111.25 EA
833-3PNQ	833-3ANQ	square nickel	3"	7¼"	1	1	99.75 EA
833-3PBQ	833-3ABQ	square brass	3"	6¾"	1	1	111.25 EA
833-4PNQ	833-4ANQ	square nickel	4"	7¼"	1	1	99.75 EA
833-4PBQ	833-4ABQ	square brass	4"	6¾"	1	1	111.25 EA
ACCESSORIES							
832-S4	Two adjustment shims, two ¾" screws		1	10	1	10	9.00 EA

Flashing Drain Sch. 40 Hub Connection

Cast Metal Ring and Strainer

- ABS/PVC base adapter with PVC clamping collar and head adapter
- Brass female thread inserts accept all screws
- Can be used with an underdeck clamp
- For use in pedestrian traffic areas

Cast Iron Ring and Strainer

- ABS/PVC base adapter with PVC clamping collar and head adapter
- Brass female thread inserts accept all screws
- Can be used with an underdeck clamp
- For use in heavy duty applications



E option for use in condensate drain applications

Related Products

Replacement strainers p 181
Grip Tip p 229

Options: Add letter suffix. Add prices to list

- V – Vandal-resistant screws* \$5.00
- T – Tapped 1/2" FIP for trap primer with plug \$6.00
- Y – Cast iron top housing in lieu of PVC \$35.00
- D – Ductile iron flashing collar in lieu of PVC \$12.00
- E – Extended ring* \$49.00

*V and E are not available on cast iron strainers
*E is only available on 6 1/2" ring ('B' Dimension).



863-435NR



863-435i

PVC Item No.	ABS Item No.	Dimensions			Min. Qty.	Case Qty.	List Price
		A	B	C			
NICKEL RING AND STRAINER							
INDIVIDUALLY BAR-CODED BULK							
863-425NR	863-325NR	2"	5 1/2"	4 1/2"–6 3/8"	1	6	59.50 EA
863-42NR	863-32NR	2"	6 1/2"	4 3/4"–6 5/8"	1	6	69.75 EA
863-435NR	863-335NR	3"	5 1/2"	4 1/2"–6 3/8"	1	6	59.50 EA
863-43NR	863-33NR	3"	6 1/2"	4 3/4"–6 5/8"	1	6	69.75 EA
863-445NR	863-345NR	4"	5 1/2"	4 1/2"–6 3/8"	1	6	59.50 EA
863-44NR	863-34NR	4"	6 1/2"	4 3/4"–6 5/8"	1	6	69.75 EA
BRASS RING AND STRAINER							
INDIVIDUALLY BAR-CODED BULK							
863-425BR	863-325BR	2"	5 1/2"	4 1/2"–6 3/8"	1	3	71.75 EA
863-42BR	863-32BR	2"	6 1/2"	4 3/4"–6 5/8"	1	3	83.25 EA
863-435BR	863-335BR	3"	5 1/2"	4 1/2"–6 3/8"	1	2	71.75 EA
863-43BR	863-33BR	3"	6 1/2"	4 3/4"–6 5/8"	1	2	83.25 EA
863-445BR	863-345BR	4"	5 1/2"	4 1/2"–6 3/8"	1	2	71.75 EA
863-44BR	863-34BR	4"	6 1/2"	4 3/4"–6 5/8"	1	2	83.25 EA
CAST IRON RING AND STRAINER							
INDIVIDUALLY BAR-CODED BULK							
863-425i	863-325i	2"	6 1/16"	4 15/16"–6 13/16"	1	2	61.00 EA
863-42i	863-32i	2"	6 11/16"	5 3/8"–7 1/4"	1	2	66.75 EA
863-435i	863-335i	3"	6 1/16"	4 15/16"–6 13/16"	1	2	61.00 EA
863-43i	863-33i	3"	6 11/16"	5 3/8"–7 1/4"	1	2	66.75 EA
863-445i	863-345i	4"	6 1/16"	4 15/16"–6 13/16"	1	2	61.00 EA
863-44i	863-34i	4"	6 11/16"	5 3/8"–7 1/4"	1	2	66.75 EA

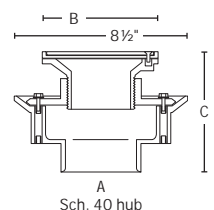

A Sch. 40 hub

Flashing Drain Sch. 40 Hub Connection

Square Cast Metal Ring and Strainer

- ABS/PVC base adapter with PVC clamping collar and head adapter
- Brass female thread inserts accept all screws
- Can be used with an underdeck clamp
- For use in pedestrian traffic areas



863-445NQ



863-445P

PVC Strainer

- ABS/PVC base adapter with PVC clamping collar and head adapter
- Brass female thread inserts accept all screws
- Can be used with an underdeck clamp
- For use in pedestrian traffic areas

Related Products	
Replacement strainers	p 181
Grip Tip	p 229

- Options:** Add letter suffix. Add prices to list
- V**—Vandal-resistant screws \$5.00
 - T**—Tapped ½" FIP for trap primer with plug \$6.00
 - Y**—Cast iron head adapter in lieu of PVC* \$35.00
 - D**—Ductile iron clamping collar in lieu of PVC \$12.00
- *Y is not available with PVC strainer.

PVC Item No.	ABS Item No.	Dimensions			Min. Qty.	Case Qty.	List Price
		A	B	C			
SQUARE NICKEL RING AND STRAINER							
INDIVIDUALLY BAR-CODED BULK							
863-425NQ	863-325NQ	2"	5 ¹¹ / ₁₆ "	4 ¹ / ₂ " – 6 ³ / ₈ "	1	2	78.00 EA
863-42NQ	863-32NQ	2"	7 ¹ / ₁₆ "	4 ³ / ₄ " – 6 ⁵ / ₈ "	1	2	88.35 EA
863-435NQ	863-335NQ	3"	5 ¹¹ / ₁₆ "	4 ¹ / ₂ " – 6 ³ / ₈ "	1	2	78.00 EA
863-43NQ	863-33NQ	3"	7 ¹ / ₁₆ "	4 ³ / ₄ " – 6 ⁵ / ₈ "	1	2	88.35 EA
863-445NQ	863-345NQ	4"	5 ¹¹ / ₁₆ "	4 ¹ / ₂ " – 6 ³ / ₈ "	1	2	78.00 EA
863-44NQ	863-34NQ	4"	7 ¹ / ₁₆ "	4 ³ / ₄ " – 6 ⁵ / ₈ "	1	2	88.35 EA
SQUARE BRASS RING AND STRAINER							
INDIVIDUALLY BAR-CODED BULK							
863-425BQ	863-325BQ	2"	5 ¹¹ / ₁₆ "	4 ¹ / ₂ " – 6 ³ / ₈ "	1	2	90.75 EA
863-42BQ	863-32BQ	2"	6 ¹¹ / ₁₆ "	4 ³ / ₄ " – 6 ⁵ / ₈ "	1	2	99.85 EA
863-435BQ	863-335BQ	3"	5 ¹¹ / ₁₆ "	4 ¹ / ₂ " – 6 ³ / ₈ "	1	2	90.75 EA
863-43BQ	863-33BQ	3"	6 ¹¹ / ₁₆ "	4 ³ / ₄ " – 6 ⁵ / ₈ "	1	2	99.85 EA
863-445BQ	863-345BQ	4"	5 ¹¹ / ₁₆ "	4 ¹ / ₂ " – 6 ³ / ₈ "	1	2	90.75 EA
863-44BQ	863-34BQ	4"	6 ¹¹ / ₁₆ "	4 ³ / ₄ " – 6 ⁵ / ₈ "	1	2	99.85 EA
PVC STRAINER							
INDIVIDUALLY BAR-CODED BULK							
863-425P	863-325P	2"	5 ¹ / ₂ "	4 ¹ / ₂ " – 6 ³ / ₈ "	1	3	35.00 EA
863-42P	863-32P	2"	6 ¹ / ₂ "	4 ³ / ₈ " – 6 ³ / ₄ "	1	3	37.00 EA
863-435P	863-335P	3"	5 ¹ / ₂ "	4 ¹ / ₂ " – 6 ³ / ₈ "	1	2	35.00 EA
863-43P	863-33P	3"	6 ¹ / ₂ "	4 ³ / ₈ " – 6 ³ / ₄ "	1	2	37.00 EA
863-445P	863-345P	4"	5 ¹ / ₂ "	4 ¹ / ₂ " – 6 ³ / ₈ "	1	2	35.00 EA
863-44P	863-34P	4"	6 ¹ / ₂ "	4 ³ / ₈ " – 6 ³ / ₄ "	1	2	37.00 EA

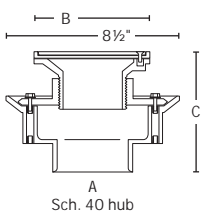

SUPPLY

DRAINAGE

SUPPORT

TESTING

SPECIALTIES

TOOLS

ACCESS

Flashing Drain Cast Iron No-Hub Connection

Round Nickel Ring and Strainer

- Cast iron base adapter with PVC clamping collar and head adapter
- Tapped and plugged trap primer connection
- For use in pedestrian traffic areas

Square Nickel Ring and Strainer

- Cast iron base adapter with PVC clamping collar and head adapter
- Tapped and plugged trap primer connection
- For use in pedestrian traffic areas

Cast Iron Ring and Strainer

- Cast iron base adapter with PVC clamping collar and head adapter
- Tapped and plugged trap primer connection
- For use in heavy duty applications



863-23NR



863-23NQ



863-23i

Related Products	
Replacement strainers	p 181
Grip Tip	p 229

Options: Add letter suffix. Add prices to list

- V** – Vandal-resistant screws* \$5.00
- Y** – Cast iron head adapter in lieu of PVC \$35.00
- D** – Ductile iron clamping collar in lieu of PVC \$12.00
- E** – Extended Ring* \$49.00

***V** and **E** are not available on cast iron ring and strainer.

***E** is only available on round 6½" ring ('B' Dimension).

Item No.	Dimensions			Min. Qty.	Case Qty.	List Price
	A	B	C			
ROUND NICKEL RING AND STRAINER						
INDIVIDUALLY BAR-CODED BULK						
863-22NR	2"	6½"	4¾" – 6⅝"	1	3	92.75 EA
863-23NR	3"	6½"	4¾" – 6⅝"	1	2	92.75 EA
863-24NR	4"	6½"	4¾" – 6⅝"	1	2	92.75 EA
SQUARE NICKEL RING AND STRAINER						
INDIVIDUALLY BAR-CODED BULK						
863-22NQ	2"	7⅛"	4¾" – 6⅝"	1	2	107.85 EA
863-23NQ	3"	7⅛"	4¾" – 6⅝"	1	2	107.85 EA
863-24NQ	4"	7⅛"	4¾" – 6⅝"	1	2	107.85 EA
CAST IRON RING AND STRAINER						
INDIVIDUALLY BAR-CODED BULK						
863-22i	2"	6⅛"	5⅜" – 7¼"	1	2	86.25 EA
863-23i	3"	6⅛"	5⅜" – 7¼"	1	2	86.25 EA
863-24i	4"	6⅛"	5⅜" – 7¼"	1	2	86.25 EA

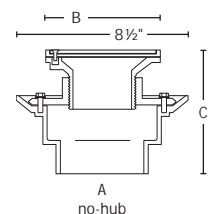



863-63NR



863-63NQ



863-63i

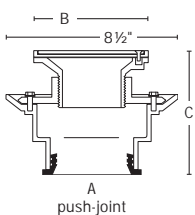

Flashing Drain Cast Iron Push-Joint Connection

Round Nickel Ring and Strainer

- Cast iron base adapter with PVC clamping collar and head adapter. Neoprene push-joint gasket
- Tapped and plugged trap primer connection
- For use in pedestrian traffic areas

Square Nickel Ring and Strainer

- Cast iron base adapter with PVC clamping collar and head adapter. Neoprene push-joint gasket
- Tapped and plugged trap primer connection
- For use in pedestrian traffic areas

Cast Iron Ring and Strainer

- Cast iron base adapter with PVC clamping collar and head adapter. Neoprene push-joint gasket
- Tapped and plugged trap primer connection
- For use in heavy duty applications

Related Products

Replacement strainers	p 181
Grip Tip	p 229

Options: Add letter suffix. Add prices to list

V – Vandal-resistant screws*	\$5.00
Y – Cast iron head adapter in lieu of PVC	\$35.00
D – Ductile iron clamping collar in lieu of PVC	\$12.00
E – Extended Ring*	\$49.00

*V and E are not available on cast iron ring and strainer.

*E is only available on round 6 1/2" ring ('B' Dimension).

Item No.	Dimensions			Min. Qty.	Case Qty.	List Price
	A	B	C			
ROUND NICKEL RING AND STRAINER						
INDIVIDUALLY BAR-CODED BULK						
863-62NR	2"	6 1/2"	5" – 6 3/8"	1	3	95.75 EA
863-63NR	3"	6 1/2"	5" – 6 3/8"	1	2	95.75 EA
863-64NR	4"	6 1/2"	5" – 6 3/8"	1	2	95.75 EA
SQUARE NICKEL RING AND STRAINER						
INDIVIDUALLY BAR-CODED BULK						
863-62NQ	2"	7 1/16"	5" – 6 3/8"	1	2	110.85 EA
863-63NQ	3"	7 1/16"	5" – 6 3/8"	1	2	110.85 EA
863-64NQ	4"	7 1/16"	5" – 6 3/8"	1	2	110.85 EA
CAST IRON RING AND STRAINER						
INDIVIDUALLY BAR-CODED BULK						
863-62i	2"	6 11/16"	5 5/8" – 7 1/2"	1	2	89.25 EA
863-63i	3"	6 11/16"	5 5/8" – 7 1/2"	1	2	89.25 EA
863-64i	4"	6 11/16"	5 5/8" – 7 1/2"	1	2	89.25 EA



867 Series Solvent Weld Roof Drain

Polypropylene or Cast Iron Strainer

- ABS or PVC solvent weld connection
- Uses "key and keyhole" alignment system on dome and gravel guard
- Polypro dome strainer and PVC gravel guard are U.V. resistant
- Brass female thread inserts accept screws



867-P3



867-C

Related Products	
Replacement Strainers	p 183
Grip Tip	p 229

Options: Add letter suffix. Add prices to list.

- V** – Vandal-resistant screws \$5.00
- P** – Steel micro-screen installed over dome strainer \$45.00
- C** – Ductile iron gravel guard in lieu of PVC \$12.00
- STP2** – 2" overflow standpipe installed \$25.00
- U** – Underdeck clamp kit \$26.00

PVC Item No.	ABS Item No.	Connection	Min. Qty.	Case Qty.	List Price
POLYPROPYLENE DOME STRAINER					
INDIVIDUALLY BAR-CODED BULK					
867-P2	867-A2	2" Sch. 40 hub	1	2	33.50 EA
867-P3	867-A3	3" Sch. 40 hub	1	2	33.50 EA
867-P4	867-A4	4" Sch. 40 hub	1	2	33.50 EA
EPOXY COATED CAST IRON DOME STRAINER					
INDIVIDUALLY BAR-CODED BULK					
867-P2M	867-A2M	2" Sch. 40 hub	1	2	58.50 EA
867-P3M	867-A3M	3" Sch. 40 hub	1	2	58.50 EA
867-P4M	867-A4M	4" Sch. 40 hub	1	2	58.50 EA
ACCESSORIES					
867-C	Underdeck clamp kit : four pieces 8" thread rod, four washers, four nuts and two 14" clamping bars		1	25	26.00 EA
867-HC	PVC replacement gravel guard		1	5	11.00 EA
867-MC	Ductile iron replacement gravel guard		1	5	20.00 EA

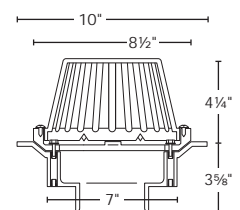

868 Series Solvent Weld Roof Drain

Polyethylene or Cast Aluminum Strainer

- ABS or PVC solvent weld connection
- Polyethylene dome strainer is U.V. resistant
- Cast aluminum dome strainer and gravel guard are epoxy coated
- Brass female thread inserts accept screws



868-P4

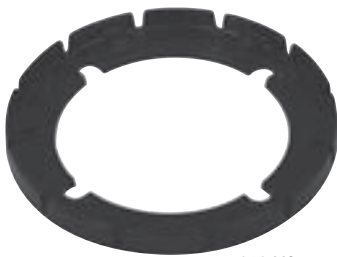

868-MC



868-E



868-S

Related Products
Replacement Strainers p 183

Options: Add letter suffix. Add prices to list.

- V** – Vandal-resistant screws \$5.00
- P** – Steel micro-screen installed over dome strainer \$45.00
- STP2** – 2" overflow standpipe installed* \$25.00
- U** – Underdeck clamp kit* \$45.00
- U8** – Underdeck clamp kit for 8" drain \$57.00
- S** – Sump receiver* \$40.00
- E** – Extension collar kit* \$45.00

*Not available on the 8" drain.

PVC Item No.	ABS Item No.	Dimensions					Min. Qty.	Case Qty.	List Price
		A	B	C	D	E			
POLYETHYLENE DOME STRAINER									
INDIVIDUALLY BAR-CODED BULK									
868-P3	868-A3	3" hub	11"	5"	3¼"	8¾"	1	2	80.00 EA
868-P4	868-A4	4" hub	11"	5"	3¼"	8¾"	1	2	80.00 EA
868-P6	868-A6	6" hub	11"	5"	3¼"	8¾"	1	2	80.00 EA
868-P8	—	8" spigot	16"	4¼"	6¾"	14½"	1	2	100.00 EA
EPOXY COATED CAST ALUMINUM DOME STRAINER									
INDIVIDUALLY BAR-CODED BULK									
868-P3M	868-A3M	3" hub	11"	5"	3¼"	8¾"	1	2	115.00 EA
868-P4M	868-A4M	4" hub	11"	5"	3¼"	8¾"	1	2	115.00 EA
868-P6M	868-A6M	6" hub	11"	5"	3¼"	8¾"	1	2	115.00 EA
ACCESSORIES									
868-MC	Epoxy coated aluminum replacement gravel guard						1	10	40.00 EA
868-C	Under deck clamp kit for 3"–6" roof drains: 11" epoxy coated clamping plate, thread rod, nuts & washers						1	5	45.00 EA
868-C8	Under deck clamp kit for 8" roof drain: 16" epoxy coated clamping plate, thread rod, nuts & washers						1	5	57.00 EA
867-C	Two-piece under deck clamp kit for 3"–6" roof drains: four pieces 8" thread rod, four washers, four nuts and two 14" clamping bars						1	25	26.00 EA
868-E	Extension collar kit for 3"–6" roof drains: 13" epoxy coated extension collar, thread rod, nuts & washers						1	5	45.00 EA
868-S	Sump receiver for 3"–6" roof drains: 11½" epoxy coated sump receiver plate						1	10	40.00 EA

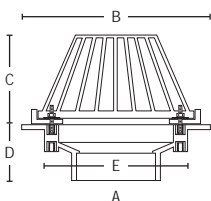

SUPPLY

DRAINAGE

SUPPORT

TESTING

SPECIALTIES

TOOLS

ACCESS

868 Series No-Hub Roof Drain

Polyethylene or Cast Aluminum Strainer

- Cast iron no-hub connection
- Polyethylene dome strainer is U.V. resistant
- Cast aluminum dome strainer and gravel guard are epoxy coated



868-i4



868-MC



868-E



868-S

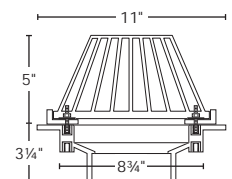

Related Products
Replacement Strainers p 183

Options: Add letter suffix. Add prices to list.

- V**–Vandal-resistant screws \$5.00
- P**–Steel micro-screen installed over dome strainer \$45.00
- STP2**–2" overflow standpipe installed \$25.00
- U**–Underdeck clamp kit \$45.00
- S**–Sump receiver \$40.00
- E**–Extension collar kit \$45.00

Item No.	Connection	Min. Qty.	Case Qty.	List Price
POLYETHYLENE DOME STRAINER				
INDIVIDUALLY BAR-CODED BULK				
868-i3	3" no-hub	1	2	100.00 EA
868-i4	4" no-hub	1	2	100.00 EA
868-i6	6" no-hub	1	2	130.00 EA
EPOXY COATED CAST ALUMINUM DOME STRAINER				
INDIVIDUALLY BAR-CODED BULK				
868-i3M	3" no-hub	1	2	135.00 EA
868-i4M	4" no-hub	1	2	135.00 EA
868-i6M	6" no-hub	1	2	165.00 EA
ACCESSORIES				
868-MC	Epoxy coated aluminum replacement gravel guard	1	10	40.00 EA
868-C	Under deck clamp kit: 11" epoxy coated clamping plate, thread rod, nuts & washers	1	5	45.00 EA
867-C	Two-piece underdeck clamp kit: four pieces 8" thread rod, four washers, four nuts and two 14" clamping bars	1	25	26.00 EA
868-E	Extension collar kit: 13" epoxy coated extension collar, thread rod, nuts & washers	1	5	45.00 EA
868-S	Sump receiver: 11 1/2" epoxy coated sump receiver plate	1	10	40.00 EA



Finish Line™ Adjustable Cleanout

The Finish Line allows for adjustment of the cleanout AFTER the pour. Achieve a perfect finish for every cover, every time.



Eliminate drains set too high or too low.
Stop wrapping threads and boxing out.



Eliminate Finish Fixture damage
by keeping them off the job during construction.

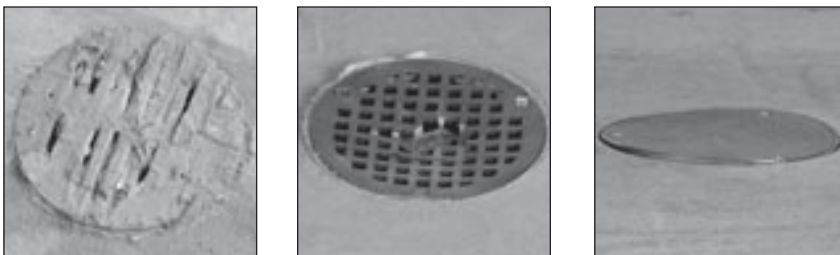

Installing the Finish Line



Set Drain



Pour Concrete



Remove Coring Plug



Install Finish Fixture

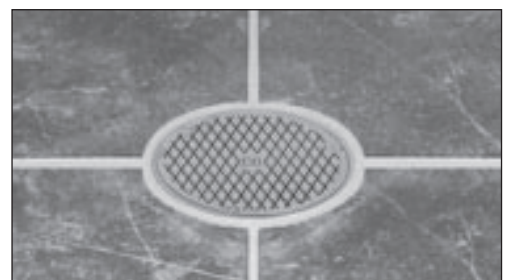

A Perfect Finish

SUPPLY

DRAINAGE

SUPPORT

TESTING

SPECIALTIES

TOOLS

ACCESS

Ductile Iron available
April 2007



834-3DiR



834-4DNO

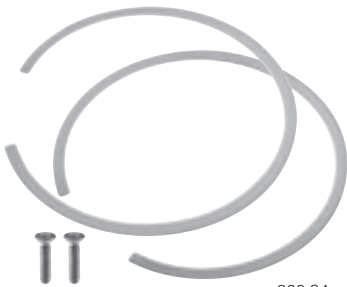

832-S4

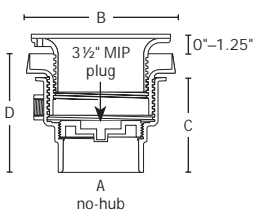

Finish Line™ Adjustable Cleanout

Ductile Iron No-Hub Connection

- Adjustable AFTER the pour
- Ductile iron Base Adapter with polypro cleanout plug. Ductile iron Coring Sleeve, and Head Adapter. Poly Coring Plug
- Nickel covers for use in pedestrian areas. Ductile iron covers for use in heavy duty applications



Rough-in Cleanout is packaged fully assembled with Coring Plug, Coring Sleeve, and Base Adapter with cleanout plug.

Finish Fixture is individually boxed and labeled. Order separately.

Complete Assembly is packaged with a fully assembled Rough-in Cleanout and a separately boxed Finish Fixture.

Options: Add letter suffix. Add prices to list.

V – Vandal-resistant screws \$5.00

S – Stamping: specify ST or SAN* \$5.00

*S not available on ductile iron covers.

Item No.	Ring & Cover	Dimensions				Min. Qty.	Case Qty.	List Price
		A	B	C	D			
ROUGH-IN CLEANOUT								
834-3DF	–	3"	–	4.4"	5.3"–6.55"	1	1	40.00 EA
834-4DF	–	4"	–	4.6"	5.5"–6.75"	1	1	43.00 EA
FINISH FIXTURE								
834-4DHIR	round ductile	–	6 1/2"	–	–	1	1	56.00 EA
834-4DHNR	round nickel	–	6 1/2"	–	–	1	1	73.00 EA
834-4DHNQ	square nickel	–	6 11/16"	–	–	1	1	93.00 EA
COMPLETE ASSEMBLY								
834-3DiR	round ductile	3"	6 1/2"	4.4"	5.3"–6.55"	1	1	97.00 EA
834-3DNR	round nickel	3"	6 1/2"	4.4"	5.3"–6.55"	1	1	114.00 EA
834-3DNQ	square nickel	3"	6 11/16"	4.4"	5.5"–6.75"	1	1	134.00 EA
834-4DiR	round ductile	4"	6 1/2"	4.6"	5.5"–6.75"	1	1	100.00 EA
834-4DNR	round nickel	4"	6 1/2"	4.6"	5.3"–6.55"	1	1	117.00 EA
834-4DNO	square nickel	4"	6 11/16"	4.6"	5.3"–6.55"	1	1	137.00 EA
ACCESSORIES								
832-S4	Two adjustment shims, two 3/4" screws					1	10	9.00 EA



SUPPLY

DRAINAGE

SUPPORT

TESTING

SPECIALTIES

TOOLS

ACCESS

Finish Line™ Adjustable Cleanout

Sch. 40 Hub Connection

- Adjustable AFTER the pour
- ABS/PVC Base Adapter with polypro cleanout plug, ABS Coring Sleeve and Head Adapter. Poly Coring Plug
- For use in pedestrian traffic areas



Rough-in Cleanout is packaged fully assembled with Coring Plug, Coring Sleeve, and Base Adapter with cleanout plug.



Finish Fixture is individually boxed and labeled. Order separately.



Complete Assembly is packaged with a fully assembled Rough-in Cleanout and a separately boxed Finish Fixture.

Options: Add letter suffix. Add prices to list.
V – Vandal-resistant screws \$5.00
S – Stamping: specify ST or SAN \$5.00



834-3ANR



834-4PNQ



832-S4

PVC Item No.	ABS Item No.	Ring & Cover	Dimensions				Min. Qty.	Case Qty.	List Price
			A	B	C	D			
ROUGH-IN CLEANOUT									
834-3PF	834-3AF	—	3"	—	4.4"	5.3"–6.55"	1	1	21.75 EA
834-4PF	834-4AF	—	4"	—	4.6"	5.5"–6.75"	1	10	22.75 EA
FINISH FIXTURE									
834-4HNR		round nickel	—	6½"	—	—	1	1	50.25 EA
834-4HBR		round brass	—	6½"	—	—	1	1	67.75 EA
834-4HTR		round tenz	—	6½"	—	—	1	1	35.25 EA
834-4HNO		square nickel	—	6⅞"	—	—	1	1	79.25 EA
834-4HBO		square brass	—	6⅞"	—	—	1	1	89.25 EA
834-4HTO		square tenz	—	6⅞"	—	—	1	1	47.75 EA
COMPLETE ASSEMBLY									
834-3PNR	834-3ANR	round nickel	3"	6½"	4.4"	5.3"–6.55"	1	1	73.00 EA
834-3PBR	834-3ABR	round brass	3"	6½"	4.4"	5.3"–6.55"	1	1	90.50 EA
834-3PTR	834-3ATR	round tenz	3"	6½"	4.4"	5.3"–6.55"	1	1	58.00 EA
834-4PNR	834-4ANR	round nickel	4"	6½"	4.6"	5.5"–6.75"	1	1	74.00 EA
834-4PBR	834-4ABR	round brass	4"	6½"	4.6"	5.5"–6.75"	1	1	91.50 EA
834-4PTR	834-4ATR	round tenz	4"	6½"	4.6"	5.5"–6.75"	1	1	59.00 EA
834-3PNQ	834-3ANQ	square nickel	3"	6⅞"	4.4"	5.3"–6.55"	1	1	102.00 EA
834-3PBQ	834-3ABQ	square brass	3"	6⅞"	4.4"	5.3"–6.55"	1	1	112.50 EA
834-3PTQ	834-3ATQ	square tenz	3"	6⅞"	4.4"	5.3"–6.55"	1	1	70.50 EA
834-4PNQ	834-4ANQ	square nickel	4"	6⅞"	4.6"	5.5"–6.75"	1	1	103.00 EA
834-4PBQ	834-4ABQ	square brass	4"	6⅞"	4.6"	5.5"–6.75"	1	1	113.00 EA
834-4PTQ	834-4ATQ	square tenz	4"	6⅞"	4.6"	5.5"–6.75"	1	1	71.50 EA
ACCESSORIES									
832-S4	Two adjustment shims, two ¾" screws						1	10	9.00 EA

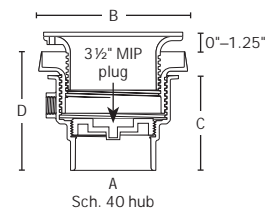

Adjustable Cleanout PVC MIP Thread

Round Cast Metal Ring and Cover

- Polypro plug included
- Brass female thread inserts accept cover screws
- MIP thread top housing adapts to any FIP adapter
- For use in pedestrian traffic areas



852-3PNR



852-3LNR

SUPPLY

DRAINAGE

SUPPORT

TESTING

SPECIALTIES

TOOLS

ACCESS

Related Products	
Replacement covers	p 184
Available adapters	p 178-180

Options: Add letter suffix. Add prices to list.
V—Vandal-resistant screws \$5.00
S—Stamped cover: specify ST or SAN \$5.00
9—Fitting socket ring* —\$0.75
 *9 only applies to series with adapter.

PVC Item No.	ABS Item No.	Ring & Strainer	Dimensions				Min. Qty.	Case Qty.	List Price
			A	B	C	D			
WITH ADAPTER									
INDIVIDUALLY BAR-CODED BULK									
852-2PNR	852-2ANR	nickel	2" hub	4 1/2"	3 5/8"–5"	1 1/2"	1	5	42.75 EA
852-3PNR	852-3ANR	nickel	3" hub	5 1/2"	4 1/4"–5 1/2"	2 1/2"	1	5	53.50 EA
852-4PNR	852-4ANR	nickel	4" hub	6 1/2"	4 1/2"–5 3/4"	3 1/2"	1	10	60.00 EA
852-2PBR	852-2ABR	brass	2" hub	4 1/2"	3 5/8"–5"	1 1/2"	1	5	44.75 EA
852-3PBR	852-3ABR	brass	3" hub	5 1/2"	4 1/4"–5 1/2"	2 1/2"	1	5	61.25 EA
852-4PBR	852-4ABR	brass	4" hub	6 1/2"	4 1/2"–5 3/4"	3 1/2"	1	10	80.50 EA
852-3PTR	852-3ATR	tenz	3" hub	5 1/2"	4 1/4"–5 1/2"	2 1/2"	1	5	38.25 EA
852-4PTR	852-4ATR	tenz	4" hub	6 1/2"	4 1/2"–5 3/4"	3 1/2"	1	10	49.00 EA
NO ADAPTER									
INDIVIDUALLY BAR-CODED BULK									
	852-2LNR	nickel	2" MIP	4 1/2"	—	1 1/2"	1	10	39.25 EA
	852-3LNR	nickel	3" MIP	5 1/2"	—	2 1/2"	1	10	47.50 EA
	852-4LNR	nickel	4" MIP	6 1/2"	—	3 1/2"	1	10	55.25 EA
	852-2LBR	brass	2" MIP	4 1/2"	—	1 1/2"	1	10	41.25 EA
	852-3LBR	brass	3" MIP	5 1/2"	—	2 1/2"	1	10	55.25 EA
	852-4LBR	brass	4" MIP	6 1/2"	—	3 1/2"	1	10	75.75 EA
	852-3LTR	tenz	3" MIP	5 1/2"	—	2 1/2"	1	10	32.25 EA
	852-4LTR	tenz	4" MIP	6 1/2"	—	3 1/2"	1	10	41.75 EA
INDIVIDUALLY BAR-CODED IN A CUT CASE BOX									
	852-4LNRPK	nickel	4" MIP	6 1/2"	—	3 1/2"	5	5	56.52 EA

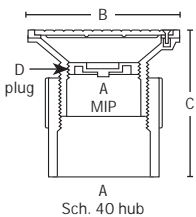

Adjustable Cleanout PVC MIP Thread

Square Cast Metal Ring and Cover

- Square ring is great for square floor tile
- Polypro plug included
- Brass female thread inserts accept cover screws
- MIP thread top housing adapts to any FIP adapter
- For use in pedestrian traffic areas



852-3PNQ



852-3LNQ

SUPPLY

DRAINAGE

SUPPORT

TESTING

SPECIALTIES

TOOLS

ACCESS

Related Products

Replacement covers	p 184
Available adapters	p 178-180

Options: Add letter suffix. Add prices to list.

V – Vandal-resistant screws \$5.00

S – Stamped cover: specify ST or SAN \$5.00

9 – Fitting socket ring* –\$0.75

*9 only applies to series with adapter.

PVC Item No.	ABS Item No.	Ring & Strainer	Dimensions				Min. Qty.	Case Qty.	List Price
			A	B	C	D			
WITH ADAPTER									
INDIVIDUALLY BAR-CODED BULK									
852-3PNQ	852-3ANQ	nickel	3" hub	5 ¹¹ / ₁₆ "	4 ¹ / ₄ – 5 ¹ / ₂ "	2 ¹ / ₂ "	1	2	81.75 EA
852-4PNQ	852-4ANQ	nickel	4" hub	6 ¹¹ / ₁₆ "	4 ¹ / ₂ – 5 ³ / ₄ "	3 ¹ / ₂ "	1	2	91.25 EA
852-3PBQ	852-3ABQ	brass	3" hub	5 ¹¹ / ₁₆ "	4 ¹ / ₄ – 5 ¹ / ₂ "	2 ¹ / ₂ "	1	5	86.25 EA
852-4PBQ	852-4ABQ	brass	4" hub	6 ¹¹ / ₁₆ "	4 ¹ / ₂ – 5 ³ / ₄ "	3 ¹ / ₂ "	1	5	101.25 EA
NO ADAPTER									
INDIVIDUALLY BAR-CODED BULK									
852-3LNQ		nickel	3" MIP	5 ¹¹ / ₁₆ "	4 ¹ / ₄ – 5 ¹ / ₂ "	2 ¹ / ₂ "	1	1	75.75 EA
852-4LNQ		nickel	4" MIP	6 ¹¹ / ₁₆ "	4 ¹ / ₂ – 5 ³ / ₄ "	3 ¹ / ₂ "	1	1	84.00 EA
852-3LBQ		brass	3" MIP	5 ¹¹ / ₁₆ "	4 ¹ / ₄ – 5 ¹ / ₂ "	2 ¹ / ₂ "	1	1	80.25 EA
852-4LBQ		brass	4" MIP	6 ¹¹ / ₁₆ "	4 ¹ / ₂ – 5 ³ / ₄ "	3 ¹ / ₂ "	1	1	78.25 EA

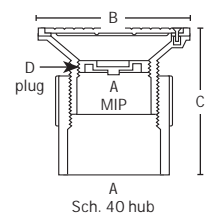



852-3Pi



852-3PP



852-3Li



852-3LP

Adjustable Cleanout PVC MIP Thread

Cast Iron Ring and Cover

- Polypro plug with threaded brass insert for cover screw included
- Brass female thread inserts accept ring screws
- MIP thread top housing adapts to any FIP adapter
- For use in heavy duty applications

PVC Cover

- Polypro plug included
- Brass female thread inserts accept cover screws
- MIP thread top housing adapts to any FIP adapter
- For use in pedestrian traffic areas

Related Products	
Replacement covers	p 184
Available adapters	p 178-180

Options: Add letter suffix. Add prices to list.

V—Vandal-resistant screws \$5.00

S—Stamped cover: specify ST or SAN \$5.00

9—Fitting socket ring* —\$0.75

***S** not available on cast iron covers.

***9** only available on items with adapter.

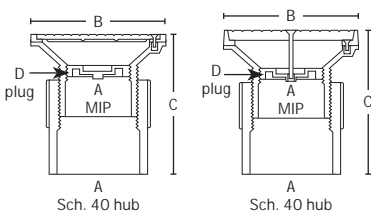

PVC Item No.	ABS Item No.	Ring & Cover	Dimensions				Min. Qty.	Case Qty.	List Price
			A	B	C	D			
WITH ADAPTER									
INDIVIDUALLY BAR-CODED BULK									
852-3Pi	852-3Ai	iron	3" hub	6 ¹ / ₁₆ "	4 ³ / ₄ "—6"	2 ¹ / ₂ "	1	2	40.75 EA
852-4Pi	852-4Ai	iron	4" hub	6 ¹¹ / ₁₆ "	5 ¹ / ₈ "—6 ³ / ₈ "	3 ¹ / ₂ "	1	2	53.00 EA
852-3PP	852-3AP	PVC	3" hub	5 ¹ / ₂ "	4 ¹ / ₄ "—5 ¹ / ₂ "	2 ¹ / ₂ "	1	1	20.25 EA
852-4PP	852-4AP	PVC	4" hub	6 ¹ / ₂ "	4 ⁵ / ₈ "—5 ³ / ₈ "	3 ¹ / ₂ "	1	1	27.50 EA
NO ADAPTER									
INDIVIDUALLY BAR-CODED BULK									
852-3Li		iron	3" MIP	6 ¹ / ₁₆ "	4 ³ / ₄ "—6"	2 ¹ / ₂ "	1	2	34.75 EA
852-4Li		iron	4" MIP	6 ¹¹ / ₁₆ "	5 ¹ / ₈ "—6 ³ / ₈ "	3 ¹ / ₂ "	1	2	45.75 EA
852-3LP		PVC	3" hub	5 ¹ / ₂ "	4 ¹ / ₄ "—5 ¹ / ₂ "	2 ¹ / ₂ "	1	10	14.25 EA
852-4LP		PVC	4" hub	6 ¹ / ₂ "	4 ⁵ / ₈ "—5 ³ / ₈ "	3 ¹ / ₂ "	1	10	20.25 EA

Adjustable Cleanout Cast Iron MIP Thread

Round Cast Nickel Ring and Cover

- MIP thread top housing adapts to any FIP adapter
- Polypro plug included
- For use in pedestrian traffic areas

Square Cast Nickel Ring and Cover

- Square ring is great for square floor tile
- MIP thread top housing adapts to any FIP adapter
- Polypro plug included
- For use in pedestrian traffic areas

Cast Iron Ring and Cover

- MIP thread top housing adapts to any FIP adapter
- Polypro plug included
- For use in heavy duty applications

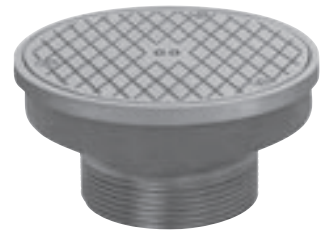

852-4iLNR

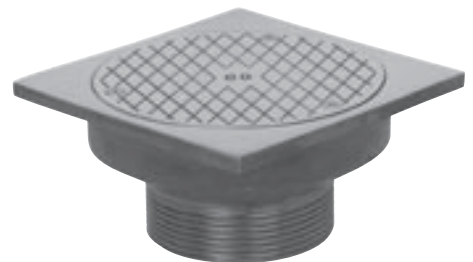

852-4iLNO



852-4iLi

SUPPLY

DRAINAGE

SUPPORT

TESTING

SPECIALTIES

TOOLS

ACCESS

Related Products

Replacement covers p 184
Available adapters p 178-180

Options: Add letter suffix. Add prices to list.

V – Vandal-resistant screws \$5.00

S – Stamped cover: specify ST or SAN \$5.00

***S** not available on cast iron covers.

Item No.	Dimensions				Min. Qty.	Case Qty.	List Price
	A	B	C	D			
ROUND NICKEL RING AND COVER							
INDIVIDUALLY BAR-CODED BULK							
852-4iLNR	4"	6½"	2¾"	3½"	1	2	91.25 EA
SQUARE NICKEL RING AND COVER							
INDIVIDUALLY BAR-CODED BULK							
852-4iLNO	4"	6 11/16"	2¾"	3½"	1	1	112.00 EA
CAST IRON RING AND COVER							
INDIVIDUALLY BAR-CODED BULK							
852-4iLi	4"	6 11/16"	3 5/8"	3½"	1	1	73.75 EA

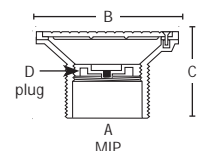



851-44N



851-44i

Adjustable Cleanout Solvent Weld Connection

Cast Nickel Cover

Cast Tenzalloy Cover

Cast Iron Cover

Laminated Cast Iron Cover

- Polypro plug with threaded brass insert for cover screw included
- Over 1 1/2" of vertical adjustment available
- Nickel and tenz covers for use in pedestrian traffic areas
- Cast iron covers for use in heavy duty applications



For any light commercial application.

Related Products
Replacement covers

p 185

Options: Add letter suffix. Add prices to list.
V – Vandal-resistant cover screw \$5.00
S – Stamped cover: specify ST or SAN* \$5.00
 *S not available on cast iron covers.

PVC Item No.	ABS Item No.	Dimensions				Min. Qty.	Case Qty.	List Price
		A	B	C	D			
NICKEL COVER								
INDIVIDUALLY BAR-CODED BULK								
851-43N	851-33N	3"	4 3/8"	3 1/2" – 4 1/2"	3"	1	2	82.00 EA
851-44N	851-34N	4"	6"	3 3/4" – 4 3/4"	4"	1	2	92.00 EA
851-46N	851-36N	6"	8 3/8"	5 1/2" – 6 3/4"	6"	1	2	168.00 EA
TENZALLOY COVER								
INDIVIDUALLY BAR-CODED BULK								
851-43T	851-33T	3"	4 3/8"	3 1/2" – 4 1/2"	3"	1	2	58.50 EA
851-44T	851-34T	4"	6"	3 3/4" – 4 3/4"	4"	1	2	68.00 EA
851-46T	851-36T	6"	8 3/8"	5 1/2" – 6 3/4"	6"	1	2	110.00 EA
CAST IRON COVER								
INDIVIDUALLY BAR-CODED BULK								
851-44i	851-34i	4"	6"	4 1/2" – 6 1/4"	4"	1	2	55.00 EA
851-46i	851-36i	6"	8 1/2"	6" – 7 3/4"	6"	1	2	109.00 EA
NICKEL LAMINATED CAST IRON COVER								
INDIVIDUALLY BAR-CODED BULK								
851-44iN	851-34iN	4"	6"	4 3/4" – 6 1/2"	4"	1	2	136.00 EA
851-46iN	851-36iN	6"	8 1/2"	6 1/4" – 8"	6"	1	2	222.75 EA

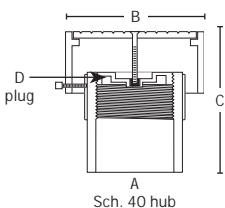

SUPPLY

DRAINAGE

SUPPORT

TESTING

SPECIALTIES

TOOLS

ACCESS

Adjustable Cleanout Cast Iron No-Hub Connection

Cast Nickel Cover

Cast Tenzalloy Cover

Cast Iron Cover

Laminated Cast Iron Cover

- Polypro plug with threaded brass insert for cover screw included
- Over 1 ½" of vertical adjustment available
- Nickel and tenz covers for use in pedestrian traffic areas
- Cast iron covers for use in heavy duty applications



851-24N



851-24i

SUPPLY

DRAINAGE

SUPPORT

TESTING

SPECIALTIES

TOOLS

ACCESS

Related Products

Replacement covers p 185

Options: Add letter suffix. Add prices to list.

V – Vandal-resistant cover screw \$5.00

S – Stamped cover: specify ST or SAN* \$5.00

*S not available on cast iron covers.

Item No.	Dimensions				Min. Qty.	Case Qty.	List Price
	A	B	C	D			
NICKEL COVER							
INDIVIDUALLY BAR-CODED BULK							
851-24N	4"	6"	3 ¼" – 4 ½"	4"	1	2	107.00 EA
851-26N	6"	8 ⅜"	3 ⅜" – 5"	5"	1	2	192.75 EA
TENZALLOY COVER							
INDIVIDUALLY BAR-CODED BULK							
851-24T	4"	6"	3 ¼" – 4 ½"	4"	1	2	83.00 EA
851-26T	6"	8 ⅜"	3 ⅜" – 5"	5"	1	2	148.50 EA
CAST IRON COVER							
INDIVIDUALLY BAR-CODED BULK							
851-24i	4"	6"	3 ¼" – 5 ¾"	4"	1	2	65.00 EA
851-26i	6"	7 ⅞"	4 ½" – 6"	5"	1	2	115.00 EA
NICKEL LAMINATED CAST IRON COVER							
INDIVIDUALLY BAR-CODED BULK							
851-24iN	4"	7 ⅞"	4" – 6"	4"	1	2	146.00 EA
851-26iN	6"	7 ⅞"	4 ¾" – 6 ¼"	5"	1	2	228.75 EA

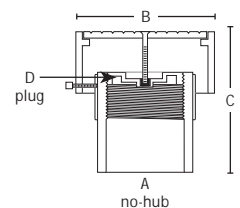



851-64N



851-64i

Adjustable Cleanout Cast Iron Push-Joint Connection

Cast Nickel Cover

Cast Tenzalloy Cover

Cast Iron Cover

- Neoprene gasket, polypro plug with threaded brass insert included
- Over 1 1/2" of vertical adjustment available
- Nickel and tenz covers for use in pedestrian traffic areas
- Cast iron covers for use in heavy duty applications

Related Products

Replacement covers

p 185

Options: Add letter suffix. Add prices to list.
V—Vandal-resistant cover screw \$5.00
S—Stamped cover: specify ST or SAN* \$5.00
 *S not available on cast iron covers.

Item No.	Dimensions				Min. Qty.	Case Qty.	List Price
	A	B	C	D			
NICKEL COVER							
INDIVIDUALLY BAR-CODED BULK							
851-64N	4"	6"	4"–5 1/4"	4"	1	2	122.00 EA
851-66N	6"	8 3/8"	4 3/4"–6"	6"	1	2	277.75 EA
TENZALLOY COVER							
INDIVIDUALLY BAR-CODED BULK							
851-64T	4"	6"	4"–5 1/4"	4"	1	2	98.00 EA
851-66T	6"	8 3/8"	4 3/4"–6"	6"	1	2	230.50 EA
CAST IRON COVER							
INDIVIDUALLY BAR-CODED BULK							
851-64i	4"	6"	5 1/4"–6 1/2"	4"	1	2	80.00 EA
851-66i	6"	8 3/8"	4 3/4"–6"	6"	1	2	197.00 EA

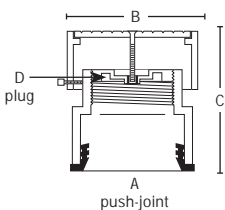

SUPPLY

DRAINAGE

SUPPORT

TESTING

SPECIALTIES

TOOLS

ACCESS

Adjustable Access Cover Set Screw Connection

Cast Nickel Cover

Cast Tenzalloy Cover

Cast Iron Cover

Laminated Cast Iron Cover

- Set screw allows up to 1 1/2" of vertical adjustment over pipe or fitting
- 850-234N model fits over 2", 3", or 4" pipe and 2" or 3" FIP adapters
- Nickel and tenz covers for use in pedestrian traffic areas
- Cast iron covers for use in heavy duty applications



850-234N



850-4N



850-4i

Related Products
Replacement covers p 185

Options: Add letter suffix. Add prices to list.
V – Vandal-resistant cover screw \$5.00
S – Stamped cover: specify ST or SAN* \$5.00
 *S not available on cast iron covers.

Item No.	Dimensions				Min. Qty.	Case Qty.	List Price
	A	B	C	D			
NICKEL COVER							
INDIVIDUALLY BAR-CODED BULK							
850-234N	5 1/2"	5 1/2"	2 13/16"	4"	1	10	60.50 EA
850-2N	5 3/8"	6 1/2"	2 3/8"	5 5/16"	1	6	114.75 EA
850-3N	6 5/8"	7 1/8"	2 3/4"	5 9/16"	1	6	156.75 EA
850-4N	8 5/8"	9 1/8"	2 3/4"	7 1/4"	1	6	205.00 EA
TENZALLOY COVER							
INDIVIDUALLY BAR-CODED BULK							
850-2T	5 3/8"	6 1/2"	2 3/8"	5 5/16"	1	6	51.25 EA
850-3T	6 5/8"	7 1/8"	2 3/4"	5 9/16"	1	6	64.75 EA
850-4T	8 5/8"	9 1/8"	2 3/4"	7 1/4"	1	1	98.50 EA
CAST IRON COVER							
INDIVIDUALLY BAR-CODED BULK							
850-2i	5 1/2"	6"	3"	4 1/2"	1	6	45.00 EA
850-3i	6 5/8"	7 1/8"	3"	5 5/8"	1	4	50.00 EA
850-4i	8"	8 1/2"	3"	7 1/8"	1	2	65.00 EA
NICKEL LAMINATED CAST IRON COVER							
INDIVIDUALLY BAR-CODED BULK							
850-2iN	5 1/2"	6"	3 1/4"	4 1/2"	1	6	159.50 EA
850-3iN	6 5/8"	7 1/8"	3 1/4"	5 5/8"	1	4	176.00 EA
850-4iN	8"	8 1/2"	3 1/4"	7 1/8"	1	2	221.00 EA

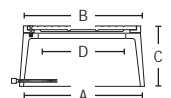

Cleanout Cover

- Flat and raised ABS models in chrome plated, white and ivory finishes
- Stainless steel models in standard 20 gauge or thicker, stronger 16 gauge



870-96



871-16

Options: Add letter suffix. Add prices to list.
S—Stamped cover: specify ST, SAN or CO* \$5.00
***S** only available on stainless steel covers.

Item No.	Diameter	Height	Material	Min. Qty.	Case Qty.	List Price
FLAT CLEANOUT COVER						
INDIVIDUALLY BAR-CODED BULK						
871-4	4½"	—	white ABS	25	25	2.40 EA
871-6	6½"	—	white ABS	25	25	4.50 EA
871-8	8½"	—	white ABS	1	10	7.20 EA
872-4	4½"	—	chrome plated ABS	25	25	7.50 EA
872-6	7¼"	—	chrome plated ABS	25	25	10.75 EA
872-8	8½"	—	chrome plated ABS	1	10	13.25 EA
870-93	3"	—	16 gauge stainless steel	1	10	3.75 EA
870-94	4"	—	16 gauge stainless steel	1	10	6.00 EA
870-95	5"	—	16 gauge stainless steel	1	10	8.00 EA
870-96	6"	—	16 gauge stainless steel	1	10	9.75 EA
870-98	8"	—	16 gauge stainless steel	1	10	12.75 EA
870-3	3"	—	20 gauge stainless steel	25	25	3.50 EA
870-4	4"	—	20 gauge stainless steel	25	25	4.00 EA
870-5	5"	—	20 gauge stainless steel	25	25	6.50 EA
870-6	6"	—	20 gauge stainless steel	25	25	6.75 EA
870-8	8"	—	20 gauge stainless steel	10	10	8.50 EA
870-810	10"	—	20 gauge stainless steel	5	5	15.25 EA
870-812	12½"	—	20 gauge stainless steel	5	5	21.25 EA
RAISED CLEANOUT COVER						
INDIVIDUALLY BAR-CODED BULK						
871-16	7¼"	1¼"	white ABS	25	25	11.25 EA
871-18	9¼"	1¼"	ivory ABS	1	10	15.00 EA
872-16	7¼"	1¼"	chrome plated ABS	25	25	14.50 EA
872-18	9¼"	1¼"	chrome plated ABS	1	10	20.75 EA



SUPPLY

DRAINAGE

SUPPORT

TESTING

SPECIALTIES

TOOLS

ACCESS

Cleanout Cover Kit

20 Gauge Stainless Steel

- Available with 9" wall bar or countersunk brass plug

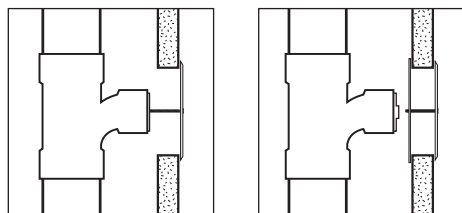

Options: Add letter suffix. Add prices to list.
S – Stamped cover: specify ST, SAN or CO* \$5.00
***S** is only available on kits with 9" bar.

Item No.	Cover Diameter	Screw Length	Plug Size	Min. Qty.	Case Qty.	List Price
COVER, SCREW AND COUNTERSUNK BRASS PLUG						
INDIVIDUALLY BAR-CODED BULK						
873-240	4"	2 1/4"	2" IPS	1	10	11.70 EA
873-350	5"	2 1/4"	3" IPS	1	10	17.35 EA
873-460	6"	2 1/4"	4" IPS	1	10	22.50 EA
COVER, SCREW AND SLOTTED POLYPRO PLUG						
INDIVIDUALLY BAR-CODED BULK						
873-240P	4"	2 1/4"	2" IPS	1	1	9.75 EA
873-350P	5"	2 1/4"	3" IPS	1	1	13.25 EA
873-460P	6"	2 1/4"	4" IPS	1	1	16.00 EA
COVER, SCREW AND 9" BAR						
INDIVIDUALLY BAR-CODED BULK						
870-B3	3"	6"	–	1	10	8.00 EA
870-B4	4"	6"	–	1	10	8.50 EA
870-B5	5"	6"	–	1	10	12.00 EA
870-B6	6"	6"	–	1	10	13.50 EA
870-B8	8"	6"	–	1	10	16.50 EA
INDIVIDUALLY BAR-CODED BULK						
870-B6PK1	6"	6"	–	10	10	14.68 EA
COVER AND SCREW						
BAR-CODED CLAMSHELLS IN A CUT CASE BOX						
870-3PK1	3"	4"	–	10	10	4.68 EA
870-4PK1	4"	4"	–	10	10	5.18 EA
870-6PK1	6"	4"	–	10	10	7.93 EA



870-B3



873-240

SUPPLY

DRAINAGE

SUPPORT

TESTING

SPECIALTIES

TOOLS

ACCESS



Cleanout Cover Accessories

1/4" x 20 Threaded Wall Bars

Item No.	Length	Min. Qty.	Case Qty.	List Price
870-B	9"	25	25	2.75 EA

Carpet Marker for Cleanouts

Item No.	Description	Min. Qty.	Case Qty.	List Price
870-2	Stainless steel carpet marker	1	25	2.00 EA
870-2CM	Stainless steel carpet marker with 1 1/2" screw	1	25	2.75 EA

1/4" x 20 Cleanout Cover Screw

Item No.	Length	Min. Qty.	Case Qty.	List Price
STAINLESS STEEL SCREWS				
874-1	1 1/2"	25	1000	0.75 EA
874-2	2 1/4"	25	1000	1.15 EA
874-4	4"	25	500	2.00 EA
874-6	6"	25	1000	3.50 EA
CHROME PLATED SCREWS				
874-1C	1 1/2"	25	1000	1.40 EA
874-3C	3"	25	500	1.25 EA
874-4C	4 1/2"	25	500	1.50 EA
874-6C	6"	25	100	2.25 EA
WHITE EPOXY COATED SCREWS				
874-1W	1 1/2"	25	100	2.20 EA
874-3W	3"	25	1000	2.75 EA
874-4W	4 1/2"	25	100	2.85 EA
874-6W	6"	25	100	4.95 EA

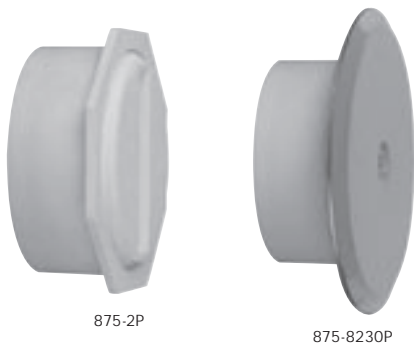
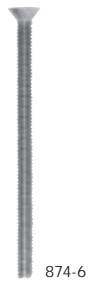

Cleanout Bushing

- Bushing fits inside Sch. 40 pipe
- Plugs have threaded brass inserts
- Cleanout bushing kits includes:
 - Bushing
 - 16 gauge stainless steel cleanout cover
 - 3/4" stainless steel screw

Options: Add letter suffix. Add prices to list.

V—Vandal-resistant cover screw

\$5.00

PVC Item No.	ABS Item No.	Dimensions				Min. Qty.	Case Qty.	List Price
		A	B	C	D			
CLEANOUT BUSHING								
INDIVIDUALLY BAR-CODED BULK								
875-2P	875-2A	2"	1 1/2"	1 1/4"	—	20	20	4.50 EA
875-3P	875-3A	3"	2 1/2"	1 1/4"	—	20	20	5.75 EA
875-4P	875-4A	4"	3 1/2"	1 1/4"	—	20	20	7.00 EA
CLEANOUT BUSHING KIT								
INDIVIDUALLY BAR-CODED BULK								
875-8230P	—	2"	1 1/2"	1 1/4"	3"	1	10	10.50 EA
875-8340P	—	3"	2 1/2"	1 1/4"	4"	1	10	13.50 EA
875-8450P	—	4"	3 1/2"	1 1/4"	5"	1	5	14.85 EA

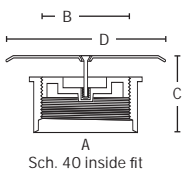

Residential Drainage

Shower Drains
Floor Drains
Closet Flanges
Backwater Valves

SUPPLY

DRAINAGE

SUPPORT

TESTING

SPECIALTIES

TOOLS

ACCESS





821-200P



821-2780P

Solvent Weld Shower Pan Drain

Screw-on 18 Gauge Strainer—Plastic Rim

- PVC head adapter provides rim around strainer for easy strainer replacement in tile applications
- Threaded brass inserts in drain body for collar screws

Screw-on 18 Gauge Strainer—Full Metal Top

- Strainer completely covers head adapter, leaving no plastic rim showing
- Threaded brass inserts in drain body for collar screws

Snap-in 18 Gauge Strainer—Plastic Rim

- PVC head adapter provides rim around strainer for easy strainer replacement in tile applications
- Threaded brass inserts in drain body for collar screws
- Strainer fingers grip slots in drain body to prevent slipping and turning

Snap-in 18 Gauge Strainer—Full Metal Top

- Strainer completely covers head adapter, leaving no plastic rim showing
- Threaded brass inserts in drain body for collar screws
- Strainer fingers grip slots in drain body to prevent slipping and turning

Related Products	
Replacement strainers	p 182
Grip Tip	p 229

PVC Item No.	ABS Item No.	Dimensions			Brass Inserts in Head	Min. Qty.	Case Qty.	List Price
		A	B	C				
SCREW-ON STAINLESS STEEL STRAINER—PLASTIC RIM								
INDIVIDUALLY BAR-CODED BULK								
821-200P	821-200A	2"	4 ³ / ₈ "	3 ⁵ / ₈ "–5 ⁵ / ₈ "	✓	20	20	9.95 EA
821-2P	821-2A	2"	4 ³ / ₈ "	3 ⁵ / ₈ "–5 ⁵ / ₈ "		20	20	9.25 EA
INDIVIDUALLY BAR-CODED IN A CUT CASE BOX								
821-200PPK	821-200APK	2"	4 ³ / ₈ "	3 ⁵ / ₈ "–5 ⁵ / ₈ "	✓	8	8	11.22 EA
SCREW-ON PVD POLISHED BRASS STRAINER—PLASTIC RIM								
INDIVIDUALLY BAR-CODED BULK								
821-200PP	821-200AP	2"	4 ³ / ₈ "	3 ⁵ / ₈ "–5 ⁵ / ₈ "	✓	20	20	17.00 EA
SCREW-ON STAINLESS STEEL STRAINER—FULL METAL TOP								
INDIVIDUALLY BAR-CODED BULK								
821-2080P	821-2080A	2"	4 ¹ / ₄ "	3 ⁵ / ₈ "–5 ⁵ / ₈ "	✓	20	20	10.45 EA
821-280P	821-280A	2"	4 ¹ / ₄ "	3 ⁵ / ₈ "–5 ⁵ / ₈ "		20	20	9.95 EA
SNAP-IN STAINLESS STEEL STRAINER—PLASTIC RIM								
INDIVIDUALLY BAR-CODED BULK								
821-270P	821-270A	2"	4 ³ / ₈ "	3 ⁵ / ₈ "–5 ⁵ / ₈ "		20	20	9.20 EA
SNAP-IN STAINLESS STEEL STRAINER—FULL METAL TOP								
INDIVIDUALLY BAR-CODED BULK								
821-2780P	821-2780A	2"	4 ¹ / ₄ "	3 ⁵ / ₈ "–5 ⁵ / ₈ "		1	10	9.70 EA

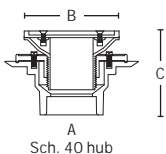

Solvent Weld Shower Pan Drain

Cast Metal Ring and Strainer

- Machine screws and threaded brass inserts in drain body and head adapter
- Beveled flashing body for easy subfloor installation
- Square ring is perfect for tile floors

Cast Metal Head Adapter and Strainer

- Chrome plated or polished brass finish available
- Head adapter available separately
- Beveled flashing body for easy subfloor installation
- Threaded brass inserts for collar screws



821-200PNR



821-200PNQ



821-2PCP

Related Products

Replacement strainers p 182
Grip Tip p 229

PVC Item No.	ABS Item No.	Ring and Strainer	Dimensions			Min. Qty.	Case Qty.	List Price
			A	B	C			
CAST NICKEL RING AND STRAINER								
INDIVIDUALLY BAR-CODED BULK								
821-200PNR	821-200ANR	round	2"	4 1/2"	3 15/16" - 5 15/16"	5	5	35.00 EA
821-200PNQ	821-200ANQ	square	2"	4 9/16"	3 15/16" - 5 15/16"	1	5	45.00 EA
CAST BRASS RING AND STRAINER								
INDIVIDUALLY BAR-CODED BULK								
821-200PBR	821-200ABR	round	2"	4 1/2"	3 15/16" - 5 15/16"	1	5	44.25 EA
821-200PBQ	821-200ABQ	square	2"	4 9/16"	3 15/16" - 5 15/16"	1	5	58.50 EA
CAST OIL-RUBBED BRONZE RING AND STRAINER								
INDIVIDUALLY BAR-CODED BULK								
821-200PRBR	821-200ARBR	round	2"	4 1/2"	3 15/16" - 5 15/16"	1	5	71.50 EA
821-200PRBQ	821-200ARBQ	square	2"	4 9/16"	3 15/16" - 5 15/16"	1	5	108.50 EA
CHROME PLATED HEAD ADAPTER AND STRAINER								
INDIVIDUALLY BAR-CODED BULK								
821-2PCP	821-2ACP	round	2"	4 1/4"	3 1/2" - 4 3/4"	1	5	30.75 EA
	821-HCP	round	2" MIP head adapter only			1	5	28.25 EA
POLISHED BRASS HEAD ADAPTER AND STRAINER								
INDIVIDUALLY BAR-CODED BULK								
821-2PBP	821-2ABP	round	2"	4 1/4"	3 1/2" - 4 3/4"	1	5	36.00 EA
	821-HBP	round	2" MIP head adapter only			1	5	28.75 EA

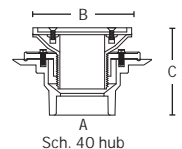



825-20P



825-27P

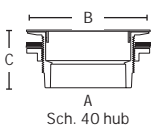
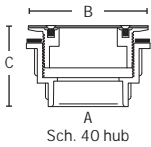

Solvent Weld Shower Module Drain

Screw-on 18 Gauge Strainer

- Models with threaded brass inserts in drain body use machine screws which make strainer replacement fast and easy
- Models without brass inserts use standard screws that thread into pilot holes in drain body
- New 1 1/2" hub connection is also 2" spigot connection

Snap-in 18 Gauge Strainer

- Strainer fingers grip slots in drain body to prevent slipping and turning
- New 1 1/2" hub connection is also 2" spigot connection

Related Products
 Replacement strainers p 182
 Grip Tip p 229

PVC Item No.	ABS Item No.	Dimensions			Brass Inserts	Min. Qty.	Case Qty.	List Price
		A	B	C				
SCREW-ON STAINLESS STEEL STRAINER								
INDIVIDUALLY BAR-CODED BULK								
825-10P	825-10A	1 1/2"	4 1/4"	2 5/8"	✓	20	20	7.75 EA
825-20P	825-20A	2"	4 1/4"	2 5/8"	✓	20	20	7.75 EA
825-1P	825-1A	1 1/2"	4 1/4"	2 5/8"		20	20	6.50 EA
825-2P	825-2A	2"	4 1/4"	2 5/8"		20	20	6.50 EA
INDIVIDUALLY BAR-CODED IN A CUT CASE BOX								
825-2PPK	825-2APK	2"	4 1/4"	2 5/8"		12	12	6.63 EA
SCREW-ON PVD POLISHED BRASS STRAINER								
INDIVIDUALLY BAR-CODED BULK								
825-2PP	—	2"	4 1/4"	2 5/8"		1	5	13.50 EA
SNAP-IN STAINLESS STEEL STRAINER								
INDIVIDUALLY BAR-CODED BULK								
825-17P	825-17A	1 1/2"	4 1/4"	2 5/8"		20	20	6.35 EA
825-27P	825-27A	2"	4 1/4"	2 5/8"		20	20	6.35 EA
SNAP-IN PVD POLISHED BRASS STRAINER								
INDIVIDUALLY BAR-CODED BULK								
825-27PP	—	2"	4 1/4"	2 5/8"		1	5	13.25 EA

Screw-on 18 Gauge Strainer with Outer Locknut

- ABS or PVC drain body with outer locknut
- Strainer fingers grip slots in drain body to prevent slipping and turning

Related Products
 Replacement strainers p 182
 Grip Tip p 229

PVC Item No.	ABS Item No.	Dimensions			Min. Qty.	Case Qty.	List Price
		A	B	C			
SCREW-ON STAINLESS STEEL STRAINER							
INDIVIDUALLY BAR-CODED BULK							
829-2P	829-2A	2"	4 1/4"	2 5/8"	20	20	10.00 EA

No-Caulk Shower Module Drain

JackRabbit™

Jacking Bolt Shower Drain

- Perfect for replacement applications when workspace is restricted by building members and existing pipe
- Unique design uses stainless steel “jacking bolts” and a pressure plate washer to create a seal—no need to wrench tighten the outer locknut
- Brass body, locknut and pressure plate washer with elastomer no-caulk gasket
- Internal gasket wrench is included

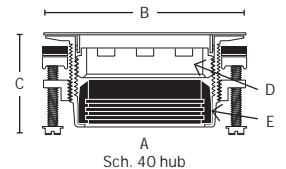
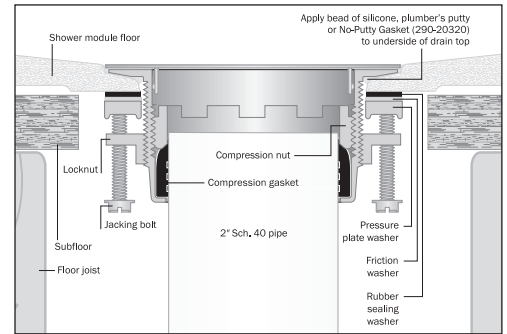

Related Products
 Replacement strainers p 182
 Grip Tip p 229

Item No.	Dimensions			Min. Qty.	Case Qty.	List Price
	A	B	C			
STAINLESS STEEL STRAINER						
BAR-CODED CLAMSHELLS IN A CUT CASE BOX						
827-2J	2"	4 1/4"	2 1/8"	1	6	32.00 EA
REPLACEMENT PARTS						
827-2BN	Compression gasket nut (D)—brass			1	10	4.00 EA
827-2BG	Compression gasket (E)—elastomer			1	10	1.75 EA

Brass Body with Snap-in 18 Gauge Strainer

- Brass body and locknut with elastomer no-caulk gasket
- Internal gasket wrench is included

PVC Body with Snap-in 18 Gauge Strainer

- PVC body and locknut with elastomer no-caulk gasket
- Internal gasket wrench is included



827-2B



828-2

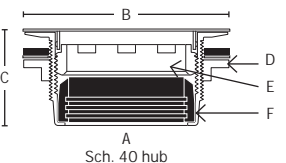

Related Products
 Replacement strainers p 182
 Grip Tip p 229

Item No.	Dimensions			Min. Qty.	Case Qty.	List Price
	A	B	C			
CAST BRASS BODY WITH STAINLESS STEEL STRAINER						
BAR-CODED CLAMSHELLS IN A CUT CASE BOX						
827-2B	2"	4 1/4"	2 1/8"	1	10	20.45 EA
CAST BRASS BODY WITH PVD POLISHED BRASS STRAINER						
BAR-CODED CLAMSHELLS IN A CUT CASE BOX						
827-2BP	2"	4 1/4"	2 1/8"	1	10	26.47 EA
PVC BODY WITH STAINLESS STEEL STRAINER						
BULK						
828-2	2"	4 1/4"	2 1/8"	1	20	8.00 EA
INDIVIDUALLY BAR-CODED IN A CUT CASE BOX						
828-2PK	2"	4 1/4"	2 1/8"	10	10	8.13 EA
PVC BODY WITH PVD POLISHED BRASS STRAINER						
828-2P	2"	4 1/4"	2 1/8"	1	20	13.75 EA
REPLACEMENT PARTS						
827-2BLN	Brass outer locknut (D)			1	10	5.68 EA
827-2BN	Brass compression gasket nut (E)			1	10	4.00 EA
827-2BG	Elastomer compression gasket (F)			1	10	1.75 EA



Push-Joint Shower Module Drain

Snap-in 18 Gauge Strainer

- PVC drain body with outer locknut
- Elastomer push-joint gasket installs over 2" Sch. 40 pipe

Related Products		
Replacement strainers	p 182	
Grip Tip	p 229	

Item No.	Dimensions			Min. Qty.	Case Qty.	List Price
	A	B	C			
STAINLESS STEEL STRAINER						
INDIVIDUALLY BAR-CODED BULK						
829-S2	2"	4 1/4"	2 5/16"	1	20	16.00 EA

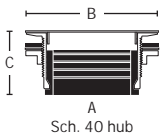

SUPPLY

DRAINAGE

SUPPORT

Push-Joint/Solvent Weld Shower Module Drain

- Use elastomer push-joint gasket or solvent weld connection

Related Products		
Replacement strainers	p 182	
Grip Tip	p 229	

PVC Item No.	ABS Item No.	Dimensions			Min. Qty.	Case Qty.	List Price
		A	B	C			
STAINLESS STEEL STRAINER							
INDIVIDUALLY BAR-CODED BULK							
826-2P	826-2A	2"	4 1/4"	2 5/8"	1	20	15.50 EA
INDIVIDUALLY BAR-CODED IN A CUT CASE BOX							
826-2PPK	—	2"	4 1/4"	2 5/8"	10	10	15.63 EA

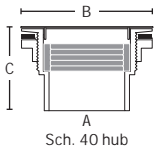

TESTING

SPECIALTIES

Solvent Weld Offset Shower Module Drain

- Provides a 3/4" offset in any direction
- Use when drain pipe was not roughed-in correctly

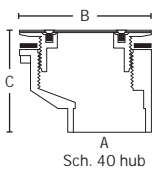

PVC Item No.	ABS Item No.	Dimensions			Min. Qty.	Case Qty.	List Price
		A	B	C			
STAINLESS STEEL STRAINER							
INDIVIDUALLY BAR-CODED IN A CUT CASE BOX							
825-2PFS	825-2AFS	2"	4 1/4"	2"	10	10	10.75 EA

TOOLS

ACCESS

Weld One™ Integral Trap Floor Drain

Patent # 280,925

- ABS or PVC solvent weld connection
- Over 20 years of proven performance
- The most widely used and trusted integral-trap floor drain in the country
- Pitched hub outlet allows for level drain installation without extra fittings
- 3¾" deep sump bowl and a full 3" trap seal
- One piece ABS or PVC drain body is sonic welded—NOT GLUED



Outlet hub is pitched downward 2° for proper drainage fall.



Adhesive debris cover protects drain during pour and removes with no residue.

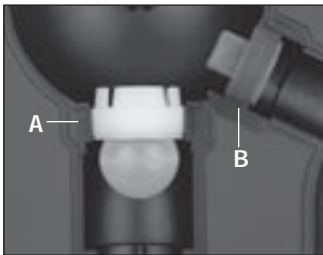

A 2" FIP drain throat is designed to fit the 802-7 backwater device or laundry standpipe. Backwater device is available installed (800-PBW, 800-ABW) or can be purchased separately. (See below.)

B 1½" cleanout plug is pre-installed into FIP cleanout threads.

Related Products
Replacement strainers p 181

Options: Add letter suffix. Add price to list.
T—Tapped ¾" FIP trap primer port \$8.00

PVC Item No.	ABS Item No.	Dimensions				Min. Qty.	Case Qty.	List Price
		A	B	C	D			
WHITE OR BLACK POLYPRO STRAINER								
INDIVIDUALLY BAR-CODED BULK								
800-P	800-A	2"	7¼"	11⅝"	13½"	12	12	21.00 EA
800-PBW	800-ABW	Weld One with 802-7 backwater device installed				12	12	28.00 EA
INDIVIDUALLY BAR-CODED IN A CUT CASE BOX								
800-PPK	800-APK	2"	7¼"	11⅝"	13½"	3	3	22.20 EA
CAST NICKEL RING & STRAINER								
INDIVIDUALLY BAR-CODED BULK								
800-PNR	800-ANR	2"	7¼"	11⅝"	13½"	1	2	74.00 EA

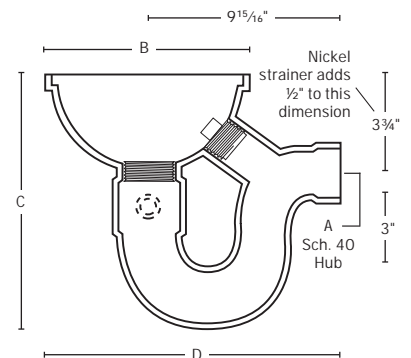

Backwater Device

2" MIP Body

- Polypropylene thread body and float ball with EPDM sealing gasket
- For use in 2" FIP threaded drain throat
- Not designed for air or water test



Item No.	Description	Min. Qty.	Case Qty.	List Price
BAR-CODED BAGS IN A CUT CASE BOX				
802-7	Polypro backwater device for 2" FIP threads	12	12	5.12 EA





2" x 3" Quad Drain™ General Purpose Floor Drain

- ABS or PVC solvent weld connection
- Custom fit your own P-trap or areaway
- Outlet welds over 2" or inside 3" Sch. 40 pipe
- Option H allows for stand pipe installation.

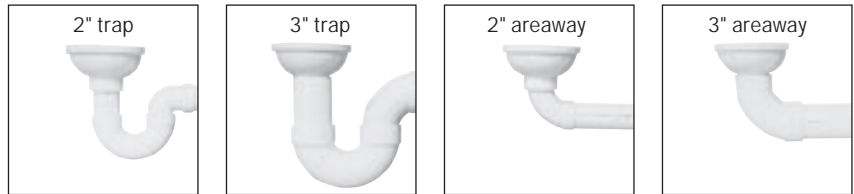

Adhesive debris cover protects drain during pour and removes with no residue.

Related Products	
Replacement Strainers	p 181
Grip Tip	p 229

Options: Add letter suffix. Add price to list.
H – 2" FIP threaded drain throat for stand pipe \$7.00

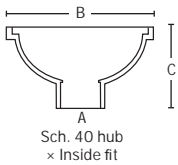

PVC Item No.	ABS Item No.	Dimensions			Min. Qty.	Case Qty.	List Price
		A	B	C			
WHITE OR BLACK POLYPRO STRAINER							
INDIVIDUALLY BAR-CODED IN A CUT CASE BOX							
841-2P	841-2A	2" x 3"	7½"	3¾"	12	12	10.75 EA
CAST NICKEL RING & STRAINER							
INDIVIDUALLY BAR-CODED BULK							
841-2PNR	841-2ANR	2" x 3"	7½"	3¾"	1	6	64.00 EA



3" x 4" Quad Drain™ General Purpose Floor Drain

- PVC solvent weld connection
- Outlet welds over 3" or inside 4" Sch. 40 pipe
- Custom fit your own P-trap or areaway drain
- Slab-Grab concrete stabilizing flange

Related Products	
Replacement Strainers	p 181
Grip Tip	p 229

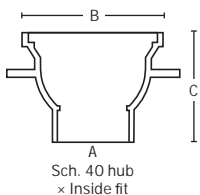

PVC Item No.	Dimensions			Min. Qty.	Case Qty.	List Price
	A	B	C			
PVC STRAINER						
INDIVIDUALLY BAR-CODED BULK						
841-3P	3" x 4"	6½"	4¾"	1	12	17.00 EA
CAST NICKEL RING & STRAINER						
INDIVIDUALLY BAR-CODED BULK						
841-3PNR	3" x 4"	6½"	4¾"	1	12	50.75 EA



SUPPLY

DRAINAGE

SUPPORT

TESTING

SPECIALTIES

TOOLS

ACCESS

Atlas Drain™ Full-Slip Floor Drain

- PVC solvent weld connection
- Drain connection is full slip—slips completely over 2" or 3" Sch. 40 pipe stub-up
- Slab-Grab concrete stabilizing flange

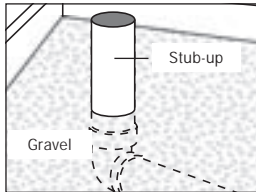

Stub up with Sch. 40 pipe prior to concrete pour.

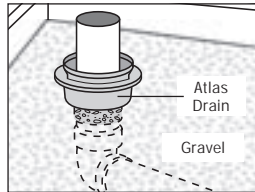

Flatwork contractor slips drain over stub-up and sets at desired level.

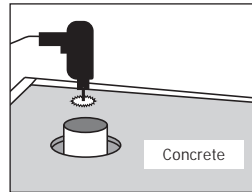

After concrete is set, cut stub-up off at bottom of sump area.



Related Products
Replacement Strainers p 181
Grip Tip p 229

Item No.	Dimensions			Min. Qty.	Case Qty.	List Price
	A	B	C			
PVC STRAINER LESS SCREWS						
INDIVIDUALLY BAR-CODED BULK						
841-29PL	2" full slip	6½"	4¾"	12	12	14.25 EA
841-39PL	3" full slip	6½"	4¾"	12	12	14.25 EA
PVC STRAINER WITH SCREWS						
INDIVIDUALLY BAR-CODED BULK						
841-29P	2" full slip	6½"	4¾"	12	12	16.25 EA
841-39P	3" full slip	6½"	4¾"	12	12	16.25 EA

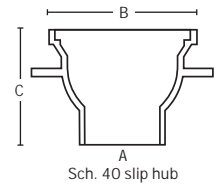

Inside Pipe Drain

- Solvent welds inside pipe, flush to floor
- Available one-piece or with stainless steel strainer
- Great for direct vent furnaces and water heaters, or to cover any open ended pipe

PVC Item No.	ABS Item No.	Dimensions			Min. Qty.	Case Qty.	List Price
		A	B	C			
ONE-PIECE DRAIN							
INDIVIDUALLY BAR-CODED BULK							
845-2P	—	2" Sch. 40	2¾"	1"	20	20	1.75 EA
845-3P	—	3" Sch. 40	3½"	1¾"	20	20	2.75 EA
845-330P	—	3" Sch. 30	3½"	1¾"	20	20	2.75 EA
845-4P	—	4" Sch. 40	4½"	1¾"	20	20	3.75 EA
INDIVIDUALLY BAR-CODED IN A CUT CASE BOX							
845-2PPK	845-2APK	2" Sch. 40	2¾"	1"	10	10	1.88 EA
845-3PPK	845-3APK	3" Sch. 40	3½"	1¾"	10	10	2.88 EA
845-4PPK	845-4APK	4" Sch. 40	4½"	1¾"	10	10	3.88 EA
DRAIN WITH STAINLESS STEEL STRAINER							
INDIVIDUALLY BAR-CODED BULK							
845-3PS	—	3" Sch. 40	3½"	1¾"	20	20	5.75 EA
845-330PS	—	3" Sch. 30	3½"	1¾"	20	20	5.50 EA
845-4PS	—	4" Sch. 40	4½"	1¾"	20	20	8.00 EA

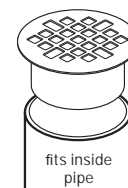

845-4P

845-4PS

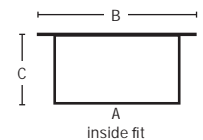



840-20P



840-27P



840-20PNR

Solvent Weld Floor Drain

Screw-on 18 Gauge Strainer with Machine Screws & Brass Inserts

- Machine screws and threaded brass inserts in drain body make strainer replacement fast and easy
- Hub × inside fit connection for versatility

Screw-on 18 Gauge Strainer with Standard Screws

- Standard screws thread into pilot holes in drain body
- Hub × inside fit connection for versatility

Snap-in 18 Gauge Strainer

- Strainer fingers grip slots in drain body to prevent slipping and turning
- Hub × inside fit connection for versatility

Cast Metal Ring & Strainer

- Machine screws and threaded brass inserts in drain body make strainer replacement fast and easy
- Hub × inside fit connection for versatility

Related Products
 Replacement Strainers p 182
 Grip Tip p 229

PVC Item No.	ABS Item No.	Dimensions			Strainer	Min. Qty.	Case Qty.	List Price
		A	B	C				
SCREW-ON 18 GAUGE W/ MACHINE SCREWS & BRASS INSERTS								
INDIVIDUALLY BAR-CODED BULK								
840-20P	840-20A	2" × 3"	4 ³ / ₈ "	2 ¹ / ₄ "	stainless	20	20	6.50 EA
840-30P	840-30A	3" × 4"	4 ³ / ₈ "	2 ¹ / ₄ "	stainless	1	20	8.50 EA
840-20PP	—	2" × 3"	4 ³ / ₈ "	2 ¹ / ₄ "	pol. brass - PVD	1	10	12.75 EA
SCREW-ON 18 GAUGE W/ STANDARD SCREWS								
INDIVIDUALLY BAR-CODED BULK								
840-2P	840-2A	2" × 3"	4 ³ / ₈ "	2 ¹ / ₄ "	stainless	20	20	5.00 EA
840-3P	840-3A	3" × 4"	4 ³ / ₈ "	2 ¹ / ₄ "	stainless	20	20	7.25 EA
840-2PP	—	2" × 3"	4 ³ / ₈ "	2 ¹ / ₄ "	pol. brass - PVD	1	10	13.50 EA
INDIVIDUALLY BAR-CODED IN A CUT CASE BOX								
840-2PPK	840-2APK	2" × 3"	4 ³ / ₈ "	2 ¹ / ₄ "	stainless	10	10	5.13 EA
840-3PPK	840-3APK	3" × 4"	4 ³ / ₈ "	2 ¹ / ₄ "	stainless	10	10	7.38 EA
SNAP-IN 18 GAUGE								
INDIVIDUALLY BAR-CODED BULK								
840-27P	840-27A	2" × 3"	4 ³ / ₈ "	2 ¹ / ₄ "	stainless	20	20	5.00 EA
840-37P	840-37A	3" × 4"	4 ³ / ₈ "	2 ¹ / ₄ "	stainless	1	10	8.25 EA
CAST METAL RING & STRAINER								
INDIVIDUALLY BAR-CODED BULK								
840-20PNR	840-20ANR	2" × 3"	4 ⁷ / ₁₆ "	2 ⁹ / ₁₆ "	cast nickel	1	10	26.50 EA
840-30PNR	840-30ANR	3" × 4"	4 ⁷ / ₁₆ "	2 ⁹ / ₁₆ "	cast nickel	1	10	27.50 EA
840-20PBR	840-20ABR	2" × 3"	4 ⁷ / ₁₆ "	2 ⁹ / ₁₆ "	cast brass	1	10	36.25 EA
840-30PBR	840-30ABR	3" × 4"	4 ⁷ / ₁₆ "	2 ⁹ / ₁₆ "	cast brass	1	10	37.25 EA

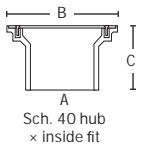

SUPPLY

DRAINAGE

SUPPORT

TESTING

SPECIALTIES

TOOLS

ACCESS

Gripper® Stainless Steel Pipe Strainer

- Gripping fingers fit snugly inside pipe keeping strainer securely in place
- Heavy gauge stainless steel—100% corrosion proof



Options: Add letter suffix. Add price to list.
C—Hole for condensate lines* \$1.25
 *C only available on 847-3 and 847-4.

Item No.	Description	Gauge	Min. Qty.	Case Qty.	List Price
BULK					
847-2	Inside pipe drain for 2" pipe	18	20	20	4.25 EA
847-3	Inside pipe drain for 3" pipe	16	20	20	4.50 EA
847-4	Inside pipe drain for 4" pipe	16	10	10	5.00 EA
BAR-CODED CLAMSHELLS IN A CUT CASE BOX					
847-2PK1	Inside pipe drain for 2" pipe	18	10	10	5.43 EA
847-3PK1	Inside pipe drain for 3" pipe	16	10	10	5.68 EA
847-4PK1	Inside pipe drain for 4" pipe	16	10	10	6.18 EA

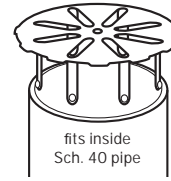

Replace-It™ Adjustable Drain Strainer

Patent # 4,871,451

- Replace rusted or broken cast iron strainers or bar grates
- Heavy gauge stainless steel—100% corrosion proof
- Adjustable screw clips to fit almost any drain
- 7 1/4" diameter fits 3 1/4" – 6 3/4" drain openings
- 9 1/4" diameter fits 5 1/4" – 8 3/4" drain openings

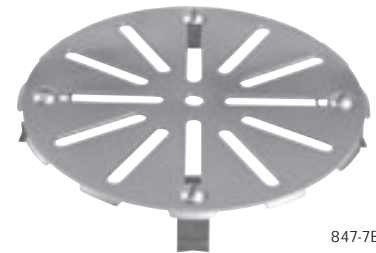

847-7B

Installation

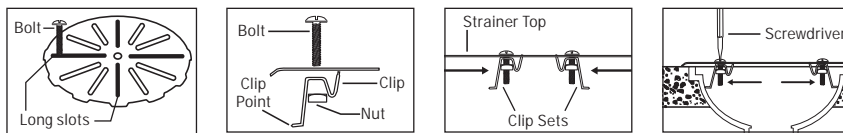

From the top of the strainer, insert bolt through one of the four long slots in the strainer.

Slip bolt through hole in clip, and loosely thread into the nut. Repeat for remaining three clip sets.

After assembly, slide all four clip sets toward the center of the strainer.

Install strainer in the drain opening. Slide the clip sets outward until they contact the drain. Tighten bolts.



847-7

Item No.	Description	Gauge	Min. Qty.	Case Qty.	List Price
INDIVIDUALLY BAR-CODED BULK					
847-7B	7 1/4" diameter Replace-It	14	20	20	17.25 BG
847-9	9 1/4" diameter Replace-It	12	1	10	50.00 BG
BAR-CODED CLAMSHELLS IN A CUT CASE BOX					
847-7	7 1/4" diameter Replace-It	14	10	10	22.00 EA



SUPPLY

DRAINAGE

SUPPORT

TESTING

SPECIALTIES

TOOLS

ACCESS



866-3P



866-3i

Bell Trap Drain

PVC

- Solvent weld connection
- Bell-type trap is designed into sump area

NEW Cast Iron

- No-hub connection
- Bell-type trap is designed into sump area

Related Products
Replacement strainers p 183

Item No.	Material	Dimensions			Min. Qty.	Case Qty.	List Price
		A	B	C			
INDIVIDUALLY BAR-CODED BULK							
866-2P	PVC	1 1/2" Sch. 40 hub x 2" Sch. 40 spigot	6"	2 3/16"	1	25	7.00 EA
866-3P	PVC	3" S & D hub x 3" Sch. 40 spigot	9"	4 1/2"	1	20	17.00 EA
866-34P	PVC	Over 3" or inside 4" Sch. 40	9"	4 1/2"	1	20	17.00 EA
866-4P	PVC	4" S & D hub x 4" Sch. 40 spigot	9"	4 1/2"	1	20	17.00 EA
866-2i	cast iron	2" no hub	5 3/4"	3 3/8"	2	2	26.00 EA
866-3i	cast iron	3" no hub	9"	4 3/8"	2	2	35.00 EA
INDIVIDUALLY BAR-CODED IN A CUT CASE BOX							
866-2PPK	PVC	1 1/2" Sch. 40 hub x 2" Sch. 40 spigot	6"	2 3/16"	5	5	8.20 EA
866-2APK	ABS	1 1/2" Sch. 40 hub x 2" Sch. 40 spigot	6"	2 3/16"	5	5	8.20 EA
866-34PPK	PVC	Over 3" or inside 4" Sch. 40	9"	4 1/2"	5	5	18.20 EA
866-34APK	ABS	Over 3" or inside 4" Sch. 40	9"	4 1/2"	5	5	18.20 EA

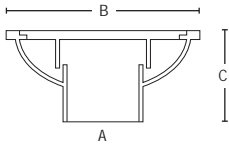

PVC Vent Cap

- Fits over 3" or 4" DWV pipe
- Two set screws secure cap to vent pipe

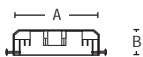

Item No.	Dimensions		Min. Qty.	Case Qty.	List Price
	A	B			
INDIVIDUALLY BAR-CODED IN A CUT CASE BOX					
869-V34	6"	1 3/4"	4	4	13.75 EA

Philadelphia Style Vent Cap

- Cast iron inside-caulk connection
- Set 2" above grade (or in accordance with local code)
- Install outside on sewer lateral to vent gas
- Enamel coated cast iron

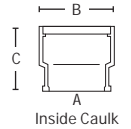

Related Products
Replacement strainers p 183

Item No.	Dimensions			Min. Qty.	Case Qty.	List Price
	A	B	C			
INDIVIDUALLY BAR-CODED BULK						
869-V4	4"	6 ⁵ / ₈ "	5 ⁵ / ₈ "	1	1	21.50 EA

SUPPLY

DRAINAGE

Pittsburgh Style Drain

- Cast iron inside-caulk connection
- Enamel coated cast iron

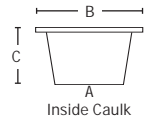

Related Products
Replacement strainers p 183

Item No.	Dimensions			Min. Qty.	Case Qty.	List Price
	A	B	C			
INDIVIDUALLY BAR-CODED BULK						
844-04iQ	4"	8 ³ / ₄ "	4 ⁵ / ₈ "	2	2	21.00 EA

SUPPORT

TESTING

St. Louis Style Drain

- Cast iron inside-caulk connection
- Enamel coated cast iron

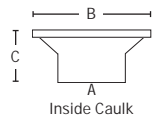

Related Products
Replacement strainers p 183

Item No.	Dimensions			Min. Qty.	Case Qty.	List Price
	A	B	C			
INDIVIDUALLY BAR-CODED IN A CUT CASE BOX						
844-02SL	2"	4 ⁷ / ₈ "	2 ³ / ₈ "	2	2	10.00 EA
844-0SL	3"	7"	3 ¹ / ₂ "	2	2	12.50 EA
844-04SL	4"	9 ¹ / ₄ "	4"	2	2	23.00 EA

SPECIALTIES

TOOLS

ACCESS

TKO™
Total Knockout Closet Flange

Patent #5,377,361

- Ten years of proven performance
- Knockout will not break apart and cannot fall down drain pipe
- Strong, corrosion-resistant stainless steel ring eliminates cracked flanges
- Easier installation, no need to hold knockout while hammering
- Holds five floors (22 PSI) for head test



Hit the raised rim of the TKO until the knockout cracks loose.

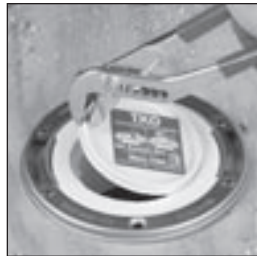

Remove loose knockout with pliers. It always removes in one piece.

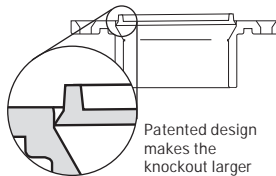

Patented design makes the knockout larger than the drain throat. The knockout falls down 1/8" and stays in one piece. It will not break apart and fall down drain line.



883-PT



886-4PT



884-PTM



888-PTM

	PVC Item No.	ABS Item No.	Connection	Min. Qty.	Case Qty.	List Price
ONE-PIECE PLASTIC RING						
INDIVIDUALLY BAR-CODED BULK						
	883-PT	883-AT	3" hub/inside 4", flush to floor*	25	25	3.40 EA
NEW	886-PTS	886-ATS	3" spigot	25	25	5.85 EA
NEW	886-PT30	—	3" Sch. 30 hub	25	25	3.80 EA
NEW	886-4PT	886-4AT	4" hub, flush to floor	25	25	5.85 EA
NEW	886-4PTS	886-4ATS	4" spigot, flush to floor	25	25	5.85 EA
INDIVIDUALLY BAR-CODED IN A CUT CASE BOX						
NEW	883-PTPK	883-ATPK	3" hub/inside 4", flush to floor*	8	8	3.54 EA
NEW	886-PTSPK	886-ATSPK	3" spigot	8	8	5.97 EA
NEW	886-4PTPK	886-4ATPK	4" hub, flush to floor	8	8	5.97 EA
NEW	886-4PTSPK	886-4ATSPK	4" spigot, flush to floor	8	8	5.97 EA
STAINLESS STEEL SWIVEL RING						
INDIVIDUALLY BAR-CODED BULK						
	884-PTM	884-ATM	3" hub/inside 4", flush to floor*	24	24	6.50 EA
NEW	886-PTMS	886-ATMS	3" spigot	25	25	11.44 EA
NEW	888-PTM	888-ATM	3" inside fit*	25	25	6.12 EA
NEW	886-PTM30	—	3" Sch. 30 hub	25	25	8.00 EA
NEW	886-4PTM	886-4ATM	4" hub, flush to floor	25	25	8.84 EA
NEW	886-4PTMS	886-4ATMS	4" spigot, flush to floor	25	25	8.84 EA
INDIVIDUALLY BAR-CODED IN A CUT CASE BOX						
NEW	884-PTMPK	884-ATMPK	3" hub/inside 4", flush to floor*	8	8	6.64 EA
NEW	886-PTMSPK	886-ATMSPK	3" spigot	8	8	11.56 EA
NEW	888-PTMPK	888-ATMPK	3" inside fit*	8	8	6.24 EA
NEW	886-PTM30PK	—	3" Sch. 30 hub	8	8	8.12 EA
NEW	886-4PTMPK	886-4ATMPK	4" hub, flush to floor	8	8	8.96 EA
NEW	886-4PTMSPK	886-4ATMSPK	4" spigot, flush to floor	8	8	8.96 EA

* The inside diameter of pipe can vary significantly. These flanges are designed to fit inside most, but may not fit all types of pipe.

SUPPLY

DRAINAGE

SUPPORT

TESTING

SPECIALTIES

TOOLS

ACCESS

Closet Flanges

SUPPLY

DRAINAGE

SUPPORT

TESTING

SPECIALTIES

TOOLS

ACCESS



887-GPM



887-GPTM

Push-Tite™ Gasketed Closet Flange

Patent Pending

- Gasket seals inside DWV pipe
- Strong, adjustable stainless steel swivel ring means you adjust the ring, not the flange. No chance of breaking gasket seal
- Engineered elastomer gasket is chemical and heat resistant
- Both models have larger flow-through areas than similar gasketed closet flange
- New TKO model holds 5 PSI for air test

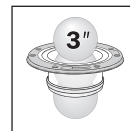

The 887 model Push-Tite is the only gasketed closet flange that will allow a 3" ball to pass with no obstructions

• Create Extension for 887 Push-Tite

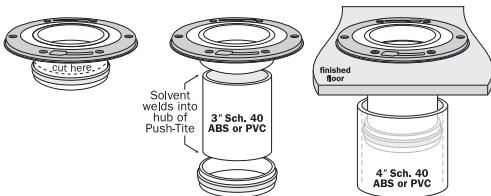

- 1 Cut the hub of the Push-Tite about half way between the gasket and the ring.
- 2 Solvent weld a piece of 3" Sch. 40 DWV pipe (length equal to the distance from 2" inside the drain pipe to the top edge of the finished floor) between both halves of the hub.
- 3 Push pipe/flange assembly fully down into 4" pipe and fasten the ring to the floor.

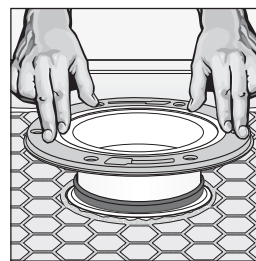

The Push-Tite fits flush-to-floor and installs into DWV pipe. The 887 models even glues over 3" PVC or ABS pipe if necessary. Lubricate the gasket before installation.

PVC Item No.	ABS Item No.	Connection	Min. Qty.	Case Qty.	List Price
OPEN FLANGE					
INDIVIDUALLY BAR-CODED IN A CUT CASE BOX					
NEW 888-GPM	—	gasketed 3" inside fit, 4" long tailpiece	6	6	25.24 EA
887-GPM	887-GAM	gasketed 4" inside fit, flush to floor	6	6	18.75 EA
WITH KNOCKOUT					
INDIVIDUALLY BAR-CODED IN A CUT CASE BOX					
887-GPTM	887-GATM	gasketed 4" inside fit, flush to floor	6	6	19.25 EA
NEW 887-GPTMK	—	Push-Tite Installation Kit: includes 887-GPTM, wax ring, closet bolts, shims	6	6	29.00 EA



Open Closet Flange

Stainless Steel Swivel Ring

- Corrosion-resistant stainless steel swivel ring is engineered for maximum strength

One-Piece Plastic

- Solid ABS or PVC



887-PM



886-4P

PVC Item No.	ABS Item No.	Connection	Min. Qty.	Case Qty.	List Price
ONE-PIECE PLASTIC RING					
INDIVIDUALLY BAR-CODED BULK					
888-P	888-A	3" inside fit*	20	20	3.75 EA
886-P	886-A	3" hub/inside 4", flush to floor*	20	20	3.00 EA
886-4P	886-4A	4" hub, flush to floor	25	25	4.83 EA
886-4PS	886-4AS	4" spigot, flush to floor	25	25	4.83 EA
INDIVIDUALLY BAR-CODED IN A CUT CASE BOX					
888-PPK	888-APK	3" inside fit*	10	10	3.88 EA
886-PPK	886-APK	3" hub/inside 4", flush to floor*	10	10	3.12 EA
886-4PPK	886-4APK	4" hub, flush to floor	6	6	4.95 EA
STAINLESS STEEL SWIVEL RING					
INDIVIDUALLY BAR-CODED BULK					
888-PM	888-AM	3" inside fit, 4" long tailpiece*	12	12	9.00 EA
887-PM	887-AM	3" hub/inside 4", flush to floor*	25	25	6.35 EA
886-4PM	886-4AM	4" hub, flush to floor	25	25	8.45 EA
886-4PMS	886-4AMS	4" spigot, flush to floor	25	25	8.45 EA
INDIVIDUALLY BAR-CODED IN A CUT CASE BOX					
886-4PMSPK	886-4AMSPK	4" spigot, flush to floor	6	6	8.57 EA

* The inside diameter of pipe can vary significantly. These flanges are designed to fit inside most, but may not fit all types of pipe.

Full Flush™ Offset Closet Flange

- Full-flow, 3" I.D. throat—no restriction
- Allows for 1½" offset in any direction for closet bowl setting
- Corrosion-resistant stainless steel swivel ring is engineered for maximum strength
- Solvent welds over 3" or inside 4" Sch. 40 DWV
- Fits flush-to-floor through any 4" opening
- UPC listed



Full Flush is the only offset closet flange that will allow a 3" ball to pass with no obstructions



PVC Item No.	ABS Item No.	Connection	Min. Qty.	Case Qty.	List Price
INDIVIDUALLY BAR-CODED BULK					
889-POM	889-AOM	3" hub/inside 4", flush to floor*	20	20	10.25 EA
INDIVIDUALLY BAR-CODED IN A CUT CASE BOX					
889-POMP	889-AOMP	3" hub/inside 4", flush to floor*	6	6	10.38 EA

* The inside diameter of pipe can vary significantly. These flanges are designed to fit inside most, but may not fit all types of pipe.

SUPPLY

DRAINAGE



Drop-Kick™ 45° Offset Closet Flange

- Full-flow, 3" I.D. throat—no restriction
- Solvent welds inside 3" Sch. 40 fitting hub
- Corrosion-resistant stainless steel swivel ring is engineered for maximum strength

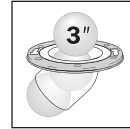

Drop-Kick is the only 45° offset closet flange that will allow a 3" ball to pass with no obstructions

PVC Item No.	ABS Item No.	Connection	Min. Qty.	Case Qty.	List Price
INDIVIDUALLY BAR-CODED BULK					
889-45PM	889-45AM	3" spigot, flush to floor	20	20	14.50 EA
INDIVIDUALLY BAR-CODED IN A CUT CASE BOX					
889-45PMPK	889-45AMPK	3" spigot, flush to floor	10	10	14.63 EA

SUPPORT

Cast Iron Closet Flange

- Fits over 4" cast iron DWV pipe
- Easy compression installation. Neoprene gasket
- Perfect for retrofit or remodel applications



Item No.	Connection	Min. Qty.	Case Qty.	List Price
BULK				
890-i42B	4" cast iron compression connection	500	500	11.00 EA
INDIVIDUALLY BAR-CODED BULK				
890-i42	4" cast iron compression connection	5	5	12.00 EA

TESTING

SPECIALTIES

Brass Closet Flange Ring

- Solid brass
- For use with lead pipe
- Deep seal model provides more surface area for better joint



890-4BPK



890-4BDPK

Item No.	Description	Min. Qty.	Case Qty.	List Price
INDIVIDUALLY BAR-CODED IN A CUT CASE BOX				
890-4BPK	Brass closet flange ring	10	10	10.75 EA
890-4BDPK	Deep seal brass closet flange ring	10	10	17.50 EA

TOOLS

ACCESS

Quick Spacer™ Closet Flange Spacer Ring

- Fits under most closet flanges
- Each ring raises the flange 3/4" off the floor
- Use multiple rings for additional height

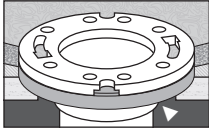

No more shim pieces
Fits under any closet flange and stops lightweight concrete pours from running under the flange.

Item No.	Description	Min. Qty.	Case Qty.	List Price
886-ER	3/4" closet flange spacer ring	25	25	2.00 EA



SUPPLY

DRAINAGE

Ringer™ Stainless Steel Closet Ring

- Stainless steel ring is corrosion resistant
- Perfect for repairs to damaged closet flanges, or new concrete floor installations
- Fits securely over damaged flanges



Packaged on attractive hanger card.

Item No.	Description	Min. Qty.	Case Qty.	List Price
BAR-CODED CARDS IN A CUT CASE BOX				
886-MR	Stainless steel closet ring	20	20	4.40 EA



SUPPORT

TESTING

Raise-A-Ring™ Flange Extension Ring

- Build up existing flange when added subfloor, tile, etc. leaves flange at or below floor level
- Ring is 7/16" thick. Can be stacked if needed



Packaged on attractive hanger card.

Item No.	Description	Min. Qty.	Case Qty.	List Price
BAR-CODED CARDS IN A CUT CASE BOX				
886-R	Flange extension ring	20	20	2.75 EA
BAR-CODED BAGS IN A CUT CASE BOX				
886-411	Raise-A-Ring Kit: 886-R with 2 closet bolts, 2 shims/bag	20	20	5.00 EA



SPECIALTIES

TOOLS

ACCESS

Urinal Flange Kit

- Kit includes: stainless steel bolts, nuts, washers, and gaskets
- Hub or spigot connections available
- Horizontal slots fit 3 1/2"–7" mounting centers



PVC Item No.	ABS Item No.	Description	Min. Qty.	Case Qty.	List Price
INDIVIDUALLY BAR-CODED BULK					
868-5P	868-5A	2" hub connection urinal flange kit	10	10	14.50 EA
868-9P	868-9A	2" spigot connection urinal flange kit	10	10	13.75 EA

Notes

SUPPLY

DRAINAGE

SUPPORT

TESTING

SPECIALTIES

TOOLS

ACCESS

DWV Backwater Valve

PVC or ABS Solvent Weld Connection

- Threaded access seals hand tight and allows for easy maintenance and inspection
- Allows unrestricted flow
- 6" backwater valve extensions—use 10" Sch. 40 pipe (not included)
- For GRAVITY FLOW applications only
- Do not install vertically
- CSA certified (B181.1 and B181.2)
- UPC/IAPMO listed



SUPPLY

DRAINAGE

SUPPORT

TESTING

SPECIALTIES

TOOLS

ACCESS

Item No.	Description	Dimensions			Min. Qty.	Case Qty.	List Price
		A	B	C			
BACKWATER VALVE							
INDIVIDUALLY BAR-CODED BULK							
869-2P	2" PVC valve	2.56"	2.5"	3.53"	1	8	30.00 EA
869-2A	2" ABS valve	2.56"	2.5"	3.53"	1	8	30.00 EA
869-3P	3" PVC valve	3.91"	3.65"	6.1"	4	4	33.00 EA
869-3PS	869-3P w/ 16" sleeve & lid	3.91"	3.65"	6.1"	1	1	50.00 EA
869-3A	3" ABS valve	3.91"	3.65"	6.1"	4	4	33.00 EA
869-3AS	869-3A w/ 16" sleeve & lid	3.91"	3.65"	6.1"	1	1	50.00 EA
869-4P	4" PVC valve	5.65"	5.62"	7.18"	6	6	42.00 EA
869-4PS	869-4P w/ 16" sleeve & lid	5.65"	5.62"	7.18"	1	1	66.50 EA
869-4A	4" ABS valve	5.65"	5.62"	7.18"	6	6	42.00 EA
869-4AS	869-4A w/ 16" sleeve & lid	5.65"	5.62"	7.18"	1	1	66.50 EA
869-6P	6" PVC valve	7.81"	7.5"	9.9"	1	1	147.00 EA
869-6A	6" ABS valve	7.81"	7.5"	9.9"	1	1	147.00 EA
INDIVIDUALLY BAR-CODED IN A CUT CASE BOX							
869-3PPK	3" PVC valve	3.91"	3.65"	6.1"	2	2	34.13 EA
869-4PPK	4" PVC valve	5.65"	5.62"	7.18"	2	2	43.13 EA
REPLACEMENT PARTS							
869-23	Extension sleeve kit for 2" valve includes sleeve, locking collar, and lid				1	1	45.00 EA
869-44	16" extension sleeve for 4" valve				1	1	41.75 EA
869-3A1	3" black ABS threaded lid				1	6	8.50 EA
869-3P1	3" white PVC threaded lid				1	10	8.50 EA
869-30	O-ring for 3" threaded lid				1	10	3.75 EA
869-31	Flapper and o-ring for 3" valve				1	10	7.00 EA
869-33	Extension sleeve lid for 3" valve				1	25	6.00 EA
869-34	16" extension sleeve for 3" valve				1	2	30.00 EA
869-36	Locking collar for 869-34 extension sleeve				1	10	11.25 EA
869-4A1	4" black ABS threaded lid				1	10	12.50 EA
869-4P1	4" white PVC threaded lid				1	10	12.50 EA
869-40	O-ring for 4" threaded lid				1	10	5.00 EA
869-41	Flapper and o-ring for 4" valve				1	10	9.00 EA
869-43	Extension sleeve lid for 4" valve				1	20	9.50 EA
869-46	Locking collar for 869-44 extension sleeve				1	10	14.00 EA
869-6A1	6" black ABS threaded lid				1	2	33.00 EA
869-6P1	6" white PVC threaded lid				1	2	33.00 EA
869-60	O-ring for 6" threaded lid				1	10	12.50 EA
869-61	Flapper and o-ring for 6" valve				1	10	22.50 EA
869-63	Extension sleeve lid for 6" valve				1	15	35.00 EA

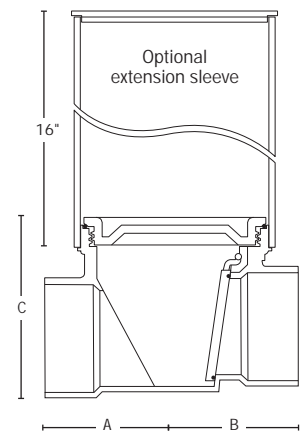

Extension sleeve is SDR 35 PVC
For extension sleeves on 6" backwater valves use 10" Sch. 40 pipe.



Drainage Accessories

SUPPLY

DRAINAGE

SUPPORT

TESTING

SPECIALTIES

TOOLS

ACCESS





Slotted Polypro Flush Plug

- With or without threaded brass insert
- Combine with FIP adapters to make your own cleanouts
- Glass-filled polypropylene plugs
 - Will not seize up on ABS or PVC
 - Are acid resistant and chemically inert
 - Are more durable than traditional plugs

SUPPLY

DRAINAGE

SUPPORT

TESTING

SPECIALTIES

TOOLS

ACCESS

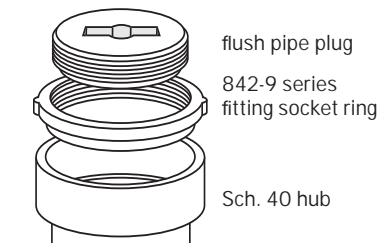

2"-4" plugs can be used with our 842-9 Series fitting socket rings for an inexpensive threaded access hole cover.



White Polypro Item No.	Black Polypro Item No.	Plug Size	Min. Qty.	Case Qty.	List Price
PLUGS WITH THREADED BRASS INSERT					
BULK					
878-15	879-15	1 1/2"	25	25	1.65 EA
878-20	879-20	2"	25	25	1.60 EA
878-25	879-25	2 1/2"	25	25	2.15 EA
878-30	879-30	3"	25	25	2.50 EA
878-35	879-35	3 1/2"	25	25	3.00 EA
878-40	879-40	4"	25	25	3.50 EA
878-50	879-50	5"	25	25	9.50 EA
878-60	879-60	6"	8	8	10.50 EA
INDIVIDUALLY BAR-CODED IN A CUT CASE BOX					
878-15PK	879-15PK	1 1/2"	25	25	1.78 EA
878-20PK	879-20PK	2"	25	25	1.73 EA
878-25PK	879-25PK	2 1/2"	25	25	2.28 EA
878-30PK	879-30PK	3"	25	25	2.63 EA
878-35PK	879-35PK	3 1/2"	25	25	3.13 EA
878-40PK	879-40PK	4"	25	25	3.63 EA
PLUGS WITHOUT THREADED BRASS INSERT					
BULK					
878-015	879-015	1 1/2"	25	25	1.00 EA
878-020	879-020	2"	25	25	1.05 EA
878-025	879-025	2 1/2"	25	25	1.30 EA
878-030	879-030	3"	25	25	1.45 EA
878-035	879-035	3 1/2"	25	25	1.85 EA
878-040	879-040	4"	25	25	2.15 EA
INDIVIDUALLY BAR-CODED IN A CUT CASE BOX					
878-015PK	879-015PK	1 1/2"	25	25	1.13 EA
878-020PK	879-020PK	2"	25	25	1.18 EA
878-025PK	879-025PK	2 1/2"	25	25	1.43 EA
878-030PK	879-030PK	3"	25	25	1.58 EA
878-035PK	879-035PK	3 1/2"	25	25	1.98 EA
878-040PK	879-040PK	4"	25	25	2.28 EA

5" and 6" plugs: white is PVC, black is ABS



Brass Flush Plug

- Combine with FIP adapters on pp 190–191 to make cleanouts or flush plug assemblies
- Square head models are Southern Code
- Brass construction for heavy duty applications

Options: Add letter suffix. Add price to list.
D—Drilled & Tapped ¼" × 20 \$12.00

Item No.	Plug Size	Min. Qty.	Case Qty.	List Price
SLOTTED STYLE				
BULK				
877-915	1 ½"	1	20	16.20 EA
877-920	2"	1	20	16.88 EA
877-925	2 ½"	1	20	25.00 EA
877-930	3"	1	20	21.00 EA
877-935	3 ½"	1	20	33.00 EA
877-940	4"	1	10	40.00 EA
877-950	5"	1	10	55.00 EA
877-960	6"	1	4	75.00 EA
RAISED SQUARE HEAD				
BULK				
876-15	1 ½"	20	20	2.85 EA
876-20	2"	20	20	3.85 EA
876-25	2 ½"	20	20	4.85 EA
876-30	3"	20	20	7.80 EA
876-35	3 ½"	20	20	9.45 EA
876-40	4"	20	20	10.85 EA
876-50	5"	1	10	19.95 EA
876-60	6"	1	4	22.55 EA
INDIVIDUALLY BAR-CODED IN A CUT CASE BOX				
876-10PK	1 ¼"	10	10	2.50 EA
876-15PK	1 ½"	10	10	2.97 EA
876-20PK	2"	10	10	3.97 EA
876-25PK	2 ½"	10	10	4.97 EA
876-30PK	3"	10	10	7.92 EA
876-35PK	3 ½"	10	10	9.57 EA
876-40PK	4"	10	10	10.97 EA
COUNTERSUNK SQUARE HEAD				
BULK				
877-20	2"	1	20	4.20 EA
877-25	2 ½"	1	20	5.05 EA
877-30	3"	1	20	7.85 EA
877-35	3 ½"	1	20	9.70 EA
877-40	4"	1	20	11.50 EA
877-60	6"	1	20	23.65 EA
INDIVIDUALLY BAR-CODED IN A CUT CASE BOX				
877-20PK	2"	10	10	4.32 EA
877-30PK	3"	10	10	7.97 EA
877-35PK	3 ½"	10	10	9.82 EA
877-40PK	4"	10	10	11.62 EA

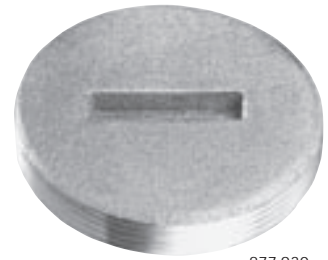

877-930

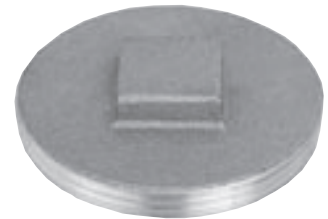

876-30



877-30

SUPPLY

DRAINAGE

SUPPORT

TESTING

SPECIALTIES

TOOLS

ACCESS



PVC Flush Plug—Spanner

Sch. 40 Thread

- Machined from solid PVC. Load limit 6,000+ lbs.

SDR 35 Thread

- Machined from solid PVC. Load limit 6,000+ lbs.

Options: Add letter suffix. Add price to list.
D—Drilled & Tapped ¼" × 20 \$12.00

Item No.	Plug Size	Min. Qty.	Case Qty.	List Price
SCH. 40 THREAD				
878-915	1½"	10	20	11.50 EA
878-920	2"	10	20	10.75 EA
878-925	2½"	10	20	11.50 EA
878-930	3"	10	20	10.50 EA
878-935	3½"	10	20	12.75 EA
878-940	4"	10	20	14.25 EA
878-950	5"	10	20	15.25 EA
878-960	6"	10	10	21.50 EA
878-980	8"	10	10	36.00 EA
SDR 35 THREAD				
878-740	4"	1	1	15.00 EA
878-760	6"	1	1	22.50 EA
878-780	8"	1	1	35.75 EA

Standard Adapter

FIP Thread × ABS or PVC Hub

- Combine these adapters with any of our 842-_L_ drains or 852-_L_ cleanout tops

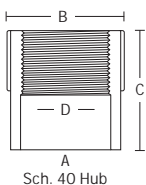

A Sch. 40 Hub



PVC Item No.	ABS Item No.	Dimensions				Min. Qty.	Case Qty.	List Price
		A	B	C	D			
INDIVIDUALLY BAR-CODED BULK								
842-72P	842-72A	2"	2¾"	2½"	2" FIP	5	5	2.50 EA
842-73P	842-73A	3"	4"	3¾"	3" FIP	5	5	5.50 EA
842-74P	842-74A	4"	5"	3¾"	4" FIP	10	10	7.75 EA
842-76P	842-76A	6"	6½"	5¾"	6" FIP	1	10	21.50 EA

SUPPLY

DRAINAGE

SUPPORT

TESTING

SPECIALTIES

TOOLS

ACCESS

Slab-Grab™ Adapter with Trap Primer Port FIPS Thread × ABS or PVC Hub

- ½" FIP tapped/plugged trap primer connection
- Combine these adapters with any of our 842-_L_ drains or 852-_L_ cleanout tops

PVC Item No.	ABS Item No.	Dimensions				Min. Qty.	Case Qty.	List Price
		A	B	C	D			
INDIVIDUALLY BAR-CODED BULK								
842-82PT	842-82AT	2"	4 ¹¹ / ₁₆ "	3 ³ / ₈ "	2" FIPS	1	10	8.25 EA
842-83PT	842-83AT	3"	6"	4"	3" FIPS	1	10	10.25 EA
842-84PT	842-84AT	4"	7"	4 ¹ / ₄ "	4" FIPS	1	10	11.75 EA

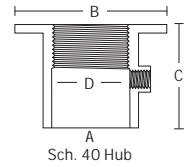

SUPPLY

DRAINAGE

Fitting Socket Adapter

- FIPS Thread × ABS or PVC Spigot
- Fits into Sch. 40 hub
 - Combine these adapters with any of our 842-_L_ drains or 852-_L_ cleanout tops

PVC Item No.	ABS Item No.	Dimensions				Min. Qty.	Case Qty.	List Price
		A	B	C	D			
BULK								
842-92P	842-92A	2"	2 ³ / ₄ "	½"	2" FIPS	10	20	2.75 EA
842-93P	842-93A	3"	4 ¹ / ₆ "	5/8"	3" FIPS	10	20	3.25 EA
842-94P	842-94A	4"	5 ¹ / ₆ "	5/8"	4" FIPS	10	20	3.50 EA

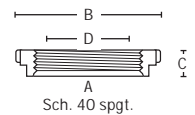

SUPPORT

TESTING

SPECIALTIES

Push-Joint Adapter

- FIP Thread × Cast Iron Push-Joint
- Neoprene push joint gasket
 - Combine these adapters with any of our 842-_L_ drains or 852-_L_ cleanout tops

Item No.	Dimensions				Min. Qty.	Case Qty.	List Price
	A	B	C	D			
INDIVIDUALLY BAR-CODED BULK							
858-62L	2"	2 ⁵ / ₈ "	4 ¹ / ₈ "	2" FIP	1	4	35.75 EA
858-63L	3"	3 ¹³ / ₁₆ "	4 ¹ / ₈ "	3" FIP	1	4	36.50 EA
858-64L	4"	4 ³ / ₈ "	4 ¹ / ₈ "	4" FIP	1	4	37.25 EA

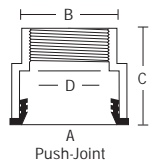
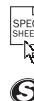

TOOLS

ACCESS

SUPPLY

DRAINAGE

SUPPORT

TESTING

SPECIALTIES

TOOLS

ACCESS

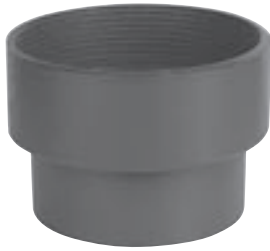

No-Hub Adapter

FIP Thread x Cast Iron No-Hub

- Combine these adapters with any of our 842-_L_ drains or 852-_L_ cleanout tops

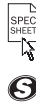
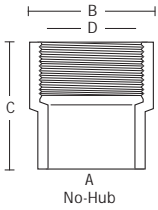

Item No.	Dimensions				Min. Qty.	Case Qty.	List Price
	A	B	C	D			
INDIVIDUALLY BAR-CODED BULK							
842-22i	2"	2¾"	3¼"	2" FIP	2	2	9.00 EA
842-23i	3"	4"	3¼"	3" FIP	2	2	11.50 EA
842-24i	4"	5"	3¼"	4" FIP	2	2	16.25 EA

Flashing Drain Adapter

FIPS Thread Collar with Flashing Drain Connection

- Choose the adapter that's right for you
 - Ductile iron collar with cast iron no-hub connection
 - PVC collar with ABS/PVC Sch. 40 hub connection
- Combine these adapters with any of our 842-_L_ drains or 852-_L_ cleanout tops
- PVC/ABS flashing adapter has threaded brass inserts for collar screws



Options: Add letter suffix. Add price to list.

D – Tapped/plugged trap primer port for ABS/PVC \$6.00

Note: All 863-HC series are factory tapped and plugged.

PVC Item No.	ABS Item No.	Dimensions				Min. Qty.	Case Qty.	List Price
		A	B	C	D			
PVC COLLAR – ABS OR PVC CONNECTION								
INDIVIDUALLY BAR-CODED BULK								
863-HP23	863-HA23	2"	8½"	3¾"	3" FIPS	1	10	24.50 EA
863-HP33	863-HA33	3"	8½"	3¾"	3" FIPS	1	10	24.50 EA
863-HP34	863-HA34	3"	8½"	3¾"	4" FIPS	1	10	24.50 EA
863-HP43	863-HA43	4"	8½"	3¾"	3" FIPS	1	10	24.50 EA
863-HP44	863-HA44	4"	8½"	3¾"	4" FIPS	1	10	24.50 EA
DUCTILE IRON COLLAR – CAST IRON NO-HUB CONNECTION								
INDIVIDUALLY BAR-CODED BULK								
863-HC223		2"	8½"	3¾"	3" FIPS	1	1	24.50 EA
863-HC233		3"	8½"	3¾"	3" FIPS	1	1	30.50 EA
863-HC234		3"	8½"	3¾"	4" FIPS	1	1	40.00 EA
863-HC243		4"	8½"	3¾"	3" FIPS	1	1	40.00 EA
863-HC244		4"	8½"	3¾"	4" FIPS	1	1	40.00 EA

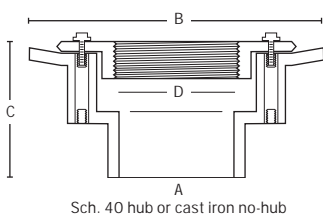

Replacement Strainer for Drains

Fits: 832 Series, 833 Series, 842 Series, 843 Series, 844 Series, 863 Series, Atlas Drain, 3" x 4" Quad Drain

Item No.	Diameter	Free Area (in ²)	Thickness	Screw Centers	Min. Qty.	Case Qty.	List Price
CAST NICKEL STRAINER WITH THREE STAINLESS SCREWS							
INDIVIDUALLY BAR-CODED BULK							
842-SN2	4"	3.85	3/16"	3"	1	1	17.75 EA
842-SN3	5 1/8"	6.84	3/16"	4"	1	1	21.00 EA
842-SN4	6 1/8"	9.57	3/16"	4 3/8"	1	1	24.75 EA
CAST BRASS STRAINER WITH THREE BRASS SCREWS							
INDIVIDUALLY BAR-CODED BULK							
842-SB2	4"	3.85	3/16"	3"	1	1	20.75 EA
842-SB3	5 1/8"	6.84	3/16"	4"	1	1	27.50 EA
842-SB4	6 1/8"	9.57	3/16"	4 3/8"	1	1	33.25 EA
GREY PVC STRAINER WITH THREE STAINLESS SCREWS							
INDIVIDUALLY BAR-CODED BULK							
842-SP2	4"	4.18	3/8"	3"	1	1	5.00 EA
842-SP3	5 1/16"	5.15	3/8"	4"	1	1	6.00 EA
842-SP4	6 1/16"	8.74	3/8"	4 3/8"	1	1	8.00 EA
STAINLESS STEEL STRAINER WITH THREE STAINLESS SCREWS*							
INDIVIDUALLY BAR-CODED BULK							
842-SS2	4"	2.66	18 gauge	3"	1	1	5.00 EA
842-SS3	5 1/16"	5.09	18 gauge	4"	1	1	6.00 EA
842-SS4	6 1/16"	9.25	16 gauge	4 3/8"	1	1	8.00 EA
CAST IRON STRAINER – LOOSE SET							
INDIVIDUALLY BAR-CODED BULK							
842-Si2	4 1/2"	4.18	3/16"	—	1	1	12.00 EA
842-Si3	5 5/8"	6.81	5/8"	—	1	1	15.00 EA
842-Si4	6 3/16"	9.58	5/8"	—	1	1	18.00 EA

* Stainless steel strainers for 843 series only.



842-SN4



842-SP4

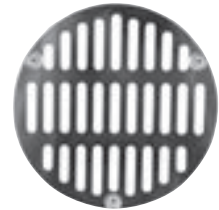

842-SS4

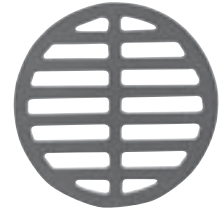

842-Si4

Replacement Strainer for Drains

Fits: Weld One, 2" x 3" Quad Drain

- Use 801-NER spacer ring when replacing poly strainers with cast nickel

Item No.	Diameter	Free Area (in ²)	Thickness	Screw Centers	Min. Qty.	Case Qty.	List Price
WHITE POLYPRO STRAINER WITH TWO STAINLESS SCREWS							
INDIVIDUALLY BAR-CODED BULK							
801-P	6 3/4"	6.6	3/8"	5 1/2"	1	1	4.96 EA
INDIVIDUALLY BAR-CODED IN A CUT CASE BOX							
801-PPK	6 3/4"	6.6	3/8"	5 1/2"	10	10	5.08 EA
BLACK POLYPRO STRAINER WITH TWO STAINLESS SCREWS							
INDIVIDUALLY BAR-CODED BULK							
801-A	6 3/4"	6.6	3/8"	5 1/2"	1	1	4.96 EA
INDIVIDUALLY BAR-CODED IN A CUT CASE BOX							
801-APK	6 3/4"	6.6	3/8"	5 1/2"	10	10	5.08 EA
CAST NICKEL STRAINER WITH TWO STAINLESS SCREWS							
INDIVIDUALLY BAR-CODED BULK							
801-N	6 3/4"	10.5	3/16"	5 1/2"	1	1	41.50 EA
SPACER RING FOR REPLACING POLY STRAINER							
INDIVIDUALLY BAR-CODED BULK							
801-NER	6 3/4"	10.5	3/16"	5 1/2"	1	1	12.50 EA

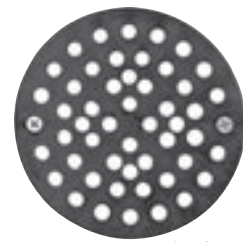

801-A

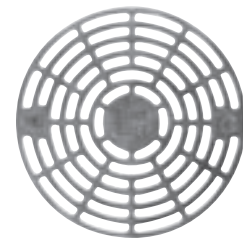

801-N



Replacement Strainer for Drains

Fits: 826 Series

Item No.	Finish	Diameter	Free Area (in ²)	Min. Qty.	Case Qty.	List Price
18 GAUGE STRAINER WITH SNAP-IN FINGERS						
826-2S	Stainless steel	4 1/4"	3.38	1	1	5.00 EA
826-2SP	Polished brass	4 1/4"	3.38	1	1	17.85 EA

Replacement Strainer for Drains

Fits: 821 Series, 825 Series, 827 Series, 828 Series, & 829 Series, 840 Series

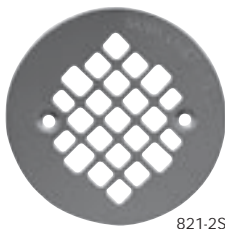

821-2S



827-2S



821-2SN

Item No.	Finish	Diameter	Free Area (in ²)	Screw Centers	Min. Qty.	Case Qty.	List Price
18 GAUGE STRAINER WITH TWO SCREWS							
INDIVIDUALLY BAR-CODED BULK							
821-2S	Stainless steel	4 1/4"	3.25	2 5/8"	1	1	2.75 EA
821-2SP	PVD brass	4 1/4"	3.25	2 5/8"	1	1	8.75 EA
821-2SW	White enamel	4 1/4"	3.25	2 5/8"	1	1	8.50 EA
821-2RB	Oil-rubbed bronze	4 1/4"	3.25	2 5/8"	1	1	28.00 EA
825-2AB	Antique brass	4 1/4"	3.25	2 5/8"	1	1	30.00 EA
825-2SC	Satin copper	4 1/4"	3.25	2 5/8"	1	1	30.00 EA
825-2SN	Satin nickel	4 1/4"	3.25	2 5/8"	1	1	30.00 EA
821-2SZ	Frosted stainless	4 1/4"	3.25	2 5/8"	1	1	4.75 EA
BAR-CODED CLAMSHELLS IN A CUT CASE BOX							
821-2SPK1	Stainless steel	4 1/4"	3.25	2 5/8"	10	10	3.93 EA
821-2SPPK1	PVD brass	4 1/4"	3.25	2 5/8"	10	10	9.93 EA
18 GAUGE STRAINER WITH SNAP-IN FINGERS							
INDIVIDUALLY BAR-CODED BULK							
827-2S	Stainless steel	4 1/4"	3.25	—	1	1	2.50 EA
827-2SP	PVD brass	4 1/4"	3.25	—	1	1	8.50 EA
827-2SW	White enamel	4 1/4"	3.25	—	1	1	8.00 EA
827-2SA	Bone enamel	4 1/4"	3.25	—	1	1	8.50 EA
827-2RB	Oil-rubbed bronze	4 1/4"	3.25	—	1	1	26.50 EA
827-2AB	Antique brass	4 1/4"	3.25	—	1	1	26.50 EA
827-2SC	Satin copper	4 1/4"	3.25	—	1	1	26.50 EA
827-2SN	Satin nickel	4 1/4"	3.25	—	1	1	26.50 EA
827-2SZ	Frosted stainless	4 1/4"	3.25	—	1	1	4.75 EA
BAR-CODED CLAMSHELLS IN A CUT CASE BOX							
827-2SPK1	Stainless steel	4 1/4"	3.25	—	10	10	3.68 EA
827-2SPPK1	PVD brass	4 1/4"	3.25	—	10	10	9.68 EA
827-2SWPK1	White enamel	4 1/4"	3.25	—	6	6	9.18 EA
827-2RBPk1	Oil-rubbed bronze	4 1/4"	3.25	—	6	6	27.68 EA
827-2ABPK1	Antique brass	4 1/4"	3.25	—	6	6	27.68 EA
827-2SNPK1	Satin nickel	4 1/4"	3.25	—	6	6	27.68 EA
CAST NICKEL STRAINER WITH TWO SCREWS							
INDIVIDUALLY BAR-CODED BULK							
821-2SN	Cast nickel	4"	3.85	2 5/8"	1	10	19.10 EA
821-2SRB	Oil-rubbed bronze	4"	3.85	2 5/8"	1	10	53.60 EA
BAR-CODED CLAMSHELLS IN A CUT CASE BOX							
821-2SNRPK1	Cast nickel ring & strainer	4"	3.85	2 5/8"	6	6	28.93 EA
821-2SRBRPK1	Cast ORB ring & strainer	4"	3.85	2 5/8"	6	6	67.68 EA
CAST BRASS STRAINER WITH TWO SCREWS							
INDIVIDUALLY BAR-CODED BULK							
821-2SB	Cast brass	4"	3.85	2 5/8"	1	10	18.50 EA

SUPPLY

DRAINAGE

SUPPORT

TESTING

SPECIALTIES

TOOLS

ACCESS

Replacement Strainer for Roof Drains

Fits: 867 Series, 868 Series

Item No.	Material	Bottom Diameter	Min. Qty.	Case Qty.	List Price
DOME STRAINER FOR 867 SERIES					
INDIVIDUALLY BAR-CODED BULK					
867-HD	Polypropylene	7½"	1	5	10.00 EA
867-MD	Cast iron	7½"	1	5	32.50 EA
DOME STRAINER FOR 868 SERIES*					
INDIVIDUALLY BAR-CODED BULK					
868-HD	Polyethylene	9¼"	1	5	16.00 EA
868-MD	Cast aluminum	9¼"	1	5	45.00 EA

* Strainers not for use with 8" roof drains.



SUPPLY

DRAINAGE

Replacement Strainer for Drains

Fits: 866 Series Bell Trap Drains

Item No.	Material	Drain Top Dimension	Strainer Diameter	Thickness	Min. Qty.	Case Qty.	List Price
INDIVIDUALLY BAR-CODED BULK							
866-2S	PVC	6"	4 ⁹ / ₁₆ "	3 ³ / ₈ "	1	20	6.25 ea
866-3S	PVC	9"	7 ³ / ₄ "	3 ³ / ₈ "	1	20	9.00 ea
866-S2i	Cast iron	6"	4 ⁷ / ₈ "	1 ¹ / ₈ "	2	2	7.00 ea
866-S3i	Cast iron	9"	6 ³ / ₄ "	5 ¹ / ₁₆ "	2	2	12.00 ea
INDIVIDUALLY BAR-CODED IN A CUT CASE BOX							
866-2SPK	PVC	6"	4 ⁹ / ₁₆ "	3 ³ / ₈ "	5	5	7.45 ea

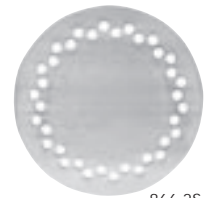

866-2S

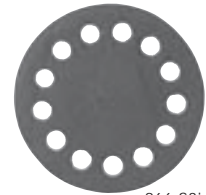

866-S3i

SUPPORT

TESTING

Replacement Strainer/Vent Cap for Drains

Fits: Pittsburgh Style Drain
St. Louis Style Drain
Philadelphia Style Vent Cap

Item No.	Material	Diameter	Free Area (in ²)	Thickness	Min. Qty.	Case Qty.	List Price
PITTSBURGH STYLE DRAIN – LOOSE SET							
INDIVIDUALLY BAR-CODED BULK							
844-S4	Epoxy coated cast iron	6¾"	7.13	3 ³ / ₈ "	1	1	6.50 EA
ST. LOUIS STYLE DRAIN – LOOSE SET							
INDIVIDUALLY BAR-CODED BULK							
844-O2G	Epoxy coated cast iron	4 ⁷ / ₁₆ "	4.54	3 ³ / ₈ "	1	10	5.00 EA
844-0G	Epoxy coated cast iron	6 ³ / ₈ "	6.50	3 ³ / ₈ "	1	10	7.00 EA
844-04G	Epoxy coated cast iron	8 ⁵ / ₈ "	11.00	3 ³ / ₈ "	1	10	15.00 EA
PHILADELPHIA STYLE VENT CAP							
INDIVIDUALLY BAR-CODED BULK							
869-SV4	Epoxy coated with set screw	6"	—	1 ¹ / ₁₆ "	1	1	12.50 EA

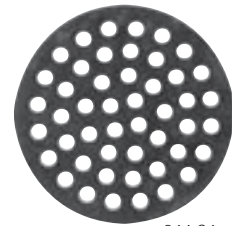

844-S4

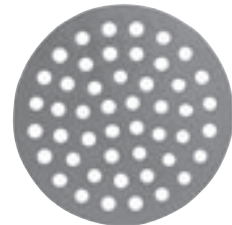

844-O2G



869-SV4

SPECIALTIES

TOOLS

ACCESS

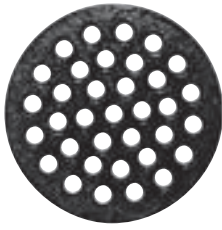

Cast Iron Strainer

General Purpose

- Epoxy coated for corrosion resistance

Item No.	Diameter	Thickness	Min. Qty.	Case Qty.	List Price
INDIVIDUALLY BAR-CODED IN A CUT CASE BOX					
846-S1PK	4½"	¼"	6	6	3.25 EA
846-S3PK	5"	¼"	6	6	3.75 EA
846-S5PK	6"	¼"	6	6	5.50 EA
846-S7PK	6¼"	¼"	6	6	6.00 EA
846-S9PK	6½"	¼"	6	6	6.50 EA
846-S11PK	6⅝"	¼"	6	6	7.00 EA
846-S13PK	6¾"	¼"	6	6	7.50 EA
846-S15PK	7"	¼"	6	6	8.00 EA
846-S17PK	8"	¼"	6	6	10.00 EA
846-S19PK	9"	⅝"	6	6	14.00 EA

Replacement Covers for Cleanouts

Fits: 834 Series, 852 Series

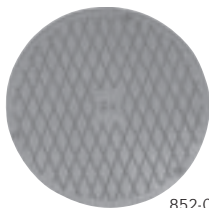

852-CN4

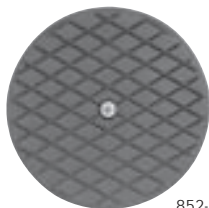

852-Ci4

Item No.	Diameter	Thickness	Screw Centers	Min. Qty.	Case Qty.	List Price
CAST NICKEL COVER WITH THREE STAINLESS SCREWS						
INDIVIDUALLY BAR-CODED BULK						
852-CN2	4"	⅜"	3"	1	1	30.65 EA
852-CN3	5½"	⅜"	4"	1	1	35.25 EA
852-CN4	6½"	⅜"	4⅜"	1	1	43.00 EA
CAST BRASS COVER WITH THREE BRASS SCREWS						
INDIVIDUALLY BAR-CODED BULK						
852-CB2	4"	⅜"	3"	1	1	33.50 EA
852-CB3	5½"	⅜"	4"	1	1	41.50 EA
852-CB4	6½"	⅜"	4⅜"	1	1	51.50 EA
TENZALLOY COVER WITH THREE STAINLESS SCREWS						
INDIVIDUALLY BAR-CODED BULK						
852-CT2	4"	⅜"	3"	1	1	18.50 EA
852-CT3	5½"	⅜"	4"	1	1	20.50 EA
852-CT4	6½"	⅜"	4⅜"	1	1	23.50 EA
PVC COVER WITH THREE STAINLESS SCREWS						
INDIVIDUALLY BAR-CODED BULK						
852-CP2	4"	⅜"	3"	1	1	6.50 EA
852-CP3	5½"	⅜"	4"	1	1	8.50 EA
852-CP4	6½"	⅜"	4⅜"	1	1	11.00 EA
CAST IRON COVER WITH THREE STAINLESS SCREWS						
INDIVIDUALLY BAR-CODED BULK						
852-Ci2	4½"	⅝"	—	1	1	15.50 EA
852-Ci3	5⅝"	⅝"	—	1	1	17.00 EA
852-Ci4	6¾"	⅝"	—	1	1	25.00 EA



Replacement Covers for Cleanouts

Fits: 851 Series

Options: Add letter suffix. Add price to list.
B – Beveled edge for floor plate* \$5.00
 *B is not available on cast iron covers.

Item No.	Diameter	Thickness	Min. Qty.	Case Qty.	List Price
CAST NICKEL COVER WITH ONE 1½" STAINLESS SCREW					
INDIVIDUALLY BAR-CODED BULK					
851-CN3	5½"	3/16"	1	1	48.00 EA
851-CN4	6½"	3/16"	1	1	58.00 EA
851-CN6	7¾"	3/16"	1	1	78.00 EA
851-CN8	8¾"	3/16"	1	1	97.75 EA
TENZALLOY COVER WITH ONE 1½" STAINLESS SCREW					
INDIVIDUALLY BAR-CODED BULK					
851-CT3	5½"	3/16"	1	1	25.75 EA
851-CT4	6½"	3/16"	1	1	34.50 EA
851-CT6	7¾"	3/16"	1	10	42.25 EA
851-CT8	8¾"	3/16"	1	1	55.25 EA
CAST IRON COVER WITH ONE 1½" STAINLESS SCREW					
INDIVIDUALLY BAR-CODED BULK					
851-Ci3	4½"	5/8"	1	1	16.00 EA
851-Ci4	5½"	5/8"	1	1	17.50 EA
851-Ci6	6½"	5/8"	1	1	23.00 EA
851-Ci8	7½"	5/8"	1	1	25.00 EA

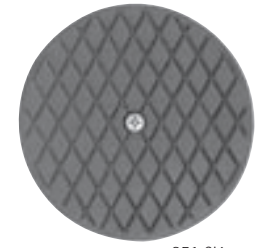
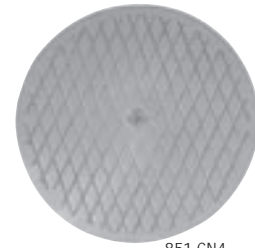

SUPPLY

DRAINAGE

SUPPORT

TESTING

Replacement Covers for Cleanouts

Fits: 850 Series

Item No.	Diameter	Thickness	Screw Centers	Min. Qty.	Case Qty.	List Price
CAST NICKEL COVER WITH THREE STAINLESS SCREW						
INDIVIDUALLY BAR-CODED BULK						
850-CN2	6½"	3/16"	4¾"	1	1	47.50 EA
850-CN3	6¾"	3/16"	5½"	1	1	60.00 EA
850-CN4	8¾"	3/16"	6¾"	1	1	93.25 EA
TENZALLOY COVER WITH THREE STAINLESS SCREW						
INDIVIDUALLY BAR-CODED BULK						
850-CT2	6½"	3/16"	4¾"	1	1	21.00 EA
850-CT3	6¾"	3/16"	5½"	1	1	36.80 EA
850-CT4	8¾"	3/16"	6¾"	1	1	58.10 EA
CAST IRON COVER WITH TWO STAINLESS SCREW						
INDIVIDUALLY BAR-CODED BULK						
850-Ci2	5¾"	5/8"	—	1	1	17.25 EA
850-Ci3	6¾"	5/8"	—	1	1	21.00 EA
850-Ci4	7¾"	5/8"	—	1	1	25.00 EA

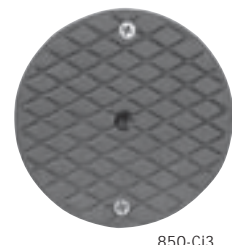
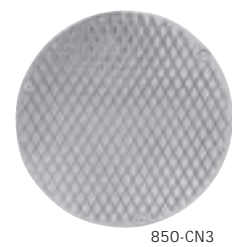

SPECIALTIES

TOOLS

ACCESS

Bits For Vandal-Resistant Screws



850-VW8



850-VW1



850-VW4

- Snake-eye pattern
- Fits ¼" hex sockets

Item No.	Span	For Vandal-Resistant Screws on Drain Series	Min. Qty.	Case Qty.	List Price
850-VW8	#8 span	827	10	10	15.00 EA
850-VW1	#10 span	842, 852, 860, 863, 867	10	10	15.00 EA
850-VW4	#14 span	850, 851	10	10	15.00 EA



Pipe Bore Adapter

- Extruded flexible PVC adapter connects any 6" nominal bore to 4" iron or plastic pipe

Item No.	Description	Min. Qty.	Case Qty.	List Price
880	4" to 6" rolling O-ring adapter	25	25	5.75 EA

Condensate Trap

P Trap or Running Trap

- One piece ¾" schedule 40 PVC trap saves fittings and job costs when trapping coil condenser lines

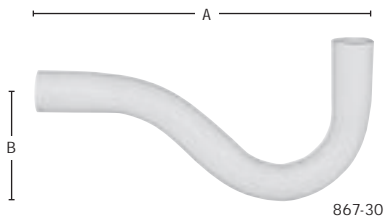

867-30

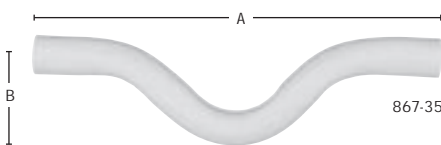

867-35

Item No.	Description	Dimensions		Min. Qty.	Case Qty.	List Price
		A	B			
BULK						
867-30	P trap	8"	2½"	50	50	3.10 EA
867-35	Running trap	10¾"	2"	25	25	3.10 EA
INDIVIDUALLY BAR-CODED IN A CUT CASE BOX						
867-30PK	P trap	8"	2½"	25	25	3.22 EA
867-35PK	Running trap	10¾"	2"	25	25	3.22 EA

Backup Float Valve

- Insert valve into pipe below drain and tighten screws



Item No.	Description	Min. Qty.	Case Qty.	List Price
BAR-CODED BAGS IN A CUT CASE BOX				
803-2PK2	2" Backup float valve	12	12	33.75 EA
803-3PK2	3" Backup float valve	12	12	22.50 EA
803-4PK2	4" Backup float valve	12	12	25.00 EA

Smart Saddle™ DWV Saddle Tee Fitting

- Compact design is perfect when DWV stacks are close to walls or other obstructions
- Stainless steel bands take up less room than V-bolts or U-bolts, and provide even torque, eliminating stress points which can damage pipe and create a poor seal
- Corrosion resistant

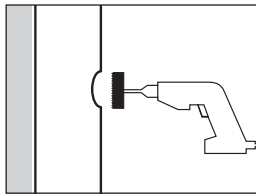

Cut a hole in stack that matches the I.D. of the inlet branch I.D. on the Smart Saddle.

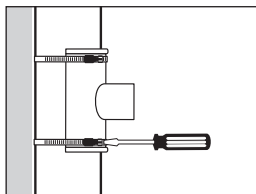

Apply glue, (or silicone for cast iron stacks) align holes on stack and inlet branch, and install stainless steel bands.

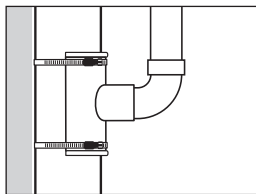

Glue appropriate pipe or fitting to the inlet branch.



PVC Item No.	ABS Item No.	Trunk	Inlet Branch	Min. Qty.	Case Qty.	List Price
BAR-CODED BAGS IN A CUT CASE BOX						
891-0312P	891-0312A	3" Sch. 40 trunk	1½" hub × 2" spigot	5	5	13.00 EA
891-033P	—	3" Sch. 40 trunk	3" hub × 4" inside fit	5	5	13.75 EA
891-0412P	891-0412A	4" Sch. 40 trunk	1½" hub × 2" spigot	5	5	14.00 EA
891-043P	—	4" Sch. 40 trunk	3" hub × 4" inside fit	5	5	15.00 EA
891-044P	—	4" Sch. 40 trunk	4" hub	5	5	15.50 EA



CATALOG 2007

Support

Supply Hangers
DWV Hangers
Brackets



Support

SUPPLY HANGERS

- 191 Suspensulator™
- 191 Pipe Eye™
- 192 Tube Talon™
- 192 Twin Talon™
- 193 Pick-Up Talon™
- 194 Sioux Strap™
- 194 PadLock™
- 195 TouchDown™
- 196 TouchDown II™
- 197 TouchDown™ with Beam Clamp
- 197 TouchDown II™ with Beam Clamp
- 197 TouchDown II™ with Strut Clamp
- 197 Suspension Clamp
- 198 Tube Insulator
- 198 Tube Clamp
- 198 Vinyl-Coated Steel Clamp with Screw
- 199 2-Hole Tube Strap
- 200 Drive Hook
- 200 Wire Pipe Hook
- 201 Wire Pipe Hook
- 201 CTS Bell Hanger
- 202 Cable Tie
- 202 Anchor Screw Kit
- 202 Tube Strap Nail
- 203 Clevis Hanger
- 203 Split Ring Hanger
- 204 3/8" All Thread Rod
- 204 Beam Clamp
- 204 Top Plate Connector
- 204 Side Beam Connector
- 205 Milford Hanger
- 205 Natick Hanger
- 205 Hangs Tuff Jr.™

DWV HANGERS

- 206 Hangs Tuff™
- 207 ZipStick™
- 207 ZipStrap™
- 208 Stick-Em Up™
- 208 Tomahawk™
- 209 DWV Hanger
- 209 Hanger Strap

BRACKETS

- 210–211 Universal Slider Bracket™
- 212–213 Power Bar™
- 214 Edge™
- 214 Support Bracket
- 214 Slider™
- 215 Stub Out Bracket
- 215 Secure-All™
- 216 Stub Out Bracket with Stud Guard
- 216 Pipe Eye Suspension Bracket™
- 216 Saddle-Up™
- 217 Carrier Bracket
- 217 Positioning Bracket
- 217 Chase Bracket
- 218 Pipe Titan™
- 219 Grid Iron™
- 220 SideWinder™
- 220 Square O Strap™
- 220 Solder Strap™
- 220 Copper Star™
- 221 Chieftain Ell Clamp™
- 221 Stud Shoe
- 222 Stud Guard
- 222 Shield Plate

SUPPLY

DRAINAGE

SUPPORT

TESTING

SPECIALTIES

TOOLS

ACCESS

Suspensulator™ Tube Suspension Clamp & Insulator

- Designed to work in both 1 3/8" or 1 11/32" holes in wood or metal studs
- For use with any CTS pipe (copper, PEX, CPVC, PB)
- Side fins lock perfectly into I-joist knockout
- Split design allows for use after piping is run
- Durable, U.V. resistant, high density polyethylene is 100% corrosion proof and reduces noise due to expansion and contraction in hot water lines

Related Products

Pipe Eye Suspension Bracket p 216

Item No.	Description	Min. Qty.	Case Qty.	List Price
BULK				
558-E1	3/8" CTS, grey	50	500	0.35 EA
558-E2	1/2" CTS, black	50	500	0.26 EA
558-E3	3/4" CTS, black	50	500	0.27 EA
558-E4	1" CTS, black	25	250	0.37 EA
BAR-CODED BAGS IN A CUT CASE BOX				
558-E2PK2	1/2" CTS, 5/bag	10	10	1.60 BG
558-E3PK2	3/4" CTS, 5/bag	10	10	1.65 BG
558-E4PK2	1" CTS, 5/bag	10	10	2.25 BG



Suspend



Insulate

Specifications

Material	U.V. protected high density polyethylene
Impact Resistance	to 0°F (-18°C)
Maximum Temperature	160°F (71°C) continuous

Pipe Eye™ Metal Stud Insulator

- Fits 1 11/32" holes in metal studs or brackets
- Split design. Offset hole for adjustable tube position
- Reduces expansion/contraction noise in hot water lines
- Fire retardant models are UL94 V-2 fire rated polypropylene
- Plenum safe models meet ASTM E84 25/50 and UL94 V-0 fire rating

Related Products

Pipe Eye Suspension Bracket p 216

Item No.	Description	Min. Qty.	Case Qty.	List Price
STANDARD				
558-M2	1/2" CTS	100	1000	0.22 EA
558-M3	3/4" CTS	100	1000	0.24 EA
558-M4	1" CTS	25	250	0.28 EA
GLUEABLE				
NEW 558-M2G	1/2" CTS	100	1000	0.22 EA
NEW 558-M3G	3/4" CTS	100	1000	0.24 EA
NEW 558-M4G	1" CTS	25	250	0.28 EA
FIRE RETARDANT				
558-M2R	1/2" CTS	100	1000	0.27 EA
558-M3R	3/4" CTS	100	1000	0.30 EA
558-M4R	1" CTS	25	250	0.33 EA
FIRE FIGHTER E84 PLENUM-SAFE				
558FM2	1/2" CTS	10	100	1.20 EA
558FM3	3/4" CTS	10	100	1.30 EA
558FM4	1" CTS	5	25	1.40 EA



Except glueable models



558-M2



558-M2G



558-M2R



558FM2

Specifications

	Material	Rating	Impact Resistance	Maximum Temp
Standard	U.V. protected high density polyethylene	—	to 0°F (-18°C)	160°F (71°C) continuous
Glueable	ABS	—		
Fire Retardant	Flame retardant polypropylene	UL94 V-2		
E84	Polyvinylidene Fluoride (PVDF)	ASTM E84 25/50 UL94 V-0		

*Only recommended when used in metal stud or metal bracket with 1 11/32" hole

Supply Hangers

CATALOG 2007



Tube Talons snap onto any CTS piping. Preloaded ring-shank nails assure a permanent hold and provide for "hands free" installation.

Specifications

Nail	Zinc coated ring-shank
Hanger Material	U.V. protected high density polyethylene
Impact Resistance	to 0°F (-18°C)
Maximum Temperature	160°F (71°C) continuous

Tube Talon™ Drive Hook

- Absorbs vibration to keep pipe quiet
- Tube is not damaged if nail is over driven
- Install in alternating directions to ensure secure piping
- For IPS piping (PVC and iron pipe) use next larger size Tube Talon
- Nails are preloaded

Item No.	Description	Min. Qty.	Case Qty.	List Price
BULK				
555-1	3/8" CTS with nail	100	1000	0.13 EA
555-2	1/2" CTS with nail	100	1000	0.075 EA
555-3	3/4" CTS with nail	100	1000	0.113 EA
555-4	1" CTS with nail	50	500	0.32 EA
BULK BUCKET				
555-2BK	1/2" CTS with nail, 1,800/bucket	1	1	135.00 BK
555-3BK	3/4" CTS with nail, 1,000/bucket	1	1	113.00 BK
555-4BK	1" CTS with nail, 500/bucket	1	1	160.00 BK



SUPPLY

DRAINAGE

SUPPORT

TESTING

SPECIALTIES

TOOLS

ACCESS



Twin Talon™ Double-Duty Drive Hook

Patent # 5,054,741

- 555-23 series affixes 1/2", 5/8", and 3/4" CTS nominal tube (copper or plastic) and 1/2" Sch. 40 IPS pipe (steel or plastic)
- 555-45 series affixes 1" and 1 1/4" CTS nominal tube (copper or plastic) and 3/4" and 1" Sch. 40 IPS pipe (steel or plastic)
- Available with shorter nail for radiant heat, nail-up applications. 1 5/8" nail won't penetrate 3/4" floors
- Ideal for flexible gas tube

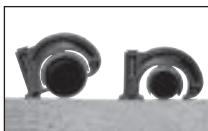

Fingers grab and hold tube for "hands free" installation.

Specifications

Nail	Zinc coated ring-shank
Screws	#6 x 1 3/4" Phillips pan head, self-drilling tip #6 x 2" Phillips pan head, self-drilling tip
Hanger Material	U.V. protected high density polyethylene
Impact Resistance	to 0°F (-18°C)
Maximum Temperature	160°F (71°C) continuous



Twin Talon™ Double-Duty Drive Hook

Item No.	Description	Min. Qty.	Case Qty.	List Price
BULK				
555-23	1/2"-3/4" CTS with nail	100	1000	0.125 EA
555-23S	1/2"-3/4" CTS with 1 3/4" screw	100	1000	0.28 EA
555-623	1/2"-3/4" CTS with shorter 1 5/8" nail	100	1000	0.17 EA
555-45	3/4" IPS-1 1/4" CTS with nail	25	100	0.48 EA
555-45S	3/4" IPS-1 1/4" CTS with screw	25	100	0.64 EA
BAR-CODED BAGS IN A CUT CASE BOX				
555-23PK2	1/2"-3/4" CTS with nail, 10/bag	10	10	1.60 BG
BULK BUCKET				
555-23BK	1/2"-3/4" CTS with nail, 850/bucket	1	1	106.25 BK
555-45BK	3/4" IPS-1 1/4" CTS with nail, 350/bucket	1	1	168.00 BK



Pick-Up Talon™ Isolating Drive Hook

Patent Pending

- The most affordable solution to keeping tube off the mounting surface
- Installation is fast and easy; snaps onto tube with preloaded nails or screws
- Install in alternating directions to ensure secure piping

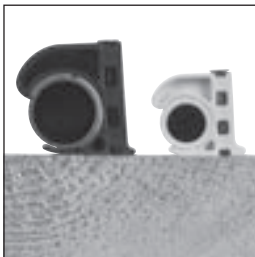

Protects tube from abrasive mounting surface and eliminates ticking noises.



Snaps and rolls easily onto CTS tubing.

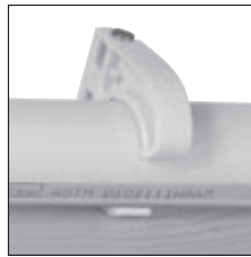

Ivory colored models match CPVC tube.



556-3S



556-3C



556-3PK4

Item No.	Description	Min. Qty.	Case Qty.	List Price
BLACK BULK				
556-1	3/8" CTS with nail	100	1000	0.13 EA
556-2	1/2" CTS with nail	100	1000	0.075 EA
556-2S	1/2" CTS with screw	100	1000	0.24 EA
556-3	3/4" CTS with nail	100	1000	0.113 EA
556-3S	3/4" CTS with screw	100	1000	0.27 EA
556-4	1" CTS with nail	50	500	0.32 EA
BAR-CODED BAGS IN A CUT CASE BOX				
556-2PK2	1/2" CTS with nail, 10/bag	10	10	1.14 BG
556-2PK3	1/2" CTS with nail, 100/bag	10	10	7.60 BG
556-3PK2	3/4" CTS with nail, 10/bag	10	10	1.55 BG
556-3PK3	3/4" CTS with nail, 100/bag	10	10	11.40 BG
556-4PK3	1" CTS with nail, 50/bag	10	10	16.05 BG
BAR-CODED BAGS IN A BAR-CODED DISPENSER BOX				
556-2PK4	1/2" CTS with nail, 10/bag, 20 bg/box	1	1	27.50 BX
556-3PK4	3/4" CTS with nail, 10/bag, 15 bg/box	1	1	27.50 BX
BULK BUCKET				
556-1BK	3/8" CTS with nail, 2,300/bucket	1	1	299.00 BK
556-2BK	1/2" CTS with nail, 1,600/bucket	1	1	120.00 BK
556-3BK	3/4" CTS with nail, 800/bucket	1	1	90.40 BK
556-4BK	1" CTS with nail, 400/bucket	1	1	128.00 BK
IVORY BULK				
556-1C	3/8" CTS with nail	100	1000	0.13 EA
556-2C	1/2" CTS with nail	100	1000	0.075 EA
556-3C	3/4" CTS with nail	100	1000	0.113 EA
556-4C	1" CTS with nail	50	500	0.32 EA
BAR-CODED BAGS IN A BAR-CODED DISPENSER BOX				
556-2CPK4	1/2" CTS with nail, 10/bag, 20 bg/box	1	1	27.50 BX
556-3CPK4	3/4" CTS with nail, 10/bag, 15 bg/box	1	1	27.50 BX
BULK BUCKET				
556-2CBK	1/2" CTS with nail, 1,600/bucket	1	1	120.00 BK
556-3CBK	3/4" CTS with nail, 800/bucket	1	1	90.40 BK
556-4CBK	1" CTS with nail, 400/bucket	1	1	128.00 BK

Specifications

Nail	Zinc coated ring-shank
Screws	#6 x 1 1/4" Phillips pan head, self-drilling tip #6 x 2" Phillips pan head, self-drilling tip
Hanger Material	U.V. protected high density polyethylene
Impact Resistance	to 0°F (-18°C)
Maximum Temperature	160°F (71°C) continuous



Supply Hangers

SUPPLY

DRAINAGE

SUPPORT

TESTING

SPECIALTIES

TOOLS

ACCESS

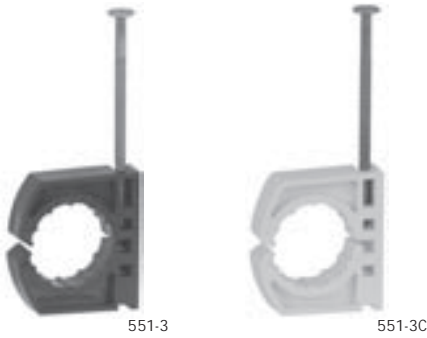

Insulates and isolates the tube from the mounting surface, reducing noise transfer and heat loss.

Specifications

Nail	Zinc coated ring-shank
Hanger Material	U.V. protected high density polyethylene
Impact Resistance	to 0°F (-18°C)
Maximum Temperature	160°F (71°C) continuous



Sioux Strap™ Tube Hanger

- Preloaded ring-shank nail assures a permanent hold
- Snaps onto tube for "hands free" installation
- Provides ¼" standoff

Item No.	Description	Min. Qty.	Case Qty.	List Price
BLACK				
BULK				
551-2	½" CTS with nail	100	1000	0.13 EA
551-3	¾" CTS with nail	50	500	0.17 EA
551-4	1" CTS with nail	25	250	0.48 EA
BULK BUCKET				
551-2BK	½" CTS with nail, 1,000/bucket	1	1	130.06 BK
551-3BK	¾" CTS with nail, 600/bucket	1	1	102.04 BK
551-4BK	1" CTS with nail, 350/bucket	1	1	168.00 BK
IVORY				
BULK				
551-2C	½" CTS with nail	100	1000	0.13 EA
551-3C	¾" CTS with nail	50	500	0.17 EA
551-4C	1" CTS with nail	25	250	0.48 EA
BULK BUCKET				
551-2CBK	½" CTS with nail, 1,000/bucket	1	1	130.06 BK
551-3CBK	¾" CTS with nail, 600/bucket	1	1	102.04 BK
551-4CBK	1" CTS with nail, 350, bucket	1	1	168.00 BK
BAR-CODED BAGS IN A CUT CASE BOX				
551-2CPK2	½" CTS with nail, 10/bag	10	10	1.69 BG
551-3CPK2	¾" CTS with nail, 10/bag	10	10	2.09 BG

PadLock™ Tube Strap

- Isolates tube from surface to reduce heat loss and noise transfer
- Nail or screw locks tube into hanger
- Will not damage tube if over-driven
- Allows tube to expand and contract
- Fits and fastens to our Grid Iron bracket (see p 219)



Fast installations. The PadLock snaps onto tube for "hands free" installation.

Specifications

Nail	Zinc coated ring-shank
Screw	#6 x 1¼" Phillips pan head, self-drilling tip
Hanger Material	U.V. protected high density polyethylene
Impact Resistance	to 0°F (-18°C)
Maximum Temperature	160°F (71°C) continuous



Item No.	Description	Min. Qty.	Case Qty.	List Price
BULK				
551-P2	½" CTS with nail	100	1000	0.16 EA
551-P3	¾" CTS with nail	50	500	0.27 EA
551-P2S	½" CTS with screw	100	1000	0.24 EA
551-P3S	¾" CTS with screw	50	500	0.35 EA
BAR-CODED BAGS IN A CUT CASE BOX				
551-P2PK2	½" CTS with nail, 10/bag	10	10	2.00 BG
551-P3PK2	¾" CTS with nail, 10/bag	10	10	3.00 BG

TouchDown™ Universal Pipe Clamp

Patent # 6,126,122

- Clamps ¼" – 1" CTS tube (copper or plastic) and ½" – 1" Sch. 40 pipe (steel or plastic)
- Releasable locking mechanism
- Perfect when various pipe and tube sizes are used
- Variable clamping tension allows for expansion and contraction of tube
- Provides ¼" stand-off

Pipe Down™ Noise Absorbing Inserts

- Thermoplastic elastomer reduces noise
- Not for use with E84 clamps



550-11



550F11



550-11Q



550-11PK4

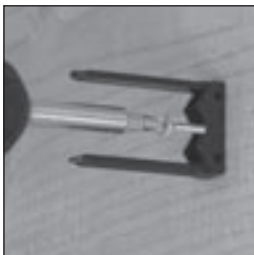

Screw base onto surface with drill or screwdriver.

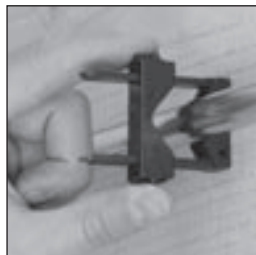

Ratchet bridge down to secure pipe.

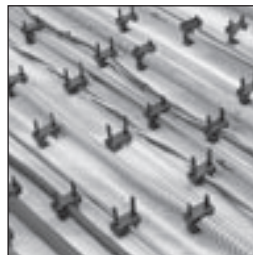

Perfect for many different types of pipe, tube, and wire.

Related Products
Grid Iron p 219

Item No.	Description	Min. Qty.	Case Qty.	List Price
BLACK NYLON				
BULK				
550-11	1 bridge, 1 base, 1 screw/bag	100	100	0.53 BG
550-11Q	1 bridge, 1 base, 1 screw, 1 set of Pipe Down inserts/bag	100	100	1.16 BG
550-12	100 bridges, 100 bases, 100 screws/bag	1	1	36.00 BG
BAR-CODED BAGS IN A CUT CASE BOX				
550-11PK2	5 bridges, 5 bases, 5 screws/bag	10	10	3.30 BG
550-11QPK2	10 bridges, 10 bases, 10 screws, 10 sets of Pipe Down inserts/bag	1	10	11.75 BG
BAR-CODED BAGS IN A BAR-CODED DISPENSER BOX				
550-11PK4	5 bridges, 5 bases, 5 screws/bag, 10 bags/box	1	1	30.00 BX
FIRE FIGHTER E84 PLENUM-SAFE				
550F11	1 bridge, 1 base, 1 screw/bag	25	25	3.00 BG
PIPE DOWN INSERTS				
BULK				
522-100B	100 inserts for bridge or base for black nylon only/bag	1	100	31.00 BG
BAR-CODED BAGS IN A CUT CASE BOX				
522-100BPK2	10 inserts for bridge or base for black nylon only/bag	1	10	3.75 BG

Specifications

Clamp Range	.375" – 1.315"	
Screw	#6 x 1" zinc plated, bugle head, drill point	
Nylon Hanger	100% corrosion proof virgin nylon 66 U.V. protected, UL94 V-2 rated	
E84 Plenum-Safe	Polyvinylidene Fluoride (PVDF) Meets ASTM E84 25/50 & UL94 V-0	
Pipe Down Inserts	Thermoplastic elastomer Insert does not change clamp range Not for use with Fire Fighter E84 clamps	
Safe Working Load		
Temp(°F)	Black Nylon	E84 Plenum-Safe
-10	70 lbs.	50 lbs.
10		
30		
50		
70		
90	35 lbs.	25 lbs.
110		
130		
150	38 lbs.	25 lbs.
170		
190		
210	12 lbs.	25 lbs.
230		
NOT RECOMMENDED for ANY load		



Pipe Down Noise Inserts do not alter heat/weight tolerances. Testing load applied to bridge.

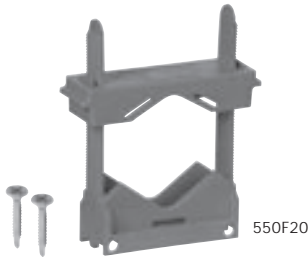

TouchDown II™ Large Universal Pipe Clamp

Patent # 6,126,122

- Clamps ½" – 2" CTS tube (copper or plastic) and ¾" – 2" Sch. 40 pipe (steel or plastic)
- Releasable locking mechanism
- Variable clamping tension allows for expansion and contraction
- Use with AC condenser line sets
- Provides 5/8" stand-off

Pipe Down™ Noise Absorbing Inserts

- Thermoplastic elastomer reduces noise from banging pipes
- Not for use with E84 clamps



Slot in base allows for stainless steel band applications.



Fits into the Universal Slider Bracket and Power Bar.



Perfect for large or irregular pipe sizes like AC condenser line sets.

Specifications

Clamp Range	5/8" – 2 3/4" 5/8" – 2 3/4" with inserts	
Screw	#6 x 1" zinc plated, bugle head, drill point	
Nylon Hanger	100% corrosion proof virgin nylon 66 U.V. protected, UL94 V-2 rated	
E84 Plenum-Safe	Polyvinylidene Fluoride (PVDF) Meets ASTM E84 25/50 & UL94 V-O	
Pipe Down Inserts	Thermoplastic elastomer Not for use with Fire Fighter E84 clamps	
Safe Working Load		
Temp (°F)	Black Nylon	E84 Plenum-Safe
-10	150 lbs.	50 lbs.
10		
30		
50		
70		
90	35 lbs.	25 lbs.
110		
130		
150	105 lbs.	25 lbs.
170		
190	70 lbs.	25 lbs.
210		
230		
NOT RECOMMENDED for ANY load		

Pipe Down Noise Inserts do not alter heat/weight tolerances. Testing load applied to bridge.

Related Products

Grid Iron p 219

Item No.	Description	Min. Qty.	Case Qty.	List Price
BLACK NYLON BULK				
550-20	1 bridge, 1 base, 2 screws/bag	50	50	1.28 BG
550-20Q	1 bridge, 1 base, 2 screws, 2 Pipe Down inserts/bag	50	50	1.58 BG
550-22	50 bridges, 50 bases, 100 screws/bar	1	1	54.00 BG
BAR-CODED BAGS IN A CUT CASE BOX				
550-20PK2	1 bridge, 1 base, 2 screws/bag	10	10	1.81 BG
550-20QPK2	6 bridges, 6 bases, 12 screws, 12 Pipe Down inserts/bag	1	10	9.80 BG
BAR-CODED BAGS IN A BAR-CODED DISPENSER BOX				
550-20PK4	1 bridge, 1 base, 2 screws/bag, 15 bags/box	1	1	31.99 BX
FIRE FIGHTER E84 PLENUM-SAFE				
550F20	1 bridge, 1 base, 2 screws/bag	25	25	7.95 BG
PIPE DOWN INSERTS BULK				
550-200B	50 inserts for black nylon only/bag	1	10	26.00 BG
BAR-CODED BAGS IN A CUT CASE BOX				
550-200BPK2	10 inserts for black nylon only/bag	1	10	5.50 BG



TouchDown™ Beam Clamp
TouchDown II™ Beam Clamp
Universal Pipe Clamp

- Easily attaches to I-beams or steel truss members for parallel or perpendicular pipe runs

TouchDown II™ Strut Clamp
Large Universal Pipe Clamp for Strut

- No tools required for fast and easy installation
- One clamp fits ½" CTS–2" IPS

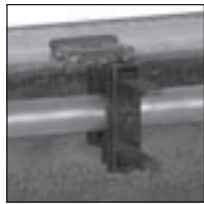

Run pipes parallel to steel I-beams.



Strut clamp twists and locks into strut channel.

Item No.	Description	Min. Qty.	Case Qty.	List Price
TOUCHDOWN BEAM CLAMP				
NEW 550-11E	1 bridge, 1 base with attached beam clamp/bag	100	100	1.98 BG
TOUCHDOWN II BEAM CLAMP				
NEW 550-20E	1 bridge, 1 base, 1 screw, beam clamp/bag	25	25	2.80 BG
TOUCHDOWN II STRUT CLAMP				
550-2T	1 bridge, 1 base with strut clamp/bag	25	25	1.85 BG
NEW 550-2T1	2 bridges, 1 base with strut clamp/bag	25	25	2.20 BG
550-22T	50 bridges, 50 bases with strut clamp/bag	1	1	87.00 BG
FIRE FIGHTER E84 PLENUM-SAFE TOUCHDOWN II STRUT CLAMP				
550F2T	E84: 1 bridge, 1 base with strut clamp/bag	5	5	8.45 BG



Specifications

Item	Maximum Beam Range	Safe working loads and hanger specifications are the same as other TouchDown and TouchDown II models. See Specification tables on previous two pages.
550-11E	¼"	
550-20E	½"	

Suspension Clamp

- Ribs allows pipe to glide easier and more silently when the pipe expands and contracts
- Split design allows for use after piping run
- Improved stronger design

Related Products
Suspensulator p 191
Dual purpose Suspensulators reduce SKUs.

Item No.	Description	Min. Qty.	Case Qty.	List Price
STANDARD				
BULK				
557-2	½" CTS	100	1000	0.22 EA
557-3	¾" CTS	100	1000	0.23 EA
557-4	1" CTS	50	500	0.52 EA
557-5	1¼" CTS	25	250	0.96 EA
557-6	1½" CTS	25	250	1.08 EA
557-7	2" CTS	25	250	1.40 EA
BAR-CODED BAGS IN CUT CASE BOX				
557-2PK2	½" CTS, 5/bag	10	10	1.50 BG
557-3PK2	¾" CTS, 5/bag	10	10	1.58 BG
FIRE FIGHTER E84 PLENUM-SAFE				
557F2	½" CTS, E84	100	1000	1.25 EA
557F3	¾" CTS, E84	100	1000	1.50 EA
557F4	1" CTS, E84	50	500	2.05 EA



557-2



557F3

Specifications

	Standard	E84
Material	Super high impact polypropylene	Polyvinylidene Fluoride (PVDF)
Rating	—	ASTM E84 25/50 UL94 V-0
Safe Working Load	15 lbs.	
Impact Resistance	to 0°F (-18°C)	
Maximum Temperature	140°F (60°C) continuous	

Not for use on copper heat recirculating lines.



Specifications

Material	Low density polyethylene
Impact Resistance	to 0°F (-18°C)
Maximum Temperature	180°F (82°C) continuous

Not for use on copper heat recirculating lines.

Tube Insulator

- Ribs allows pipe to glide easier and more silently when the pipe expands and contracts
- Split design allows for use after piping run
- Fits in either 1 1/32" or 1 3/8" hole in metal or wood stud

Related Products
 Suspensulator p 191
 Compatible brackets p 215-216

Item No.	Description	Min. Qty.	Case Qty.	List Price
BULK				
558-2	1/2" CTS	50	500	0.36 EA
558-3	3/4" CTS	50	500	0.37 EA
558-4	1" CTS	25	250	0.38 EA
BAR-CODED BAGS IN A CUT CASE BOX				
558-2PK2	1/2" CTS, 5/bag	10	10	1.92 BG
558-3PK2	3/4" CTS, 5/bag	10	10	1.97 BG



559-2



559F2

Specifications

	Standard	E84
Material	Super high impact polypropylene	Polyvinylidene Fluoride (PVDF)
Rating	-	ASTM E84 25/50 UL94 V-0
Safe Working Load	15 lbs.	
Impact Resistance	to 0°F (-18°C)	
Maximum Temperature	140°F (60°C) continuous	

Not for use on copper heat recirculating lines.

Tube Clamp

- Ribs allows pipe to glide easier and more silently when the pipe expands and contracts
- Split design allows for use after piping run
- V-shaped notch makes it easier to snap onto tube

Item No.	Description	Min. Qty.	Case Qty.	List Price
STANDARD				
BULK				
559-2	1/2" CTS	100	1000	0.22 EA
559-3	3/4" CTS	50	1000	0.23 EA
559-4	1" CTS	50	500	0.52 EA
559-5	1 1/4" CTS	25	250	0.68 EA
559-6	1 1/2" CTS	25	250	1.07 EA
559-7	2" CTS	25	250	1.18 EA
BAR-CODED BAGS IN A CUT CASE BOX				
559-2PK2	1/2" CTS, 5/bag	10	10	1.28 BG
559-3PK2	3/4" CTS, 5/bag	10	10	1.32 BG
FIRE FIGHTER E84 PLENUM-SAFE				
559F2	1/2" CTS	100	1000	1.25 EA
559F3	3/4" CTS	50	1000	1.50 EA
559F4	1" CTS	50	500	2.05 EA

Vinyl-Coated Steel Clamp with Screw

- Do not use with CPVC pipe or fittings
- Perfect for hydronic heating



Specifications

Screw #8 x 1" zinc coated Phillips pan-head, drill till



Item No.	Description	Min. Qty.	Case Qty.	List Price
523-31	5/16" clamp for 3/8" nom. tube, re-bar or thread rod	100	100	0.57 EA
523-32	5/8" clamp for 1/2" nom. tube	100	100	0.57 EA
523-33	7/8" clamp for 3/4" nom. tube	50	50	0.79 EA
523-34	1 1/8" clamp for 1" nom. tube	50	50	0.98 EA

SUPPLY

DRAINAGE

SUPPORT

TESTING

SPECIALTIES

TOOLS

ACCESS

2-Hole Tube Strap

Copper & Copper Plated Steel CTS
Galvanized Steel IPS

Related Products
Tube Clamp

p 198

Item No.	Description	Nails	Gauge	Min. Qty.	Case Qty.	List Price
COPPER						
500-2	½" CTS	zinc coated	24	100	500	0.30 EA
500-3	¾" CTS	zinc coated	24	100	500	0.35 EA
COPPER PLATED						
BULK						
501-0	¼" CTS	zinc coated	24	100	500	0.10 EA
501-1	⅜" CTS	zinc coated	24	100	500	0.11 EA
501-2	½" CTS	zinc coated	24	100	500	0.105 EA
501-3	¾" CTS	zinc coated	24	100	500	0.13 EA
501-4	1" CTS	zinc coated	22	100	100	0.20 EA
501-5	1¼" CTS	ring-shank	22	100	100	0.30 EA
501-6	1½" CTS	ring-shank	22	100	100	0.32 EA
501-7	2" CTS	ring-shank	22	100	100	0.35 EA
INDIVIDUALLY BARCODED IN A CUT-CASE BOX						
501-0PK	¼" CTS	—	24	100	100	0.21 EA
501-1PK	⅜" CTS	—	24	100	100	0.23 EA
501-2PK	½" CTS	—	24	100	100	0.24 EA
501-3PK	¾" CTS	—	24	100	100	0.27 EA
501-4PK	1" CTS	—	22	100	100	0.34 EA
501-5PK	1¼" CTS	—	22	100	100	0.44 EA
501-6PK	1½" CTS	—	22	100	100	0.46 EA
501-7PK	2" CTS	—	22	100	100	0.49 EA
BAR-CODED BAGS IN A CUT CASE BOX						
501-2PK2	½" CTS, 10/bag	zinc coated	24	10	10	2.17 BG
501-3PK2	¾" CTS, 10/bag	zinc coated	24	10	10	2.49 BG
GALVANIZED STEEL						
BULK						
502-0	¼" IPS	—	22	100	100	0.13 EA
502-1	⅜" IPS	—	22	100	100	0.14 EA
502-2	½" IPS	—	22	100	100	0.15 EA
502-3	¾" IPS	—	22	100	100	0.18 EA
502-4	1" IPS	—	20	100	100	0.28 EA
502-5	1¼" IPS	—	20	50	50	0.41 EA
502-6	1½" IPS	—	20	50	50	0.45 EA
502-7	2" IPS	—	18	50	50	0.59 EA
502-75	2½" IPS	—	16	25	25	1.21 EA
502-8	3" IPS	—	16	25	25	1.45 EA
502-9	4" IPS	—	16	25	25	1.73 EA
INDIVIDUALLY BAR-CODED IN A CUT CASE BOX						
502-0PK	¼" IPS	—	22	100	100	0.24 EA
502-1PK	⅜" IPS	—	22	100	100	0.25 EA
502-2PK	½" IPS	—	22	100	100	0.26 EA
502-3PK	¾" IPS	—	22	100	100	0.29 EA
502-4PK	1" IPS	—	20	100	100	0.39 EA
502-5PK	1¼" IPS	—	20	50	50	0.52 EA
502-6PK	1½" IPS	—	20	50	50	0.56 EA
502-7PK	2" IPS	—	18	50	50	0.70 EA
502-75PK	2½" IPS	—	16	20	20	1.32 EA
502-8PK	3" IPS	—	16	15	15	1.56 EA
502-9PK	4" IPS	—	16	10	10	1.84 EA
BAR-CODED BAGS IN A CUT CASE BOX						
502-2PK2	½" IPS, 10/bag	—	22	10	10	1.82 BG
502-3PK2	¾" IPS, 10/bag	—	22	10	10	2.12 BG
502-4PK2	1" IPS, 4/bag	—	20	10	10	1.31 BG
502-5PK2	1¼" IPS, 4/bag	—	20	10	10	1.83 BG

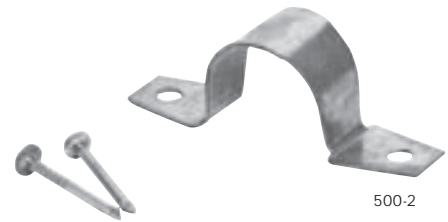

500-2

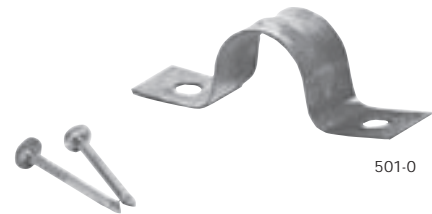

501-0



502-2

SUPPLY

DRAINAGE

SUPPORT

TESTING

SPECIALTIES

TOOLS

ACCESS



503-2



503-2P



504-3



504-3P

Drive Hook

Copper Plated Steel

- Do not use vinyl-coated hooks with CPVC pipe or fittings

Related Products

Pick-Up Talon
Twin Talon

p 193
p 192

Item No.	Description	Vinyl Coated	Min. Qty.	Case Qty.	List Price
J-HOOK					
BULK					
503-2	1/2" CTS		100	1000	0.13 EA
503-3	3/4" CTS		100	1000	0.15 EA
503-2P	1/2" CTS	✓	100	1000	0.25 EA
503-3P	3/4" CTS	✓	100	1000	0.28 EA
BAR-CODED BAGS IN A CUT CASE BOX					
503-3PK2	3/4" CTS, 10/bag		10	10	1.85 EA
TUBE NAILER					
BULK					
504-3	1/2"-3/4" CTS		100	1000	0.15 EA
504-3P	1/2"-3/4" CTS	✓	100	1000	0.30 EA
BAR-CODED BAGS IN A CUT CASE BOX					
504-3PK2	1/2"-3/4" CTS, 10/bag		10	10	1.82 BG
504-3PK3	1/2"-3/4" CTS, 100/bag		1	10	15.08 BG
504-3PPK2	1/2"-3/4" CTS, 10/bag	✓	10	10	3.32 BG

Wire Pipe Hook

Steel

10-Gauge Copper Plated Steel

Related Products

Hangs Tuff Jr.

p 205



Item No.	Description	Min. Qty.	Case Qty.	List Price
PLAIN STEEL				
BULK				
506-24	1/2" IPS x 4"	50	500	0.20 EA
506-26	1/2" IPS x 6"	50	500	0.21 EA
506-34	3/4" IPS x 4"	50	500	0.23 EA
506-36	3/4" IPS x 6"	50	500	0.23 EA
506-38	3/4" IPS x 8"	50	500	0.29 EA
506-46	1" IPS x 6"	50	500	0.23 EA
506-56	1 1/4" IPS x 6"	50	500	0.35 EA
506-66	1 1/2" IPS x 6"	50	500	0.39 EA
506-78	2" IPS x 8"	50	50	0.46 EA
506-710	2" IPS x 10"	50	50	0.48 EA
BAR-CODED BUNDLES IN A CUT CASE BOX				
506-26PK2	1/2" IPS x 6", 5/bundle	5	5	1.39 BD
506-36PK2	3/4" IPS x 6", 5/bundle	5	5	1.49 BD
506-46PK2	1" IPS x 6", 5/bundle	5	5	1.49 BD
COPPER PLATED STEEL				
BULK				
506-22C	1/2" IPS x 2 1/2"	100	2000	0.11 EA
506-24C	1/2" IPS x 4"	50	500	0.23 EA
506-26C	1/2" IPS x 6"	50	500	0.25 EA
506-32C	3/4" IPS x 2 1/2"	100	2000	0.12 EA
506-34C	3/4" IPS x 4"	50	500	0.26 EA
506-36C	3/4" IPS x 6"	50	500	0.28 EA
506-38C	3/4" IPS x 8"	50	500	0.33 EA
506-46C	1" IPS x 6"	50	500	0.30 EA
BAR-CODED BUNDLES IN A CUT CASE BOX				
506-26CPK2	1/2" IPS x 6", 5/bundle	5	5	1.59 BD
506-36CPK2	3/4" IPS x 6", 5/bundle	5	5	1.74 BD
506-46CPK2	1" IPS x 6", 5/bundle	5	5	1.84 BD

Wire Pipe Hook

Vinyl-Coated Steel

Vinyl-Coated 10-Gauge Copper Plated Steel

- Do not use vinyl-coated wire pipe hooks with CPVC pipe or fittings



506-24P



506-36PPK2

Related Products
Hangs Tuff Jr. p 205

Item No.	Description	Min. Qty.	Case Qty.	List Price
VINYL-COATED STEEL				
BULK				
506-24P	1/2" IPS x 4"	50	500	0.40 EA
506-26P	1/2" IPS x 6"	50	500	0.42 EA
506-34P	3/4" IPS x 4"	50	500	0.38 EA
506-36P	3/4" IPS x 6"	50	500	0.40 EA
506-38P	3/4" IPS x 8"	50	500	0.46 EA
506-46P	1" IPS x 6"	50	500	0.48 EA
506-56P	1 1/4" IPS x 6"	50	500	0.54 EA
506-66P	1 1/2" IPS x 6"	50	500	0.56 EA
506-78P	2" IPS x 8"	50	50	0.66 EA
BAR-CODED BUNDLES IN A CUT CASE BOX				
506-26PPK2	1/2" IPS x 6", 5/bundle	5	5	2.44 BD
506-36PPK2	3/4" IPS x 6", 5/bundle	5	5	2.34 BD
506-46PPK2	1" IPS x 6", 5/bundle	5	5	2.74 BD
VINYL-COATED COPPER PLATED STEEL				
506-24CP	1/2" IPS x 4"	50	1000	0.38 EA
506-26CP	1/2" IPS x 6"	50	1000	0.44 EA
506-34CP	3/4" IPS x 4"	50	1000	0.39 EA
506-36CP	3/4" IPS x 6"	50	1000	0.42 EA
506-38CP	3/4" IPS x 8"	50	1000	0.50 EA
506-46CP	1" IPS x 6"	50	1000	0.52 EA

CTS Bell Hanger

Copper Plated Steel

- 13/16" standoff
- Includes two clamp screws and one 2 1/2" mounting screw
- Mounting screw is recessed and does not contact the tube



Related Products
TouchDown p 195

Item No.	Description	Min. Qty.	Case Qty.	List Price
INDIVIDUALLY BAR-CODED IN A CUT CASE BOX				
508-2PK	1/2" CTS	25	25	1.60 EA
508-3PK	3/4" CTS	25	25	1.65 EA
508-4PK	1" CTS	25	25	1.70 EA

Supply Hangers

CATALOG 2007



554-608

554-08

Cable Tie

- Durable, non-corrosive black nylon
- Use a #10 screw or nail to secure mounting cable ties

Item No.	Length x Width	Failure Load	Max. Bundle	Min. Qty.	Case Qty.	List Price
STANDARD						
554-08	8" x 3/16"	50 lbs.	2"	100	2500	0.071 EA
554-14	14 1/2" x 3/16"	40 lbs.	4"	100	1000	0.14 EA
554-21	21" x 5/16"	175 lbs.	6"	50	500	0.47 EA
554-36	36" x 5/16"	175 lbs.	11"	50	250	0.64 EA
MOUNTING						
554-608	8" x 3/16"	50 lbs.	2 3/8"	100	500	0.18 EA
554-614	14" x 3/16"	50 lbs.	4"	100	1000	0.28 EA

Anchor Screw Kit

- Each kit includes:
100 1" zinc plated screws, 100 flanged plastic anchors, carbide masonry drill bit, reusable polypro box



Item No.	Description	Min. Qty.	Case Qty.	List Price
590-08	Kit: 100 #8 x 1" 1/4" hex/slotted/Phillips head screws, 100 plastic anchors, and one 1/4" carbide bit	1	10	8.00 KT
590-10	Kit: 100 #10 x 1" 5/16" hex/slotted/Phillips head screws, 100 plastic anchors, and one 1/4" carbide bit	1	10	7.69 KT
591-08	#8 x 1" zinc plated 1/4" hex/Phillips screw, 100/bag	1	10	4.00 BG
591-081	#8 x 1" zinc plated drill-tip Phillips screw, 100/bag	1	10	4.80 BG
591-10	#10 x 1" zinc plated 5/16" hex/slotted/Phillips screw, 100/bag	1	10	4.30 BG
591-63SSB	#6 x 3/4" stainless steel hex screw, drill tip, 100/bag	1	10	17.00 BG
592-10	Plastic anchor for #8, #10 & #12 screws, 100/bag	1	10	3.30 BG
593-10	1/4" plated, carbide tipped masonry bit	1	50	1.50 EA

Tube Strap Nail



Specifications

1 1/8" x 13 gauge, 1 3/4" head zinc coated nails

Item No.	Description	Min. Qty.	Case Qty.	List Price
509	Tube strap nail, 1,000/box	1	10	16.11 BX
509-PK2	Tube strap nail, 50/bag	20	20	1.85 BG

Clevis Hanger

- Stamped metal
- For use with all thread rod up to 3/8"
- For suspension of light loads, pipe or conduit



Item No.	Description	Min. Qty.	Case Qty.	List Price
GALVANIZED				
BAR-CODED BAGS IN A CUT CASE BOX				
515-2GPK2	1/2" IPS, 1/bag	10	10	1.63 BG
515-3GPK2	3/4" IPS, 1/bag	10	10	1.69 BG
515-4GPK2	1" IPS, 1/bag	10	10	1.70 BG
515-5GPK2	1 1/4" IPS, 1/bag	10	10	1.94 BG
515-6GPK2	1 1/2" IPS, 1/bag	10	10	2.23 BG
515-7GPK2	2" IPS, 1/bag	10	10	2.34 BG
515-8GPK2	2 1/2" IPS, 1/bag	10	10	3.75 BG
515-9GPK2	3" IPS, 1/bag	10	10	4.23 BG
515-10GPK2	4" IPS, 1/bag	10	10	4.54 BG
COPPERCLAD				
BAR-CODED BAGS IN A CUT CASE BOX				
515-2CPK2	1/2" CTS, 1/bag	10	10	1.78 BG
515-3CPK2	3/4" CTS, 1/bag	10	10	1.81 BG
515-4CPK2	1" CTS, 1/bag	10	10	1.90 BG
515-5CPK2	1 1/4" CTS, 1/bag	10	10	2.00 BG
515-6CPK2	1 1/2" CTS, 1/bag	10	10	2.10 BG
515-7CPK2	2" CTS, 1/bag	10	10	2.38 BG

Specifications

Pipe Size	Maximum Recommended Load
1/2"	150 lbs.
3/4" - 2"	250 lbs.
2 1/2" - 4"	500 lbs.

Split Ring Hanger

- Malleable Iron
- For use with 3/8" all thread rod
- For suspension of non-insulated stationary pipe



Item No.	Description	Min. Qty.	Case Qty.	List Price
GALVANIZED				
BAR-CODED BAGS IN A CUT CASE BOX				
516-2GPK2	1/2" IPS, 1/bag	20	20	1.25 BG
516-3GPK2	3/4" IPS, 1/bag	20	20	1.44 BG
516-4GPK2	1" IPS, 1/bag	10	10	1.50 BG
516-5GPK2	1 1/4" IPS, 1/bag	10	10	1.88 BG
516-6GPK2	1 1/2" IPS, 1/bag	10	10	2.10 BG
516-7GPK2	2" IPS, 1/bag	10	10	2.10 BG
COPPERCLAD				
BAR-CODED BAGS IN A CUT CASE BOX				
516-2CPK2	1/2" CTS, 1/bag	20	20	1.40 BG
516-3CPK2	3/4" CTS, 1/bag	20	20	1.50 BG
516-4CPK2	1" CTS, 1/bag	10	10	1.75 BG
516-5CPK2	1 1/4" CTS, 1/bag	10	10	1.90 BG
516-6CPK2	1 1/2" CTS, 1/bag	10	10	2.23 BG

Specifications

Maximum Recommended Load	180 lbs.
--------------------------	----------



Specifications

Maximum Recommended Load	610 lbs. at 650°F
--------------------------	-------------------

3/8" All Thread Rod

- Plain steel

Item No.	Description	Min. Qty.	Case Qty.	List Price
INDIVIDUALLY BAR-CODED IN A TUBE				
544	3/8" x 6 ft	20	20	4.08 EA



Beam Clamp

Top Beam Clamp

- Malleable Iron
- Attaches to bottom of beam
- Use all thread rod to connect split ring hangers, clevis hangers, etc.

C Clamp

- Attaches to bottom of beam not exceeding 3/4"
- Use all thread rod to connect split ring hangers, clevis hangers, etc.
- Includes lock nut

Specifications

	Top Beam Clamp	C Clamp
Maximum Recommended Load	350 lbs.	400 lbs.
Maximum Pipe Size	4"	-

Item No.	Description	Min. Qty.	Case Qty.	List Price
TOP BEAM CLAMP				
BAR-CODED BAGS IN A CUT CASE BOX				
542-PK2	for 3/8" all thread rod, 1/bag	10	10	1.66 BG
C CLAMP				
543	for 3/8" all thread rod	10	10	1.70 EA



Specifications

Maximum Recommended Load	180 lbs.
--------------------------	----------

Top Plate Connector

- Malleable Iron

Item No.	Description	Min. Qty.	Case Qty.	List Price
BAR-CODED BAGS IN A CUT CASE BOX				
541-GPK2	for 3/8" all thread rod – galvanized, 1/bag	20	20	1.20 BG
541-CPK2	for 3/8" all thread rod – copperclad, 1/bag	20	20	1.53 BG



Specifications

Maximum Recommended Load	250 lbs.
--------------------------	----------

Side Beam Connector

- Malleable Iron

Item No.	Description	Min. Qty.	Case Qty.	List Price
540	for 3/8" all thread rod	20	20	0.91 EA

Milford Hanger

Copper Plated

Item No.	Description	Min. Qty.	Case Qty.	List Price
INDIVIDUALLY BAR-CODED IN A CUT CASE BOX				
512-26PK	1/2" CTS x 6"	50	50	1.10 EA
512-36PK	3/4" CTS x 6"	50	50	1.15 EA
512-46PK	1" CTS x 6"	50	50	1.22 EA
512-212PK	1/2" CTS x 12"	50	50	1.63 EA
512-312PK	3/4" CTS x 12"	50	50	1.63 EA
512-412PK	1" CTS x 12"	50	50	2.03 EA



Natick Hanger

Copper Plated

Item No.	Description	Min. Qty.	Case Qty.	List Price
INDIVIDUALLY BAR-CODED IN A CUT CASE BOX				
513-26PK	1/2" CTS x 6"	25	25	1.60 EA
513-36PK	3/4" CTS x 6"	25	25	1.75 EA



Hangs Tuff Jr.™ CTS Tube Hanger

Patent # 5,385,320
Canadian Patent # 2,125,249

- Hangs any 1/2"–1 1/4" CTS tubing
- 100% corrosion proof, impact resistant ABS
- Two ring-shank nails conveniently supplied
- Each hanger is individually bar-coded



Snap off sections of the Hangs Tuff Jr. to create a shorter hanger for tight spaces.



Twin models available to hang two lengths of tube side-by-side more quickly and easily.



Item No.	Description	Min. Qty.	Case Qty.	List Price
INDIVIDUALLY BAR-CODED BULK				
553-22W	1/2" x 1/2" CTS	50	150	1.00 EA
553-23W	1/2" x 3/4" CTS	50	150	1.12 EA
553-33W	3/4" x 3/4" CTS	50	150	1.12 EA
553-2W	1/2" CTS	50	50	0.67 EA
553-3W	3/4" CTS	50	50	0.75 EA
553-4W	1" CTS	50	50	0.82 EA
553-5W	1 1/4" CTS	50	50	0.93 EA



Specifications

Hanger	ABS—U.V. resistant, corrosion proof, impact resistant			
Nail	1 5/8" rust resistant, zinc coated ring-shank			
Maximum Safe Temperature	140°F			
Impact Resistance	to 0°F (–18°C)			
Safe Working Load	Cradle			
	1/2"	3/4"	1"	1 1/4"
	55 lbs.	45 lbs.	35 lbs.	30 lbs.
Safe Working Load	Inverted			
	1/2"	3/4"	1"	1 1/4"
	12 lbs.	12 lbs.	12 lbs.	12 lbs.

DWV Hangers

SUPPLY

DRAINAGE

SUPPORT

TESTING

SPECIALTIES

TOOLS

ACCESS



Hangs Tuff™ DWV Pipe Hanger

Patent # 5,385,320
Canadian Patent # 2,125,249

- Strong and rigid I-beam design keeps pipe secure
- Two ring-shank nails conveniently supplied
- 100% corrosion proof, impact resistant ABS
- Can be glued to ABS or PVC pipe with all-purpose glue



Two nails supplied for easy installation



Opposing holes are 1/2" on center



Cradles pipe before final installation



Locking finger holds pipe in place



Locking finger allows installation at all angles

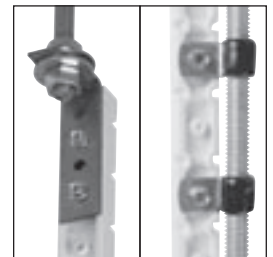

Extend length by using all thread rod and vinyl coated clamps or an L-bracket

According to all national codes, ABS or PVC DWV pipe is to be supported every four feet or less. When hanging steel or cast iron pipe, install Hangs Tuff two feet on center (or less), cinch with cable-tie, and anchor with min. 1 1/2", No. 10 wood screws.

Specifications

Hanger	ABS – U.V. resistant, corrosion proof, impact resistant				
Nail	1 5/8" rust resistant, zinc coated, yellow irradiate, continuous ring-shank				
Maximum Safe Temperature	140°F				
Safe Working Load	Cradle	1 1/2"	2"	3"	4"
	Inverted	15 lbs.	15 lbs.	15 lbs.	15 lbs.
Sch. 40 Pipe Weight	4' PVC full of water	1 1/2"	2"	3"	4"
		5.6 lbs.	8.5 lbs.	18.4 lbs.	31.4 lbs.

Related Products

Vinyl Coated Clamp p 124

Item No.	Description	Dimension		Min. Qty.	Case Qty.	List Price
		A	B			
WHITE						
INDIVIDUALLY BAR-CODED BULK						
553-6W	1 1/2" Sch. 40	8 5/8"	10"	50	50	0.82 EA
553-7W	2" Sch. 40	8 15/16"	10 1/2"	50	50	0.87 EA
553-8W	3" Sch. 40	9 7/16"	11 3/4"	50	50	0.98 EA
553-830W	3" Sch. 30	9 5/16"	11 3/4"	50	50	1.10 EA
553-9W	4" Sch. 40	9 15/16"	12 3/8"	25	25	1.10 EA
BLACK						
INDIVIDUALLY BAR-CODED BULK						
553-6	1 1/2" Sch. 40	8 5/8"	10"	50	50	0.90 EA
553-7	2" Sch. 40	8 15/16"	10 1/2"	50	50	0.96 EA
553-8	3" Sch. 40	9 7/16"	11 3/4"	50	50	1.07 EA
553-9	4" Sch. 40	9 15/16"	12 3/8"	25	25	1.16 EA
L-BRACKET						
521-210	L-bracket for 3/8" all thread rod			25	100	0.98 EA

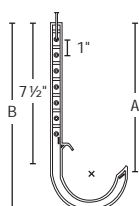

ZipStick™ Universal Pipe Hanger

- Perfect for hanging wrapped or insulated pipe, bundles of PEX, cable, wiring or supporting vent pipe in attics
- Universal cradle hangs any pipe from 1" CTS to 6" IPS
- White or black, with 10", 14" or 26" stems
- Releasable locking mechanism
- Graduated numerals at nail ways for easy measuring

ZipStrap™ Nylon Ratchet-Locking Strap

- Can be added to ZipStick for large O.D. applications

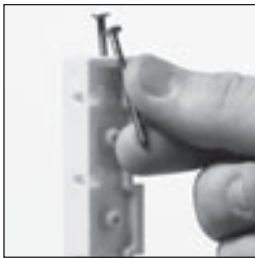

Two nails supplied for easy installation



Opposing holes are 1/2" on center



Easy, more natural, pull-down cinching motion

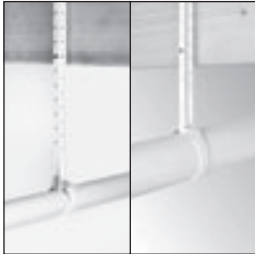

Hangs any pipe 1 1/8" O.D. to 6 3/8" O.D. over center

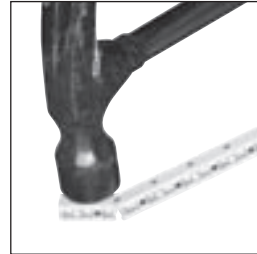

Snap off sections to create a shorter hanger for tight spaces

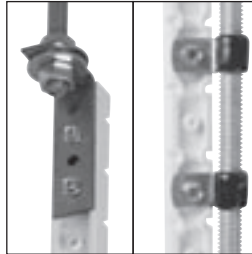

Extend length by using all thread rod and vinyl coated clamps or an L-bracket

Related Products
Vinyl Coated Clamp p 124

Item No.	Description	Dimensions	Min. Qty.	Case Qty.	List Price
		A			
ZIPSTICK					
BULK					
553-010W	white	10"	25	100	2.21 EA
553-014W	white	14"	25	100	2.68 EA
553-026W	white	26"	25	50	4.17 EA
553-010B	black	10"	25	100	2.21 EA
553-014B	black	14"	25	100	2.68 EA
553-026B	black	26"	25	50	4.17 EA
INDIVIDUALLY BAR-CODED IN A CUT CASE BOX					
553-014WPK	white	14"	25	25	2.73 EA
553-014BPK	black	14"	25	25	2.73 EA
ZIPSTRAP					
553-0LW	white	—	1	100	1.29 EA
553-0LB	black	—	1	100	1.29 EA
L-BRACKET					
521-210	L-bracket for 3/8" all thread rod		25	100	0.98 EA



According to all national codes, ABS or PVC DWV pipe is to be supported every four feet or less. When hanging steel or cast iron pipe, install ZipStick two feet on-center (or less), and anchor with 1 1/2", No. 10 wood screws.

Specifications

Hanger	ABS shank, polypro strap – 100% corrosion proof, U.V. protected, UL94 V2 flame rating		
Nail	1 1/2" rust resistant, zinc coated, continuous ring-shank		
Maximum Safe Temperature	140°F		
Safe Working Load	32°F	72°F	140°F
	50 lbs.	50 lbs.	25 lbs.

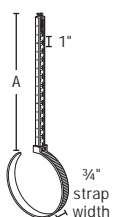

SUPPLY

DRAINAGE

SUPPORT

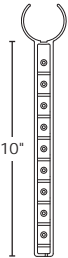

Specifications

Maximum Safe Temperature	140°F
Maximum Load Rating	25 lbs.

Stick-Em Up™
DWV Pipe Support

- 100% corrosion proof, impact resistant, white ABS
- Strong I-beam design
- Can be glued to ABS or PVC pipe with all-purpose glue
- Each model supports two pipe sizes



Glue to DWV pipe to support vertical runs



Secure pipe to form for stack placement inside stud wall



Numbered nail ways are 1" on center for easy measuring and drain calculation

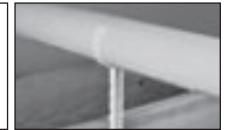

Support horizontal runs of vent pipe in the attic



Item No.	Description	Min. Qty.	Case Qty.	List Price
549-712	1 1/2"-2" DWV	50	100	2.05 EA
549-734	3"-4" DWV	25	100	2.10 EA

TESTING

SPECIALTIES

TOOLS

ACCESS



535-914

535-14



535-9P

Tomahawk™
DWV Ground Stakes

Patent No. 6,901,716 B1 (535-14 and 535-26)

- Prevents pipe from floating or moving during concrete pours
- Use with 1 1/2"-6" Sch. 40 DWV piping
- 14" or 26" lengths available



Secures DWV pipe on grade, preventing stub ups from moving or floating during concrete pour

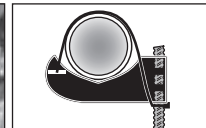

When supporting pipe above ground, secure pipe with cable ties, wire, tape, etc. Use 535-9P poly head inverted on your own 3/8" (#3) re-bar

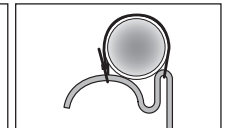

Specifications

Safe Working Load	82.5 lbs. for pipe resting on poly head
Maximum Safe Temperature	140°F



Item No.	Length	Min. Qty.	Case Qty.	List Price
3/8" ALL STEEL				
535-14	14"	25	25	2.35 EA
535-26	26"	25	25	3.43 EA
POLYETHYLENE HEAD				
535-914	14"	25	25	2.31 EA
535-926	26"	25	25	3.26 EA
535-9P	head only	50	50	0.63 EA

DWV Hanger

Galvanized
Vinyl Coated

- Locking screw keeps pipe secure
- Keyhole design provides faster installations

Related Products

ZipStick p 207
A better hanger.

Item No.	Description	Min. Qty.	Case Qty.	List Price
GALVANIZED				
INDIVIDUALLY BAR-CODED IN A CUT CASE BOX				
510-6PK	1 1/2" DWV	20	20	1.77 EA
510-7PK	2" DWV	20	20	1.90 EA
510-8PK	3" DWV	20	20	2.38 EA
510-9PK	4" DWV	20	20	2.66 EA
VINYL COATED				
INDIVIDUALLY BAR-CODED IN A CUT CASE BOX				
510-6VPK	1 1/2" DWV	10	10	3.60 EA
510-7VPK	2" DWV	10	10	3.82 EA
510-8VPK	3" DWV	10	10	4.50 EA
510-9VPK	4" DWV	10	10	5.35 EA



510-9



510-9V

Hanger Strap

Galvanized with 1/4" Holes
Galvanized with Alternating 1/4" and 3/16" Holes
Copper Plated with Alternating 1/4" and 3/16" Holes
Polypropylene with 1/8" Holes

Related Products

Hangs Tuff p 206
A better hanger.

Item No.	Description	Gauge	Min. Qty.	Case Qty.	List Price
GALVANIZED STEEL WITH 1/4" HOLES					
524-10B	3/4" x 10 ft. coil	24	25	25	1.45 EA
528-10B	3/4" x 10 ft. coil	28	25	25	1.47 EA
GALVANIZED STEEL WITH ALTERNATING 1/4" AND 3/16" HOLES					
BULK					
524-10	3/4" x 10 ft. coil	24	50	50	1.40 EA
524-50	3/4" x 50 ft. coil	24	10	10	7.76 EA
524-100	3/4" x 100 ft. coil	24	5	5	14.90 EA
528-10	3/4" x 10 ft. coil	28	50	50	1.37 EA
528-50	3/4" x 50 ft. coil	28	10	10	6.21 EA
528-100	3/4" x 100 ft. coil	28	5	5	12.42 EA
BAR-CODED IN A CUT CASE BOX					
524-10PK2	3/4" x 10 ft. coil, 1/bag	24	10	10	1.56 BG
524-50PK3	3/4" x 50 ft. coil, 1/box	24	1	1	8.00 BX
COPPER PLATED STEEL WITH ALTERNATING 1/4" AND 3/16" HOLES					
BULK					
524-10C	3/4" x 10 ft. coil	24	50	50	3.77 EA
BAR-CODED BAGS IN A CUT CASE BOX					
524-10CPK2	3/4" x 10 ft. coil, 1/bag	24	10	10	3.98 BG
POLYPROPYLENE WITH 1/8" HOLES					
BULK					
554-25	3/4" x 25 ft. coil	—	1	20	2.98 EA
554-100	3/4" x 100 ft. coil	—	1	20	9.90 EA
BAR-CODED BAGS IN A CUT CASE BOX					
554-10PK2	3/4" x 10 ft. coil	—	10	10	1.73 BG



528-10B



528-50

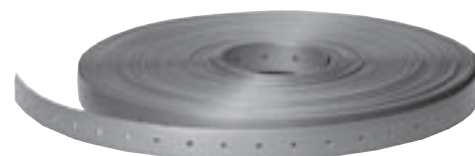

554-100

Specifications

Maximum Recommended Load	24 gauge	28 gauge	Polypro*
	125 lbs. per strand	80 lbs. per strand	20 lbs. per strand

*Polypro hanger strap is not for use in extremely cold conditions.



Universal Slider Bracket™ Adjustable Pipe Bracket & Clamping System

Patent Nos. 6,446,915 and 6,402,096

- Galvanized steel bracket and tough nylon clamp is strong and supports pipe without bowing
- Available with one, two, or three TouchDown clamps pre-loaded to reduce installation time
- Smaller USB expands to fit openings from 11" to 19"
- Larger USB expands to fit openings from 14" to 26"

Be Careful. The USB has sharp steel edges. Wear gloves when handling.

Overlap the Bracket. The bracket should overlap a minimum of 2" in center.

Cinch Evenly. Use pliers to evenly "bow the bridge" for maximum clamp tension.

Fasten Securely. We recommend fastening with screws in all four tabs when installing.

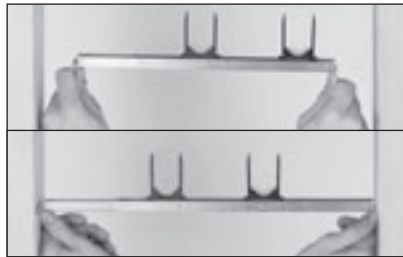

Adjustable bracket slides to fit almost any opening. Installs quickly and easily.

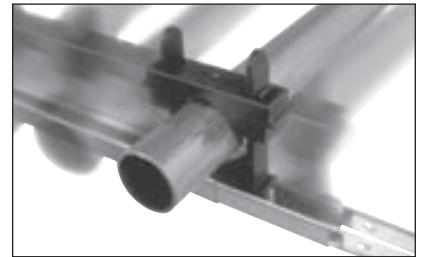

Clamps slide freely to allow any pipe center. Installing the bridge secures the clamp.

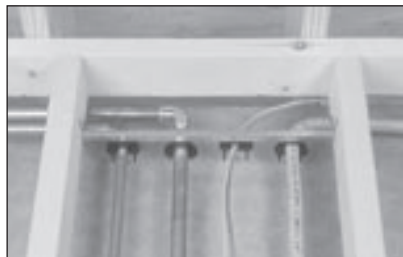

Universal clamps affix copper, CPVC, PEX and steel pipe—or use it for cable, conduit, etc.



Clamps release with a slotted screwdriver. Relieve tension, realign or replace the tube without damage to clamp.



The TouchDown II fits into the tracks of the USB. Use one screw to secure.



Perfect for suspending pipe between any type of joists.

Universal Slider Bracket™ Adjustable Pipe Bracket & Clamping System

Patent Nos. 6,446,915 and 6,402,096

TouchDown™ Universal Pipe Clamp

- Clamps fasten any pipe from ¼" O.D.–1⅛" O.D.
- Clamps preloaded into bracket
- E84 models meet ASTM E84 25/50 and UL94 V-0

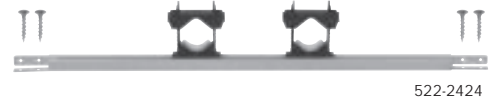

Item No.	Description	Min. Qty.	Case Qty.	List Price
USB FOR 11" – 19" OPENINGS				
BULK				
522-16	1 bracket	50	50	2.46 EA
522-1604	1 bracket, 4 wood screws	50	50	2.81 EA
522-1610	1 bracket, 1 TouchDown clamp	50	50	3.21 EA
522-1620	1 bracket, 2 TouchDown clamps	50	50	3.66 EA
522-1614	1 bracket, 1 TouchDown clamp, 4 wood screws	50	50	3.36 EA
522-161463	1 bracket, 1 TouchDown clamp, 4 drill-tip screws	50	50	3.48 EA
522-1624	1 bracket, 2 TouchDown clamps, 4 wood screws	50	50	3.81 EA
522-16245	1 bracket, 2 TouchDown clamps, 4 zinc plated nails	50	50	3.81 EA
522-162463	1 bracket, 2 TouchDown clamps, 4 drill-tip screws	50	50	3.93 EA
522-1630	1 bracket, 3 TouchDown clamps	50	50	4.41 EA
522-1634	1 bracket, 3 TouchDown clamps, 4 wood screws	50	50	4.56 EA
522-162001	50 brackets, 100 TouchDown clamps, bases loaded in bracket, bridges in a bag	1	1	178.00 BG
522-162401	50 brackets, 100 TouchDown clamps, 200 wood screws; bases loaded, bridges in a bag, screws in a bag	1	1	185.50 BG
BAR-CODED CARDS IN A CUT CASE BOX				
522-1620PK1	1 bracket, 2 TouchDown clamps/card	10	10	5.10 CD
USB FOR 14" – 26" OPENINGS				
522-24	1 bracket	50	50	3.18 EA
522-2404	1 bracket, 4 wood screws	50	50	3.53 EA
522-2414	1 bracket, 1 TouchDown clamp, 4 wood screws	50	50	4.08 EA
522-241463	1 bracket, 1 TouchDown clamp, 4 drill-tip screws	50	50	4.20 EA
522-2420	1 bracket, 2 TouchDown clamps	50	50	4.38 EA
522-2424	1 bracket, 2 TouchDown clamps, 4 wood screws	50	50	4.53 EA
522-24245	1 bracket, 2 TouchDown clamps, 4 zinc plated nails	50	50	4.53 EA
522-242463	1 bracket, 2 TouchDown clamps, 4 drill-tip screws	50	50	4.65 EA
522-2434	1 bracket, 3 TouchDown clamps, 4 wood screws	50	50	5.28 EA
522-242001	50 brackets, 100 TouchDown clamps, bases loaded in brackets, bridges in a bag	1	1	214.00 BG
522-242401	50 brackets, 100 TouchDown clamps, 200 wood screws; bases loaded in brackets, bridges in a bag, screws in a bag	1	1	221.50 BG
TOUCHDOWN CLAMP WITH USB/POWER BAR FOOT				
522-5500	100 bases, 100 bridges, 100 base inserts	100	100	0.43 EA
523F5500	E84: 100 bases, 100 bridges, 100 base inserts	100	100	1.85 EA
522-101	100 bridges	100	100	0.17 EA
522-100B	100 Pipe Down inserts for TouchDown bridge/bag	1	100	31.00 BG
522-5501	1 bridge, 1 base, 1 base insert/bag	100	100	0.61 BG

Nail/Screw Specifications

Wood Screw	#6 × 1" course thread bugle head Phillips
Drill-Tip Screw	#8 × 1" zinc coated drill-tip Phillips
Nail	1½" zinc plated

Bracket Specifications

Span	Safe Working Load
11" span	100 lbs.
16" span	65 lbs.
19" span	40 lbs.
26" span	22 lbs.

TouchDown Specifications

Temp. (°F)	Safe Working Load	
	Black Nylon	E84
-10	70 lbs.	50 lbs.
10		
30		
50		
70		
90	38 lbs.	35 lbs.
110		25 lbs.
130		
150	12 lbs.	NOT RECOMMENDED for ANY load
170		
190		
210	NOT RECOMMENDED for ANY load	
230	NOT RECOMMENDED for ANY load	
Clamp Capacity	¼" O.D.–1⅛" O.D.	
Flame Rating	UL94 V-2 rated	UL94 V-0 rated



SUPPLY

DRAINAGE

SUPPORT

TESTING

SPECIALTIES

TOOLS

ACCESS



Power Bar™ Universal Slider Bracket

Patent Nos. 6,446,915 and 6,402,096

- Galvanized steel bracket and tough nylon clamp is strong and supports pipe without bowing
- Available with one, two, or three TouchDown clamps pre-loaded to reduce installation time
- Smaller bracket expands to fit openings from 9" to 16"
- Larger bracket expands to fit openings from 14" to 26"



Drop ear: screw directly to the bracket for solid shower arms.



Tub/shower valve: fast, secure, and professional installations.

Overlap the Bracket. The bracket should overlap a minimum of 2" in center.

Cinch Evenly. Use pliers to evenly "bow the bridge" for maximum clamp tension.

Fasten Securely. We recommend fastening with screws in all four tabs when installing.



Large pipe: use TouchDown II clamps for pipe up to 2".



Wall bracket: use as a pipe standoff and organizer.



Bend tabs and expand bracket to fit stud bay opening.



Fasten both tabs on each end. Tabs will attach flush with, or inside studs/joists.

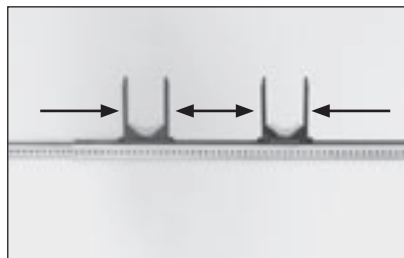

Slide TouchDown clamps anywhere along bracket to align with position of tube.



Place tube inside clamps and cinch the bridge down evenly over posts to secure.

Power Bar™
Universal Slider Bracket

Patent Nos. 6,446,915 and 6,402,096

Shorter Power Bar & Self-Nailing Tabs available Spring 2007

TouchDown™
Universal Pipe Clamp

- Clamps ¼"–1" CTS tube and ½"–1" Sch. 40 pipe
- Optional Pipe Down noise absorption blocks available
- E84 models meet ASTM E84 25/50 and UL94 V-0

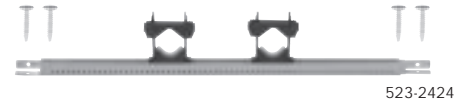

New models with self-nailing tabs (available Spring 2007) can be driven directly into wood studs for a faster installation.

Screw Specifications

Drill-Tip Screw #8 x 1" zinc coated drill-tip Phillips

Bracket Specifications

Span	Safe Working Load*
14" span	150 lbs.
17" span	115 lbs.
21" span	80 lbs.
24" span	45 lbs.

Galvanized steel – 20 ga.

TouchDown & TouchDown II Specifications

Temp (°F)	Safe Working Load			
	Black Nylon TouchDown	Black Nylon TouchDown II	E84 TouchDown	E84 TouchDown II
-10	70 lbs.	150 lbs.	50 lbs.	50 lbs.
10				
30				
50			35 lbs.	35 lbs.
70			25 lbs.	25 lbs.
90	38 lbs.	105 lbs.	50 lbs.	50 lbs.
110				
130				
150				
170	12 lbs.	70 lbs.	50 lbs.	50 lbs.
190				
210				
230	NOT RECOMMENDED for ANY load			



Clamp Range	Black Nylon TouchDown	Black Nylon TouchDown II	E84 TouchDown	E84 TouchDown II
0.375"–1.315"	5/8"–2 3/8" with inserts: 7/8"–2 3/8"	5/8"–2 3/8"	0.375"–1.315"	5/8"–2 3/8"

Flame Rating	UL94 V-2 rated	UL94 V-0 rated

Item No.	Description	Min. Qty.	Case Qty.	List Price
POWER BAR FOR 9"–16"				
523-16	1 bracket	50	50	3.00 EA
523-16N	1 bracket with self-nailing tabs	50	50	3.00 EA
523-1604	1 bracket, 6 drill-tip screws	50	50	3.35 EA
523-1610	1 bracket, 1 TouchDown clamp	50	50	3.75 EA
523-1614	1 bracket, 1 TouchDown clamp, 4 drill-tip screws	50	50	3.90 EA
523-1620	1 bracket, 2 TouchDown clamps	50	50	4.20 EA
523-1620N	1 bracket with self-nailing tabs, 2 TouchDown clamps	50	50	4.20 EA
523-1624	1 bracket, 2 TouchDown clamps, 4 drill-tip screws	50	50	4.35 EA
523-1630	1 bracket, 3 TouchDown clamps	50	50	4.95 EA
523-1634	1 bracket, 3 TouchDown clamps, 4 drill-tip screws	50	50	5.10 EA
523-162001	50 brackets, 100 TouchDown clamps; bases loaded into bracket, bridges in bag	1	1	205.00 BG
523-162401	50 brackets, 100 TouchDown clamps, 200 drill-tip screws; bases loaded into bracket, bridges in bag, screws in a bag	1	1	212.50 BG
POWER BAR FOR 14"–26"				
BULK				
523-24	1 bracket	50	50	3.90 EA
523-24N	1 bracket with self-nailing tabs	50	50	3.90 EA
523-2404	1 bracket, 6 drill-tip screws	50	50	4.25 EA
523-2414	1 bracket, 1 TouchDown clamp, 4 drill-tip screws	50	50	4.80 EA
523-2420	1 bracket, 2 TouchDown clamps	50	50	5.10 EA
523-2420N	1 bracket with self-nailing tabs, 2 TouchDown clamps	50	50	5.10 EA
523F2424	1 bracket, 2 E84 TouchDown clamps, 4 drill-tip screws	50	50	7.25 EA
523-2424	1 bracket, 2 TouchDown clamps, 4 drill-tip screws	50	50	5.25 EA
523-2434	1 bracket, 3 TouchDown clamps, 4 drill-tip screws	50	50	6.00 EA
523-242001	50 brackets, 100 TouchDown clamps; bases loaded into bracket, bridges in bag	1	1	250.00 BG
523-242401	50 brackets, 100 TouchDown clamps, 200 drill-tip screws; bases loaded into bracket, bridges in bag, screws in a bag	1	1	257.50 BG
BAR-CODED BAGS IN A CUT CASE BOX				
523-2424PK2	Set of 1 bracket, 2 TouchDown clamps, 4 drill-tip screws, 4/bag	12	12	19.00 BG
KITS				
523-1K52000	Chase Bracket Kit: 1 single-section Power Bar bracket, 2 TouchDown clamps, 1 DWV Saddle Clamp, one 5" stainless steel band	10	10	5.46 KT
TOUCHDOWN CLAMP WITH USB/POWER BAR FOOT				
522-5500	100 bases, 100 bridges, 100 base inserts	100	100	0.43 EA
523F5500	E84: 100 bases, 100 bridges, 100 base inserts	100	100	1.85 EA
522-101	100 bridges	100	100	0.17 EA
522-100B	100 Pipe Down inserts for TouchDown bridge/bag	1	100	31.00 BG
522-5501	1 bridge, 1 base, 1 base insert/bag	100	100	0.61 BG
ZIPSTRAP WITH POWER BAR FOOT ADAPTER				
523-01	1 nylon ratchet-locking strap with nylon Power Bar foot adapter and screw	10	50	1.92 EA

Brackets

CATALOG 2007

SUPPLY



DRAINAGE



Bend both tabs to inset mount, or one tab to mount to face of stud.

SUPPORT

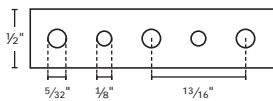

Edge™ Steel Support Bracket

- 20 gauge plain steel or copper plated for spot soldering. (Heat the tube, not the bracket)
- Angle design provides a rigid cross brace between studs
- Use #10 or #12 screw for 5/32" holes, use #8 or #10 screw for 3/16" holes

Item No.	Description	Min. Qty.	Case Qty.	List Price
BULK				
520-16	16" × 1/2" × 1/2", plain steel	100	100	1.00 EA
520-16C	16" × 1/2" × 1/2", copper plated steel	100	100	1.31 EA
520-1624	24" × 1/2" × 1/2", copper plated steel (2 brackets welded in alignment)	100	100	3.65 EA
520-165020Q	16" × 1/2" × 1/2", galvanized steel, with 1 TouchDown II clamp, 2 screws, 2 Pipe Down noise blocks	100	100	4.00 EA
INDIVIDUALLY BAR-CODED IN A CUT CASE BOX				
520-16CPK	16" × 1/2" × 1/2", copper plated steel	100	100	1.65 EA

Support Bracket

Galvanized Steel

- 5/8" wide, 15 gauge

Item No.	Length	Min. Qty.	Case Qty.	List Price
525-18	18"	100	100	1.00 EA
525-20	20"	100	100	1.10 EA
525-26	26"	100	100	1.25 EA

TESTING

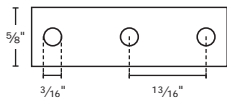

SPECIALTIES



TOOLS

ACCESS

Slider™ Adjustable Support Bracket

- Two-piece design adjusts to a range of openings
- 20 gauge plain steel or copper plated for spot soldering. (Heat the tube, not the bracket)
- Pre-drilled models have 1/8" pilot holes on 13/64" centers

Item No.	Description	Min. Qty.	Case Qty.	List Price
STANDARD FLAT SURFACE WITH SELF-NAILING TABS				
BULK				
520-19	12"-19", galvanized steel	50	50	1.24 EA
520-19C	12"-19", copper plated	50	50	2.30 EA
520-24	19"-24" (3 pieces), galvanized steel	25	25	1.68 EA
520-24C	19"-24" (3 pieces), copper plated	25	25	2.80 EA
INDIVIDUALLY BAR-CODED IN A CUT CASE BOX				
520-19PK	12"-19", galvanized steel	50	50	1.55 EA
520-19CPK	12"-19", copper plated	50	50	2.88 EA
STANDARD FLAT SURFACE WITH STRAIGHT TABS				
520-19T	12"-19", galvanized steel	50	50	1.41 EA
520-19TC	12"-19", copper plated	50	50	2.36 EA
PRE-DRILLED WITH SELF-NAILING TABS				
520-419	12"-19", galvanized steel	50	50	2.47 EA
520-419C	12"-19", copper plated	50	50	3.40 EA
PRE-DRILLED WITH STRAIGHT TABS				
520-419T	12"-19", galvanized steel	50	50	2.47 EA
520-419TC	12"-19", copper plated	50	50	3.41 EA



Stub Out Bracket

Secure-All™ Copper Plated Bracket

Patent # 7,039,965

- Reduce inventory and simplify buying
- Stiffening ribs on top and bottom for ultimate rigidity
- Heavy gauge copper plated steel
- All holes and notches are extruded for maximum soldering surface
- Bracketing area for 521-851 is 14"; for 521-852 is 22"
- Heat the tube, not the bracket



521-851



521-852

Item No.	Dimensions	Holes	Notches	Gauge	Min. Qty.	Case Qty.	List Price
BULK							
521-851	2" x 20"	½" CTS, 2" O.C. (7) ¾" CTS, 2" O.C. (6)	½" CTS, 2" O.C. (7)	20	50	50	2.50 EA
521-852	2¾" x 26"	½" CTS, 2" O.C. (11) ¾" CTS, 4" O.C. (5) 1" CTS, 4" O.C. (5)	½" CTS, 2" O.C. (11) ¾" CTS, 2" O.C. (10)	18	50	50	4.25 EA
INDIVIDUALLY BAR-CODED IN A CUT CASE BOX							
521-851PK	2" x 20"	½" CTS, 2" O.C. (7) ¾" CTS, 2" O.C. (6)	½" CTS, 2" O.C. (7)	20	50	50	2.80 EA



Copper Plated

- Extruded model provides four times the soldering surface for extra strength
- Heat the tube, not the bracket

Item No.	Dimensions	Holes	Extruded Holes	Gauge	Min. Qty.	Case Qty.	List Price
BULK							
521-118	1¼" x 20"	½" CTS, 2" O.C. (8)		16	50	50	2.94 EA
521-118R	1¼" x 20"	½" CTS, 2" O.C. (7)	✓	16	25	25	3.25 EA
521-126	1¼" x 26"	½" CTS, 2" O.C. (8)		16	50	50	4.89 EA
521-810	1¾" x 20"	½" CTS, 2" O.C. (7) ¾" CTS, 4" O.C. (4) 1" CTS, 4" O.C. (4)		16	50	50	3.85 EA
521-820	1¾" x 20"	½" CTS, 2" O.C. (7) ¾" CTS, 4" O.C. (4) 1" CTS, 4" O.C. (3)	✓	24	50	50	3.65 EA
INDIVIDUALLY BAR-CODED IN A CUT CASE BOX							
521-810PK	1¾" x 20"	½" CTS, 2" O.C. (7) ¾" CTS, 4" O.C. (4) 1" CTS, 4" O.C. (4)		16	50	50	4.20 EA



521-118



521-810



Galvanized

- For use with Pipe Eye insert grommets

Related Products
Pipe Eye p 191
Suspensulator p 191

Item No.	Dimensions	Holes	Gauge	Min. Qty.	Case Qty.	List Price
521-318	2" x 20"	1 11/32", 2" O.C. (7)	14	50	50	2.73 EA
521-360	2" x 26"	1 11/32", 2" O.C. (11)	14	50	50	3.30 EA



521-318



521-360

Brackets

CATALOG 2007

SUPPLY

DRAINAGE

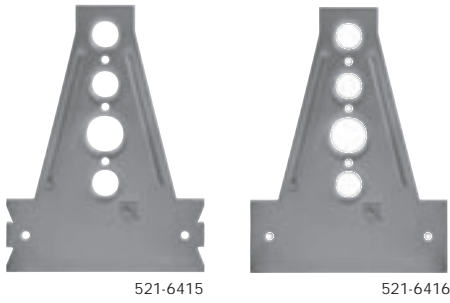

Stub Out Bracket with Stud Guard

Copper Plated

- 16 gauge with built-in stud guard
- A-frame design for added strength
- Positions 1/2" CTS at 2 1/4", 4 3/4" or 6" from floor for water closets and 3/4" CTS at 3 1/2" from floor or side rough for other piping needs

Item No.	Holes	Self-nailing Tabs	Gauge	Min. Qty.	Case Qty.	List Price
521-6415	1/2" CTS (3) 3/4" CTS (1)	✓	16	25	25	2.71 EA
521-6416	1/2" CTS (3) 3/4" CTS (1)		16	25	25	2.71 EA



SUPPORT

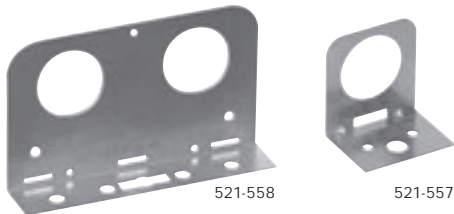

Pipe Eye Suspension Bracket™

Galvanized Steel

- Supports copper, PEX, or CPVC tubing
- Includes one, two, or four 1 1/2" holes
- Multiple nail holes and slots for installation flexibility

TESTING

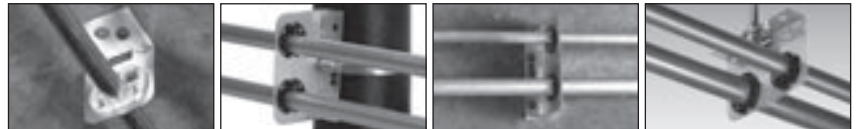

Related Products	
Pipe Eye	p 191
Suspensulator	p 191
Tube Insulator	p 198

SPECIALTIES

Specifications	
Maximum Load	25 lbs.
Material	21 gauge galvanized steel



Item No.	Description	Gauge	Min. Qty.	Case Qty.	List Price
521-557	Single hole	21	25	25	0.80 EA
521-558	Dual hole	21	25	25	0.90 EA
521-559	Quadruple hole	21	25	25	1.25 EA

TOOLS

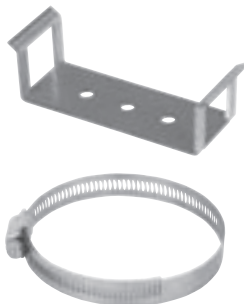

Saddle-Up™

DWV Saddle Clamp



Use with Power Bar or mount to wall

Related Products	
Power Bar	p 213

ACCESS



Item No.	Description	Min. Qty.	Case Qty.	List Price
523-1	Galvanized steel DWV saddle clamp	50	50	1.14 EA
523-1B	Galvanized steel DWV saddle clamp, 5" snap-lock stainless steel band	5	50	2.96 EA
574-72	5" standard stainless steel band	50	50	1.77 EA
574-104	7" snap-lock stainless steel band	50	50	2.73 EA

Carrier Bracket

Copper Plated

- Channel design and extruded 1" CTS hole offer maximum strength and rigidity
- Supports water pipe for flush valve 26 1/2" above floor and offsets flush valve 4 1/2" from carrier center
- Washers included

Item No.	Dimensions	Holes	Gauge	Min. Qty.	Case Qty.	List Price
521-726	1" x 23 1/4"	1" CTS extruded hole (1) 5/8" flat holes (4) 5/8" x 4 1/2" and 2 1/2" bolt slots (2)	16	5	5	9.27 EA



Positioning Bracket

Copper Plated with Stainless Steel Band

- Positions both vertical and horizontal pipes
- Attaches to vent or waste pipe
- Four 1 11/32" holes are not extruded
- 16 gauge

Related Products
Pipe Eye p 191

Item No.	Dimensions	Holes	Notches	Min. Qty.	Case Qty.	List Price
521-110	3" x 9" x 3/4"	1/2" CTS, 4" O.C. (2) 1/2" CTS, 8" O.C. (2) 1 11/32", 4" O.C. (2) 1 11/32", 8" O.C. (2)	1/2" CTS, 4" O.C. (4) 3/4" CTS, 8" O.C. (4)	25	25	6.15 EA



NEW Chase Bracket

Copper Plated

Patent Pending

- Cradles copper water headers up to 3" diameter
- May be screwed to wall or attached to stack or vent pipe with stainless steel band
- Spot solder to copper water header. (Heat pipe not bracket)
- Heavy duty 16 gauge
- Available with or without 5" stainless steel band



Install on stack or vent pipe

Item No.	Description	Min. Qty.	Case Qty.	List Price
521-723	Chase bracket with 5" stainless steel band	25	25	6.75 EA
521-723B	Chase bracket	25	25	6.00 EA



Specifications

Maximum Load | 275 lbs.

Brackets

CATALOG 2007

Pipe Titan™ Universal Bracketing System

Patent # 5,303,887

- Preloaded and preloadable for speed and accuracy
- Non-metallic—no electrolysis worries
- Isolates pipe and reduce noise



Specifications

Standard Green Bracket	ABS, U.V. stabilized
Fire Retardant Red Bracket	Fire retardant polystyrene, UL94 V0 flame rating, U.V. stabilized
Standard Clamp & Strap	Natural high-density polyethylene
Fire Retardant Clamp & Strap	White fire retardant PVC, UL94 V0 flame rating
Screws	Zinc coated steel, 5/16" hex/Phillips head 2" (strap) and 4" (clamp)
Stainless Steel Bands	300 series stainless steel: 1/2" wide x .025 5" band = 5" max diameter 7" band = 7" max diameter Screw: 410 series stainless slotted/hex head

Safe Working Load
When suspended from foot

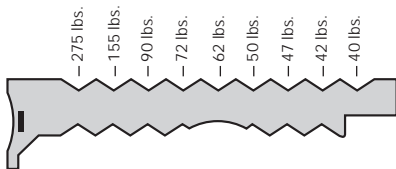

Dimensions

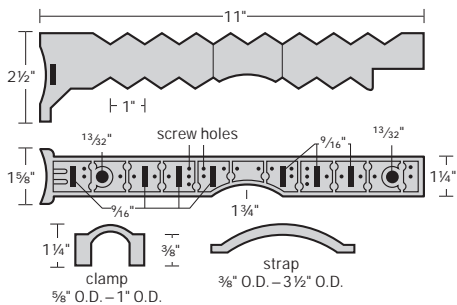

IAPMO file No. 3163
excludes 572-22,
574-72, and 574-75.



Support piping in mechanical chases, against, or standing off of piping, walls, studs, ceilings or floors.

Item No.	Description	Min. Qty.	Case Qty.	List Price
STANDARD GREEN				
BULK				
570	1 standard green bracket	24	24	3.40 EA
570-53	1 Titan strap with screws	50	50	0.96 EA
KITS				
570-10	Kit: 1 bracket, 2 straps, 1 clamp	24	24	6.45 KT
570-20	Plus 5L kit: 1 bracket, 2 straps, 1 clamp, one 5" stainless steel band	24	24	7.80 KT
570-22	Plus 5L kit: 1 bracket, 2 straps, 1 clamp, one 5" stainless steel snap-lock band	24	24	8.63 KT
570-24	Plus 7 kit: 1 bracket, 2 straps, 1 clamp, one 7" stainless steel snap-lock band	24	24	9.26 KT
FIRE RETARDANT RED				
BULK				
572	1 fire retardant red bracket	24	24	5.09 EA
572-53	1 fire retardant Titan strap with screws	50	50	1.11 EA
572-58	1 fire retardant Titan clamp with screws	50	50	1.43 EA
KITS				
572-20	Plus 5 kit: 1 bracket, 2 straps, 1 clamp, one 5" stainless steel band	24	24	10.18 KT
572-22	Plus 5L kit: 1 bracket, 2 straps, 1 clamp, one 5" stainless steel snap-lock band	24	24	11.13 KT
572-24	Plus 7 kit: 1 bracket, 2 straps, 1 clamp, one 7" stainless steel snap-lock band	24	24	11.40 KT
STAINLESS STEEL BANDS				
574-72	5" stainless steel band	50	50	1.77 EA
574-75	5" snap-lock stainless steel band	50	50	2.41 EA
574-104	7" snap-lock stainless steel band	50	50	2.73 EA

Grid Iron™ Universal Bracketing System

Patent # 5,876,000

- Fits inside 2 × 4 wall when strapped to 2" pipe
- 25% stronger than our Pipe Titan
- 1" on-center grooves in bracket
- Ideal for island sinks
- Use cable ties as alternate fasteners
- Great pipe organizer for slab jobs

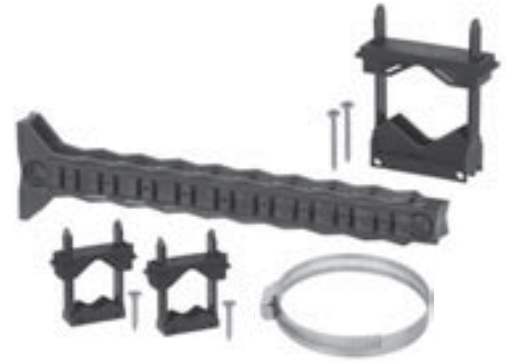

SUPPLY

DRAINAGE

SUPPORT



Perfect for securing tubes of many sizes along mechanical chases.



Use 3/8" (#3) threaded rod for trapeze installations.

Related Products	
PadLock	p 194
TouchDown	p 195
TouchDown II	p 196

Item No.	Description	Min. Qty.	Case Qty.	List Price
GRID IRON BRACKETS				
BULK				
571	1 bracket	24	24	3.00 EA
KITS				
571-10	1 bracket, 2 TouchDown clamps	24	24	3.90 KT
571-145	1 bracket, 2 TouchDown clamps, 1 TouchDown II clamp, one 5" stainless steel band	24	24	6.85 KT
571-20	1 bracket, 2 TouchDown clamps, one 5" stainless steel band	24	24	5.70 KT
571-22	1 bracket, 2 TouchDown clamps, 1 snap-lock 5" stainless steel band	24	24	6.40 KT
STAINLESS STEEL BANDS				
574-72	5" stainless steel band	50	50	1.77 EA
574-75	5" snap-lock stainless steel band	50	50	2.41 EA
574-104	7" snap-lock stainless steel band	50	50	2.73 EA

Specifications

Screw	bugle-head #6 × 1" zinc-coated Phillips
Bracket	100% PVC, fire retardant UL94 VO Flame rating (UL 94)
TouchDown Clamp	100% nylon 66, U.V. resistant UL94 V-2 flame rating Clamps: 3/8" O.D.—1 1/8" O.D. (9.5 mm—28.6 mm)
TouchDown II Clamp	100% nylon 66, U.V. resistant. UL94 V-2 flame rating Clamps: 3/8" O.D.—2 3/8" O.D. (9.5 mm—28.6 mm)
Stainless Steel Bands	300 series stainless steel: 1/2" wide × .025 5" band = 5" max diameter 7" band = 7" max diameter Screw: 410 series stainless slotted/hex head

Safe Working Load

When suspended from foot

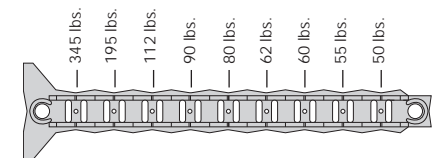

Dimensions

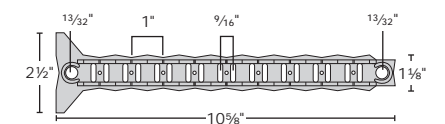

TESTING

SPECIALTIES

TOOLS

ACCESS

Brackets

CATALOG 2007

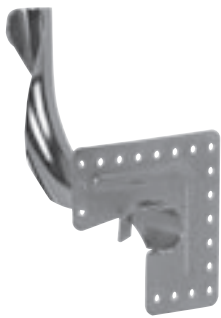

550-MP2



550-M2

SideWinder™ PEX Bend Support

- Forms tight radius 90° bends in PEX tube without kinking
- Nail plate models have unique open corner which allows tube to be inserted after the bracket is installed and after tubing end has been plugged

Item No.	Description	Min. Qty.	Case Qty.	List Price
BULK				
550-M1	3/8" PEX	50	50	0.83 EA
550-M2	1/2" PEX	50	50	0.93 EA
550-MP2	1/2" PEX with nail plate	25	25	2.80 EA
550-M3	3/4" PEX	25	25	1.55 EA
INDIVIDUALLY BAR-CODED IN A CUT CASE BOX				
550-MP2PK	1/2" PEX with nail plate	10	10	3.20 EA



Square O Strap™ Solder Strap™ Copper Eared Tube Hanger

- 1/8" mounting holes align with most conventional brackets
- 17 gauge copper plated steel
- Use as bottom plate to secure risers
- Spot solder to copper tube (Heat tube, not strap)

Item No.	Description	Min. Qty.	Case Qty.	List Price
SQUARE O STRAP				
505-24	1/2" CTS	100	100	0.49 EA
505-34	3/4" CTS	100	100	0.52 EA
SOLDER O STRAP				
505-29	1/2" CTS	100	500	0.45 EA
505-39	3/4" CTS	100	500	0.51 EA
505-49	1" CTS	50	50	0.72 EA



Copper Star™ Locking Tube Nut

- 20 gauge pure copper, 2" O.D.
- Slides over and locks copper tube into place
- Secures copper tube when penetrating walls and floors

Item No.	Description	Min. Qty.	Case Qty.	List Price
BULK				
612-2	1/2" CTS	50	500	1.34 EA
612-3	3/4" CTS	25	250	1.40 EA
612-4	1" CTS	25	250	1.64 EA
BAR-CODED BAGS IN A CUT CASE BOX				
612-2PK2	1/2" CTS, 5/bag	10	10	6.99 BG
612-3PK2	3/4" CTS, 5/bag	10	10	8.45 BG

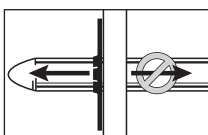

One Copper Star prevents movement in one direction

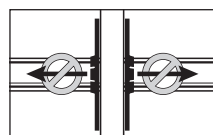

Two Copper Stars prevent movement in either direction

Chieftain EII Clamp™ Elbow Bracket

- Wraps any 1/2" CTS 90° elbow of 1 1/2" radius or less
- Prevents movement in any direction
- Hinges on back and clamps closed over elbow
- High density polyethylene insulates against pipe corrosion and noise transfer



Related Products	
Edge	p 214
USB	p 211
Power Bar	p 213
PEX stub out elbow	p 34

Item No.	Description	Min. Qty.	Case Qty.	List Price
550	1/2" CTS	50	50	0.60 EA



Specifications	
Hanger Body	High Density Polyethylene
Impact resistant	to 0°F (-18 °C).
Maximum Temperature	160°F (71°C) continuous

Stud Shoe

- 16 gauge steel

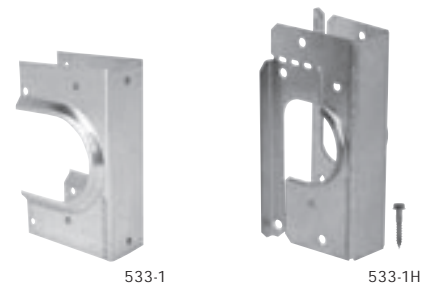

Item No.	Description	A	Min. Qty.	Case Qty.	List Price
BULK					
533-1	Single	1.58"	25	25	2.30 EA
533-2	Double	3.125"	25	25	2.60 EA
533-3	Triple	4.7"	10	10	3.10 EA
533-1H	Single Simpson Strong-Tie HSS stud shoe, galvanized	1.5"	12	12	14.75 EA
533-2H	Double Simpson Strong-Tie HSS stud shoe, galvanized	3"	12	12	15.75 EA
533-3H	Triple Simpson Strong-Tie HSS stud shoe, galvanized	4.5"	12	12	17.50 EA
INDIVIDUALLY BAR-CODED IN A CUT CASE BOX					
533-1PK	Single	1.58"	25	25	2.41 EA
533-2PK	Double	3.125"	25	25	2.71 EA

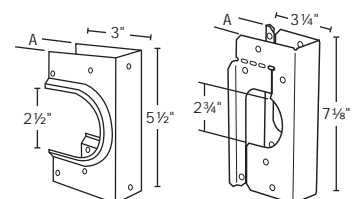

Stud Guard



530-165



530-6M

Item No.	Description	Gauge	Distance Between Nail Points	Min. Qty.	Case Qty.	List Price
BULK						
530-3	1 1/2" x 3" self-nailing	18	2 1/2"	100	100	0.15 EA
530-5	1 1/2" x 5" self-nailing	18	4 1/2"	100	100	0.22 EA
530-6	1 1/2" x 6" self-nailing	18	5 1/2"	100	100	0.233 EA
530-6M	1 1/2" x 6" with nail holes	16	—	100	100	0.233 EA
530-163	1 1/2" x 3" self-nailing	16	2 1/2"	100	100	0.191 EA
530-165	1 1/2" x 5" self-nailing	16	4 1/2"	100	100	0.30 EA
530-166	1 1/2" x 6" self-nailing	16	5 1/2"	100	100	0.28 EA
530-1635	3" x 5" self-nailing, double	16	4 1/2"	100	100	0.48 EA
INDIVIDUALLY BAR-CODED IN A CUT CASE BOX						
530-3PK	1 1/2" x 3" self-nailing	18	2 1/2"	100	100	0.25 EA
530-5PK	1 1/2" x 5" self-nailing	18	4 1/2"	100	100	0.29 EA

Shield Plate



536-09



536-35



539-18

Item No.	Description	Gauge	Nail Holes	Min. Qty.	Case Qty.	List Price
BULK						
536-09	1 1/2" x 9"	16	8	50	50	0.57 EA
536-12	1 1/2" x 12"	16	8	50	50	0.72 EA
536-18	1 1/2" x 18"	16	16	50	50	1.08 EA
536-35	3" x 5" offset self-nailing	16	—	100	100	0.50 EA
536-36	3 1/2" x 6" self-nailing	16	—	50	50	0.75 EA
536-58	5" x 8" self nailing, with nail holes	16	3	50	50	1.60 EA
536-85	5" x 8"	16	6	50	50	1.55 EA
536-612	6" x 12"	16	16	25	25	2.15 EA
538-09	1 1/2" x 9"	18	8	50	50	0.49 EA
538-12	1 1/2" x 12"	18	8	50	50	0.60 EA
538-18	1 1/2" x 18"	18	8	50	50	0.93 EA
539-6	3 1/2" x 6"	16	6	50	50	0.75 EA
539-18	3 1/2" x 18"	16	16	50	50	2.19 EA
539-518	5" x 18"	16	16	25	25	3.42 EA
INDIVIDUALLY BAR CODED IN A CUT CASE BOX						
536-85PK	5" x 8"	16	6	50	50	1.60 EA
538-09PK	1 1/2" x 9"	18	8	50	50	0.54 EA

SUPPLY

DRAINAGE

SUPPORT

TESTING

SPECIALTIES

TOOLS

ACCESS

CATALOG 2007

Testing

Plugs & Caps
Gauges
Equipment



Testing

PLUGS & CAPS

- 225 Test Titan™ Mechanical Test Plug
- 225 Test Titan™ Cleanout Test Plug
- 226 Test Titan™ Pneumatic Test Plug
- 226 Hand Tite™
- 227 Mechanical Test Device
 - Test Tee Mechanical Test Plug (TTMP)
- 227 CPVC Mechanical Test Plug
- 228 Inflatable Test Tee Plug
- 228 Inflatable Test Plug
- 229 Grip Tip™
- 230 Flexible PVC Test Cap
- 230 Knockout Test Plug & Cap
- 230 Quick Plug™

GAUGES

- 231 Gas Test Gauge
- 231 Test Assemblies
- 231 WOG Pressure Gauge

EQUIPMENT

- 232 Handy Pump™
- 232 High-Pressure Hand Pump
- 232 Water Tester

SUPPLY

DRAINAGE

SUPPORT

TESTING

SPECIALTIES

TOOLS

ACCESS

Test Titan™ Mechanical Test Plug

- For head tests
- Provides a leak-free seal at over EIGHT times the PSI of other mechanical test plugs
- High-pressure performance—economical price
- Back-to-front wedge design prevents blowouts at high and low temperatures
- Non-slip shoulder for fast, easy installations

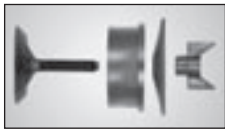

Polypro wingnut, nylon top plate, soft PVC gasket and nylon base/stem for simplicity and strength.

Item No.	Description	Min. Qty.	Case Qty.	List Price
BULK				
882-1B	1 1/2" test plug	100	100	2.80 EA
882-2B	2" test plug	100	100	3.20 EA
882-3B	3" test plug	50	50	4.60 EA
882-4B	4" test plug	50	50	5.95 EA
INDIVIDUALLY BAR-CODED IN A CUT CASE BOX				
882-1	1 1/2" test plug	10	10	2.85 EA
882-2	2" test plug	10	10	3.25 EA
882-3	3" test plug	10	10	4.65 EA
882-4	4" test plug	10	10	6.00 EA



Specifications

Size	Relative Blowout Ratings		
	72°F	15°F	0°F
1 1/2"	65 PSI	55 PSI	42 PSI
2"	65 PSI	25 PSI	10 PSI
3"	45 PSI	11 PSI	7 PSI
4"	42 PSI	10 PSI	8 PSI

Test Titan™ Cleanout Test Plug

- For cleanouts
- Seals 1 1/2"–4" female cleanout threads
- Ideal for use on damaged cleanout openings and on damaged or deteriorated threads

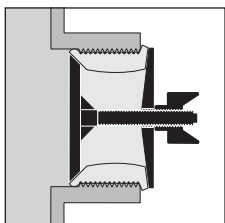

Soft PVC gasket forms an air-tight seal behind and into female cleanout threads.

Item No.	Description	Min. Qty.	Case Qty.	List Price
INDIVIDUALLY BAR-CODED IN A CUT CASE BOX				
882-11	1 1/2" cleanout plug	10	10	4.80 EA
882-21	2" cleanout plug	10	10	5.20 EA
882-35	3 1/2" cleanout plug	10	10	7.05 EA
882-41	4" cleanout plug	10	10	8.25 EA



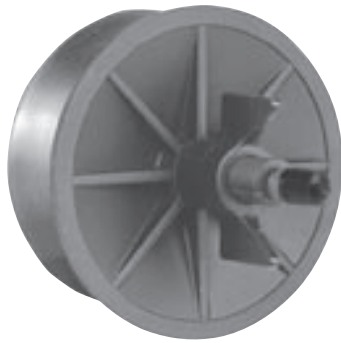

Test Titan™ Pneumatic Test Plug

- For air tests
- Employs a hollow, bored bolt stem and threaded brass air filler valve
- Simply insert, tighten, and inflate. The non-slip shoulder prevents the gasket from spinning



A bored bolt stem and integral brass air valve make the pneumatic Test Titan an easy alternative to standard water head pressure tests.

Related Products

Handy Pump p 232
High-Pressure Hand Pump p 232

Specifications

Size	Relative Blowout Ratings		
	72°F	15°F	0°F
1½"	65 PSI	55 PSI	42 PSI
2"	65 PSI	25 PSI	10 PSI
3"	45 PSI	11 PSI	7 PSI
4"	42 PSI	10 PSI	8 PSI

Item No.	Description	Min. Qty.	Case Qty.	List Price
882-1P	1½" pneumatic test plug with air valve	10	10	15.50 EA
882-2P	2" pneumatic test plug with air valve	10	10	15.75 EA
882-3P	3" pneumatic test plug with air valve	10	10	17.00 EA
882-4P	4" pneumatic test plug with air valve	10	10	18.25 EA



SUPPLY

DRAINAGE

SUPPORT

TESTING

SPECIALTIES

TOOLS

ACCESS



Hand Tite™ Mechanical Test Plug

- For 4"–6" models, use ¾" male garden hose thread adapter and drill-out wall on stem for water or air by-pass tests
- For 8" model, tap stem ½" NPT and drill through bulk head to allow for water or air by-pass tests
- Nylon body and ASTM 361 rubber gasket

Specifications

Pipe	Relative Blowout Ratings
Vitrified pipe	10 PSI
A/C pipe	8 PSI
ABS/PVC pipe	5 PSI

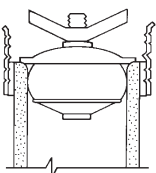

Item No.	Description	Min. Qty.	Case Qty.	List Price
882-94	4" large diameter test plug	1	1	17.50 EA
882-95	5" large diameter test plug	1	1	23.25 EA
882-96	6" large diameter test plug	1	1	25.00 EA
882-98	8" large diameter test plug	1	1	55.00 EA

NEW Mechanical Test Device

Test Tee Mechanical Test Plug (TTMTP)

- Designed to work on cast iron as well as plastic pipe waste systems
- No couplings to mess with
- Perfect for high rise construction—will hold 14 floors of pressure
- Insert into pipe through test tee
- Lock in place for test. When test is complete, release with no water spillage
- Replacement seals available

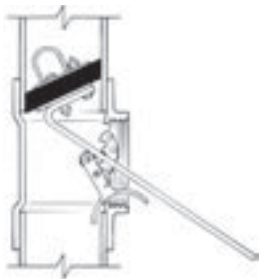

Completely mechanical device that does not need to be filled with air or water

Item No.	Size	Min. Qty.	Case Qty.	List Price
MECHANICAL TEST PLUG				
881-52	2" mechanical test plug	1	5	52.00 EA
881-53	3" mechanical test plug	1	5	61.00 EA
881-54	4" mechanical test plug	1	5	70.00 EA
881-56	6" mechanical test plug	1	1	182.00 EA
881-58	8" mechanical test plug	1	1	412.00 EA
881-510	10" mechanical test plug	1	1	568.00 EA
PLUG REPLACEMENT SEAL				
881-01-2	2" plug replacement seal	5	5	19.00 EA
881-01-3	3" plug replacement seal	5	5	24.00 EA
881-01-4	4" plug replacement seal	5	5	32.00 EA
881-01-6	6" plug replacement seal	2	2	46.00 EA
881-01-8	8" plug replacement seal	2	2	58.00 EA
881-01-10	10" plug replacement seal	1	1	109.00 EA

CPVC Mechanical Test Plug

- Use with Sioux Chief CPVC transition fittings only

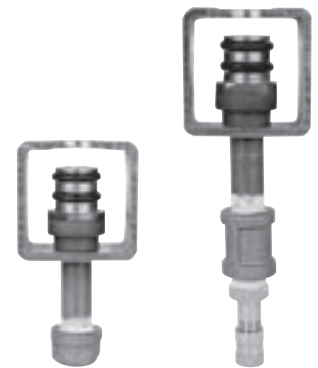

Item No.	Description	Min. Qty.	Case Qty.	List Price
307-2	Mechanical test plug for 1/2" CPVC socket	10	10	20.00 EA
307-2P	Mechanical test plug with air valve for 1/2" CPVC socket	10	10	25.50 EA





Inflatable Test Tee Plug

- Threads into test tee for safety
- No test water backsplash
- Seals the branch and run portions of the tee at the same time
- No need for thread sealant

Related Products
 Handy Pump p 232
 High-Pressure Hand Pump p 232

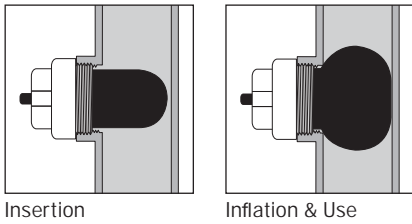

Insertion

Inflation & Use

Item No.	Description	Inflation Pressure	Max Back Pressure	Min. Qty.	Case Qty.	List Price
INDIVIDUALLY BAR-CODED BULK						
882-TT2	2" inflatable plug	40 PSIG	5 PSIG air 30 ft. hd. water	1	1	45.00 EA
882-TT3	3" inflatable plug	40 PSIG	5 PSIG air 30 ft. hd. water	1	1	50.00 EA
882-TT4	4" inflatable plug	40 PSIG	5 PSIG air 30 ft. hd. water	1	1	57.75 EA



Inflatable Test Plug

- Long and short models enable testing on any DWV system 1 1/4"–6"
- Superior design – concave bottom increases contact area and reduces the likelihood of plug blowout
- Bell shaped ribs for superior seal, even if plug is installed at an angle
- Zinc plated ring and durable cable for easy removal after deflation

Related Products
 Handy Pump p 232
 High-Pressure Hand Pump p 232

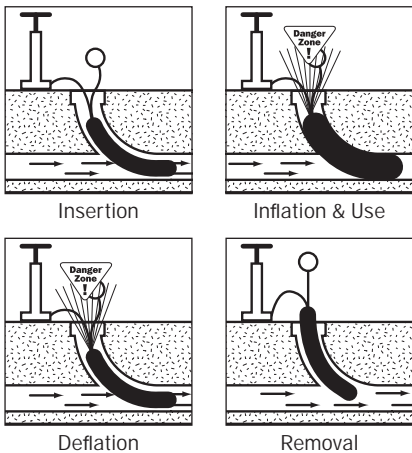

Insertion

Inflation & Use

Deflation

Removal

Item No.	Description	Pipe Diameter	Inflation Pressure (PSIG)	Max Back Pressure	Min. Qty.	Case Qty.	List Price
INFLATABLE TEST PLUGS							
INDIVIDUALLY BAR-CODED BULK							
882-ES12	1 1/2"–2" × 5 1/2" long	1.17" min 2.25" max	45	5 PSIG air 30 ft. hd. water	1	1	43.25 EA
882-ES23	2"–3" × 5" long	1.75" min 3.25" max	45	5 PSIG air 30 ft. hd. water	1	1	45.00 EA
882-ES34	3"–4" × 7 1/4" long	2.88" min 4.25" max	40	5 PSIG air 30 ft. hd. water	1	1	44.00 EA
882-ES46	4"–6" × 10 1/4" long	3.77" min 6.25" max	35	5 PSIG air 30 ft. hd. water	1	1	105.50 EA
882-EL23	2"–3" × 22" long	1.75" min 3.25" max	45	10 PSIG air 30 ft. hd. water	1	1	123.50 EA
882-EL34	3"–4" × 25" long	2.88" min 4.25" max	40	10 PSIG air 30 ft. hd. water	1	1	147.50 EA
882-EL46	4"–6" × 29 1/2" long	3.77" min 6.25" max	35	10 PSIG air 30 ft. hd. water	1	1	295.00 EA

SUPPLY

DRAINAGE

SUPPORT

TESTING

SPECIALTIES

TOOLS

ACCESS

Grip Tip™ Test Cap & Test Plug

Patent # 6,769,291

- Tip acts as a handle while applying glue and can be snipped to allow filling and bleeding with water or air for testing
- Deeper glue surface ensures a good seal especially on unevenly cut pipe
- Durable, virgin ABS may be glued to pipe with all-purpose glue
- High-visibility models make installed plugs and caps easy to see for ensured removal
- Test nipple is 5/8" O.D.



880-82



881-12



Caps and plugs are available in high-visibility pink



881-02A



881-02H

Always use a 5/8" poly ferrule (supplied) when attaching compression fittings to the Grip Tip.

Item No.	Description	Color	Min. Qty.	Case Qty.	List Price
TEST CAP					
BULK					
880-81	1½" test cap	natural	25	200	0.30 EA
880-82	2" test cap	natural	25	200	0.35 EA
880-83	3" test cap	natural	10	50	0.47 EA
880-84	4" test cap	natural	10	50	0.65 EA
880-81C	1½" test cap	high-visibility	25	200	0.32 EA
880-82C	2" test cap	high-visibility	25	200	0.37 EA
880-83C	3" test cap	high-visibility	10	50	0.49 EA
880-84C	4" test cap	high-visibility	10	50	0.67 EA
INDIVIDUALLY BAR-CODED IN A CUT CASE BOX					
880-81PK	1½" test cap	natural	50	50	0.44 EA
880-82PK	2" test cap	natural	50	50	0.49 EA
880-83PK	3" test cap	natural	25	25	0.61 EA
880-84PK	4" test cap	natural	25	25	0.79 EA
TEST PLUG					
881-10	1½" test plug	natural	25	200	0.30 EA
881-12	2" test plug	natural	25	200	0.35 EA
881-13	3" test plug	natural	10	50	0.47 EA
881-14	4" test plug	natural	10	50	0.62 EA
881-10C	1½" test plug	high-visibility	25	200	0.32 EA
881-12C	2" test plug	high-visibility	25	200	0.37 EA
881-13C	3" test plug	high-visibility	10	50	0.49 EA
881-14C	4" test plug	high-visibility	10	50	0.64 EA
TESTING ACCESSORIES					
881-02A	Air test fitting, 15 PSI gauge 5/8" O.D. comp x Schrader valve	—	1	10	33.50 EA
881-02H	Water test fitting 5/8" O.D. comp x female swivel hose thread	—	1	25	15.00 EA
881-02FP	Replacement 5/8" poly ferrule	—	100	1000	0.58 EA



Remove Test Tip



Air Test



Water Test



Ground-Rough Head Tests



Saw Off Cap



Knock Out & Remove





Flexible PVC Test Cap

- Can be reused or permanent; stainless steel clamp

Item No.	Description	Min. Qty.	Case Qty.	List Price
880-1	1 1/2" flexible PVC test cap	25	25	2.65 EA
880-2	2" flexible PVC test cap	25	25	3.00 EA
880-3	3" flexible PVC test cap	25	25	4.10 EA
880-4	4" flexible PVC test cap	25	25	5.00 EA



881-3

880-012

Knockout Test Plug & Cap

- Standard knockout test plugs solvent weld into PVC or ABS Sch. 40 pipe
- Dual fit knockout test caps solvent weld over 1 1/2" and 2", or 3" and 4" PVC or ABS Sch. 40 pipe

Related Products
Grip Tip test plug & test cap p 229

Item No.	Description	Min. Qty.	Case Qty.	List Price
STANDARD KNOCKOUT TEST PLUG				
881-1	1 1/2" plug	100	1000	0.21 EA
881-2	2" plug	100	1000	0.25 EA
881-3	3" plug	50	500	0.37 EA
881-4	4" plug	50	500	0.50 EA
DUAL FIT KNOCKOUT TEST CAP				
880-012	1 1/2" and 2" Sch. 40 cap	100	500	0.67 EA
880-034	3" and 4" Sch. 40 cap	50	250	1.03 EA

Quick Plug™ 1 1/2" Trap Adapter Test Plug

- Eliminates traditional test plugs
- Allows you to fit the trap adapter tightly against the wall for a clean, professional look
- Requires use of standard or Drip-Free™ 1 1/2" slip joint washer

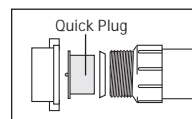

Works with any 1 1/2" trap adapter
Allows installation of the trap adapter during rough-in. No more getting glue and cleaner inside the vanity.

Related Products
Drip-Free slip joint washer p 253

Item No.	Description	Min. Qty.	Case Qty.	List Price
234-QP	1 1/2" trap adapter test plug	25	100	0.70 EA

SUPPLY

DRAINAGE

SUPPORT

TESTING

SPECIALTIES

TOOLS

ACCESS

Gas Test Gauge

- 2" diameter steel case with a shatter proof face
- Brass plated body with brass air valve
- Replacement gauge and manifold available

Item No.	Description	Min. Qty.	Case Qty.	List Price
GAS TEST GAUGE				
BAR-CODED CLAMSHELLS IN A CUT CASE BOX				
355-15PK1	0-15 lb. gas test gauge	1	10	17.10 EA
355-30PK1	0-30 lb. gas test gauge	1	10	17.10 EA
355-60PK1	0-60 lb. gas test gauge	1	10	17.10 EA
REPLACEMENT PARTS				
BAR-CODED CLAMSHELLS IN A CUT CASE BOX				
355-05PK2	Gas test manifold with air valve, 3/4" FIP connection	1	10	8.80 EA
360-15PK1	0-15 lb. replacement gauge, 1/4" MIP connection	1	10	7.25 EA
360-30PK1	0-30 lb. replacement gauge, 1/4" MIP connection	1	10	8.50 EA
360-60PK1	0-60 lb. replacement gauge, 1/4" MIP connection	1	10	8.50 EA

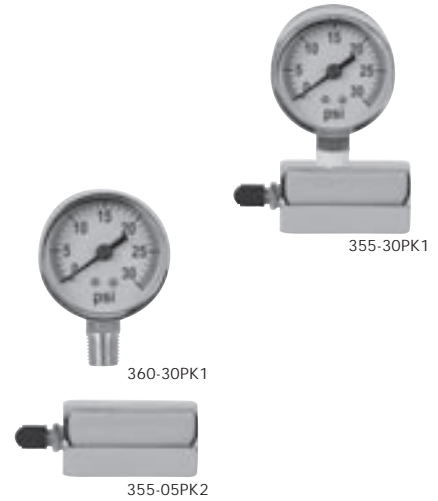

Test Assemblies

Combination Air & Water

- 3/4" female hose swivel
- Schrader valve and 1/4-turn valve
- For testing of supply systems in residential or commercial applications

Air Test Fitting

- 5/8" O.D. comp x Schrader valve
- For testing of supply systems in residential or commercial applications

Water Pressure Test Fitting

- 3/4" brass hose swivel connection
- Use for residential or commercial tests
- Drag pointer indicator for overnight tests

Item No.	Description	Min. Qty.	Case Qty.	List Price
882-105	300 PSI combination air and water test fitting	1	6	58.00 EA
882-110	100 PSI air test fitting	1	6	28.39 EA
360-300PK1	300 PSI water test gauge	1	10	17.99 EA

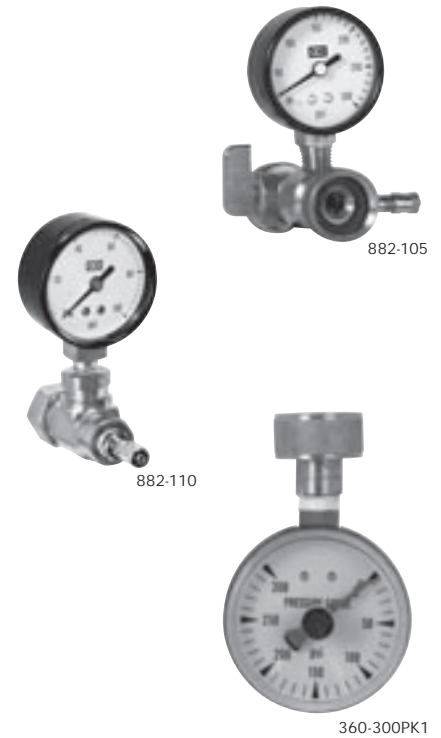

WOG Pressure Gauge

- 1/4" MIP connection
- May be used for water, oil and gas

Item No.	Description	Min. Qty.	Case Qty.	List Price
BAR-CODED CLAMSHELLS IN A CUT CASE BOX				
356-30PK1	0-30 PSI pressure gauge 1/2 lb. grad	1	10	9.99 EA
356-60PK1	0-60 PSI pressure gauge 1 lb. grad	1	10	9.99 EA
356-100PK1	0-100 PSI pressure gauge 1 lb. grad	1	10	9.99 EA
356-160PK1	0-160 PSI pressure gauge 2 lb. grad	1	10	9.99 EA



SUPPLY

DRAINAGE

SUPPORT



12 volt auto adapter and charger included

Handy Pump™ Digital Cordless Air Pump

- 12V Ni-Cad battery
- 150 PSI capacity
- 12V connector for direct voltage supply
- Integral digital pressure gauge
- Digital readout requires two AAA batteries (supplied)
- Complete recharge 4–5 hours
- Great for test balls, expansion tanks, hydrostatic tests
- Trigger action with “lock on” feature

Item No.	Description	Min. Qty.	Case Qty.	List Price
INDIVIDUALLY BAR-CODED				
882-ECPG	Digital cordless air pump with gauge	1	1	85.28 EA
REPLACEMENT PARTS				
882-160	Replacement air hose	1	10	4.00 EA
882-175	Additional battery pack	1	10	35.00 EA
882-180	Additional AC adapter	1	10	15.00 EA

TESTING

SPECIALTIES

TOOLS

ACCESS



High-Pressure Hand Pump

- Maximum pressure 160 PSI
- Various length high-pressure inflation hoses available



Built-in pressure gauge.



Quick release nozzle head.

Item No.	Description	Min. Qty.	Case Qty.	List Price
INDIVIDUALLY BAR-CODED BULK				
882-EHPG	High-pressure hand pump with built-in pressure gauge	1	1	57.50 EA
882-EH24	2 ft. long – ¼" I.D. high-pressure inflation hose	1	1	18.00 EA
882-EH36	3 ft. long – ¼" I.D. high-pressure inflation hose	1	1	20.00 EA
882-EH60	5 ft. long – ¼" I.D. high-pressure inflation hose	1	1	26.25 EA

Water Tester

- Conveniently connects 5/8" O.D. nipple to water supply valve
- 5/8" O.D. compression x 3/4" FHT



Related Products
Ox Box p 303

Item No.	Description	Min. Qty.	Case Qty.	List Price
INDIVIDUALLY BAR-CODED BULK				
881-23CH	Water tester	1	10	31.60 EA

CATALOG 2007

Specialties

Trim
Supply
DWV
Toilet
Log Lighter



Specialties

TRIM

- 235 Trim Tite™
- 236 Snap One™
- 237 Shallow Escutcheon
- 237 Floor & Ceiling Plate
- 238 Tub Spout Escutcheon
- 238 Dry Seal Pipe Collar™
- 239 Faucet Hole Cover
- 239 Universal Tub Valve Escutcheon/Nipple
- 239 Tub Spout
- 240 Tub Face Plate
- 240 Shower Head
- 240 Shower Arm and Accessories
- 241 Shower WallNut™

SUPPLY

- 243 Supply Tube
- 243 Supply Tube Extension
- 244 Supply Step Washer
- 244 Aerator Adapter
- 244 Faucet Aerator
- 244 Hose Washer
- 245 SBR Bibb Washer
- 245 Buna-N O-Ring
- 246 Kitchen Hose
- 246 Pipe Repair Clamp

DWV

- 247 Long Branch™
- 248 Dishwasher Tailpiece
- 248 Major Tee™
- 248 Lavatory Branch Tailpiece
- 249 Brass Sink Tailpiece
- 249 Brass Threaded Tube—T.B.E.
- 249 Slip Joint Extension Tube
- 249 Dishwasher Tailpiece
- 250 Traps
- 250 Poly Sink Tailpiece
- 250 Extension Tube
- 251 End Outlet Waste
- 251 Center Outlet Waste
- 251 Disposal Waste Kit
- 252 Slip Nut
- 252 Two-Piece Slip Nut
- 252 Tailpiece & Slip Washer
- 253 Drip-Free™
- 253 No-Putty Gasket™
- 254 Brass DWV Connector
- 254 DWV Slip Joint Adapter
- 254 Industrial Sink Plug
- 255 Lavatory Drain
- 255 Basin Strainer
- 255 Basin Gasket
- 255 Tub Overflow Gasket
- 256 Hose Clamp
- 256 Anti-Siphon Auto Vent
- 256 Dishwasher Air Gap
- 257 Disposal Parts
- 257 Drain Connector Kit
- 257 Dishwasher Drain Hose

TOILET

- 258 Plumb Perfect™
- 259 Solid Brass Closet Bolt
- 259 Snap-It™
- 259 Closet Bolt Cover Cap
- 260 Smart Cap™
- 260 Tank Bolt Set
- 261 Tank Bowl Kits
- 262 Tank-to-Bowl Gaskets
- 263 Spud Gasket
- 263 Closet Bowl Cushion
- 263 American Standard Actuating Unit
- 263 Plastic Flush Valve
- 264 American Standard Flush Valve Disc
- 264 American Standard Flush Valve Seal
- 264 Mansfield Flush Valve Gasket
- 265 Flappers
- 266 Flush Valve Balls
- 266 Sloan Vacuum Breaker
- 266 Eljer Touch-flush
- 266 Tank Ball & Handle Set
- 267 Tank Handles
- 268 Brass Tank Ball Wire
- 268 Float Ball Rod
- 268 Poly Tank Float Ball
- 268 Anti-siphon Ballcock
- 269 Rubber Ballcock Washer
- 269 Ballcock Repair Kits
- 269 Save-A-Flange™
- 270 Closet Flange Floor Support
- 270 Wedge-It™

LOG LIGHTER

- 271 HearthMaster™ Log Lighter Kits
- 271 HearthMaster™ Log Lighter Bar
- 272 HearthMaster™ Gas Ball Valve
- 273 Log Lighter Accessories

SUPPLY

DRAINAGE

SUPPORT

TESTING

SPECIALTIES

TOOLS

ACCESS

Trim Tite™ Shallow Escutcheon

- Corrosion proof. Will never rust or pit
- Will not come loose. Molded-in "memory" retains a permanent grip on pipe or tube
- Low cost and beautiful appliance white color makes the Trim Tite an excellent substitution for chrome plated or stainless steel escutcheons
- IPS sizes available for steel, PVC and ABS Sch. 40
- 1" CTS and 1" IPS through 2" IPS sizes have deluxe 3½" O.D.

Deep Tubular Escutcheon

- Extra deep 3" , extra wide 4" base
- Perfect for installation behind pedestal lavatories
- Perfect for covering waste-arm adapters



920-2W



921-6W



922-5W



920-2WPK4

Item No.	Description	Dimensions		Min. Qty.	Case Qty.	List Price
		A	B			
ESCUTCHEON						
BULK						
920-1W	⅜" CTS	2½"	⅝"	50	500	0.18 EA
920-2W	½" CTS	2½"	⅝"	25	250	0.18 EA
920-3W	¾" CTS	2½"	⅝"	25	250	0.18 EA
920-4W	1" CTS	3½"	⅝"	20	100	0.43 EA
921-1W	⅜" IPS	2½"	½"	50	500	0.19 EA
921-2W	½" IPS	2½"	½"	50	500	0.20 EA
921-3W	¾" IPS	2½"	½"	50	500	0.22 EA
921-4W	1" IPS	3½"	⅝"	20	100	0.41 EA
921-5W	1¼" IPS	3½"	⅝"	20	100	0.46 EA
921-6W	1½" IPS	3½"	⅝"	20	100	0.39 EA
921-7W	2" IPS	3½"	⅝"	20	100	0.41 EA
BAR-CODED BAGS IN A BAR-CODED DISPENSER BOX						
920-2WPK4	½" CTS, 2/bag, 25 bags/box	2½"	⅝"	1	1	17.14 BX
BAR-CODED BAGS IN A CUT CASE BOX						
920-1WPK2	⅜" CTS, 2/bag	2½"	⅝"	10	10	0.61 BG
920-2WPK2	½" CTS, 2/bag	2½"	⅝"	10	10	0.62 BG
920-3WPK2	¾" CTS, 2/bag	2½"	⅝"	10	10	0.62 BG
920-4WPK2	1" CTS, 2/bag	3½"	⅝"	10	10	1.14 BG
921-1WPK2	⅜" IPS, 2/bag	2½"	½"	10	10	0.63 BG
921-2WPK2	½" IPS, 2/bag	2½"	½"	10	10	0.66 BG
921-3WPK2	¾" IPS, 2/bag	2½"	½"	10	10	0.70 BG
921-4WPK2	1" IPS, 2/bag	3½"	⅝"	10	10	1.16 BG
921-5WPK2	1¼" IPS, 1/bag	3½"	⅝"	10	10	0.63 BG
921-6WPK2	1½" IPS, 1/bag	3½"	⅝"	10	10	0.60 BG
921-7WPK2	2" IPS, 1/bag	3½"	⅝"	10	10	0.62 BG
DEEP ESCUTCHEON						
BULK						
922-5W	1¼" tubular	4"	3"	25	25	0.83 EA
922-6W	1½" tubular	4"	3"	25	25	0.83 EA
INDIVIDUALLY BAR-CODED IN A CUT CASE BOX						
922-5WPK2	1¼" tubular	4"	3"	10	10	1.13 EA
922-6WPK2	1½" tubular	4"	3"	10	10	1.12 EA



No more rust, corrosion or pitting.



Give all your stub outs the professional look of the Trim Tite.



Covers most wall openings. Perfect for installation behind pedestal lavatory.



SUPPLY

DRAINAGE

SUPPORT

TESTING

SPECIALTIES

TOOLS

ACCESS

Trim



926-2



926-2W

Snap One™ Floor and Ceiling Plate

- Available in white or chrome plated ABS
- Split for pre-piped jobs
- 100% rust proof

SUPPLY

DRAINAGE

SUPPORT

TESTING

SPECIALTIES

TOOLS

ACCESS

Item No.	Description	Dimensions		Min. Qty.	Case Qty.	List Price
		A	B			
CHROME PLATED ABS						
BULK						
926-2	1/2" CTS	2 1/2"	3/8"	12	120	1.05 EA
926-3	3/4" CTS	2 3/4"	3/8"	12	120	1.05 EA
926-4	1" CTS	3"	3/8"	12	120	1.18 EA
927-2	1/2" IPS	2 3/4"	3/8"	12	120	1.05 EA
927-3	3/4" IPS	3"	3/8"	12	120	1.06 EA
927-4	1" IPS	3 3/16"	3/8"	12	120	1.17 EA
927-6	1 1/2" IPS	3 3/8"	3/8"	12	120	1.76 EA
927-7	2" IPS	4 3/8"	3/8"	12	120	1.85 EA
BAR-CODED BAGS IN A CUT CASE BOX						
926-2PK2	1/2" CTS, 1/bag	2 1/2"	3/8"	12	12	1.30 BG
926-3PK2	3/4" CTS, 1/bag	2 3/4"	3/8"	12	12	1.30 BG
926-4PK2	1" CTS, 1/bag	3"	3/8"	12	12	1.45 BG
927-2PK2	1/2" IPS, 1/bag	2 3/4"	3/8"	12	12	1.35 BG
927-3PK2	3/4" IPS, 1/bag	3"	3/8"	12	12	1.45 BG
927-4PK2	1" IPS, 1/bag	3 3/16"	3/8"	12	12	1.45 BG
927-5PK2	1 1/4" IPS, 1/bag	3 3/8"	3/8"	12	12	2.11 BG
927-6PK2	1 1/2" IPS, 1/bag	3 3/8"	3/8"	12	12	2.20 BG
927-7PK2	2" IPS, 1/bag	4 3/8"	3/8"	12	12	2.30 BG
WHITE ABS						
BULK						
926-2W	1/2" CTS	2 1/2"	3/8"	12	120	0.70 EA
926-3W	3/4" CTS	2 3/4"	3/8"	12	120	0.74 EA
926-4W	1" CTS	3"	3/8"	12	120	0.85 EA
927-2W	1/2" IPS	2 3/4"	3/8"	12	120	0.73 EA
927-3W	3/4" IPS	3"	3/8"	12	120	0.74 EA
927-4W	1" IPS	3 3/16"	3/8"	12	120	0.84 EA
927-6W	1 1/2" IPS	3 3/8"	3/8"	12	120	1.01 EA
927-7W	2" IPS	4 3/8"	3/8"	12	120	1.00 EA
927-8W	3" IPS	4 3/8"	3/8"	12	120	1.83 EA



Shallow Escutcheon

Chrome Plated Steel

- Sure grip fit



Item No.	Description	Dimensions		Min. Qty.	Case Qty.	List Price
		A	B			
BULK						
910-2	1/2" CTS	2 1/2"	3/8"	25	250	0.28 EA
910-3	3/4" CTS	2 1/2"	1/2"	25	250	0.28 EA
911-2	1/2" IPS	2 1/2"	1/2"	25	250	0.26 EA
911-3	3/4" IPS	2 1/2"	1/2"	25	250	0.28 EA
911-4	1" IPS	2 13/16"	1/2"	25	250	0.46 EA
911-6	1 1/2" IPS (Sch. 40 DWV)	3"	1/2"	25	250	0.48 EA
911-6D	1 1/2" IPS (Sch. 40 DWV)	3 1/2"	3/4"	25	250	0.72 EA
911-7	2" IPS (Sch. 40 DWV)	3 1/2"	5/8"	25	250	0.86 EA
BAR-CODED BAGS IN A CUT CASE BOX						
910-2PK2	1/2" CTS, 2/bag	2 1/2"	3/8"	10	10	0.99 BG
910-3PK2	3/4" CTS, 2/bag	2 1/2"	1/2"	10	10	0.99 BG
911-2PK2	1/2" IPS, 2/bag	2 1/2"	1/2"	10	10	0.90 BG
911-3PK2	3/4" IPS, 2/bag	2 1/2"	1/2"	10	10	0.94 BG
911-4PK2	1" IPS, 2/bag	2 13/16"	1/2"	10	10	1.25 BG
911-6PK2	1 1/2" IPS (Sch. 40 DWV), 1/bag	3"	1/2"	10	10	0.74 BG
911-7PK2	2" IPS (Sch. 40 DWV), 1/bag	3 1/2"	5/8"	10	10	1.05 BG



Floor & Ceiling Plate

Chrome Plated Steel



Item No.	Description	Dimensions	Min. Qty.	Case Qty.	List Price
		A			
BULK					
916-2	1/2" CTS	2 3/8"	12	120	0.94 EA
916-3	3/4" CTS	2 3/8"	12	120	0.94 EA
916-4	1" CTS	2 3/8"	12	120	0.94 EA
917-2	1/2" IPS	2 3/8"	12	120	0.91 EA
917-3	3/4" IPS	2 3/8"	12	120	0.91 EA
917-4	1" IPS	3 5/8"	12	120	1.02 EA
917-6	1 1/2" IPS	3 5/8"	12	120	1.12 EA
BAR-CODED BAGS IN A CUT CASE BOX					
916-2PK2	1/2" CTS, 1/bag	2 3/8"	12	12	1.20 BG
916-3PK2	3/4" CTS, 1/bag	2 3/8"	12	12	1.20 BG
916-4PK2	1" CTS, 1/bag	2 3/8"	12	12	1.20 BG
917-2PK2	1/2" IPS, 1/bag	2 3/8"	12	12	1.15 BG
917-3PK2	3/4" IPS, 1/bag	2 3/8"	12	12	1.15 BG
917-4PK2	1" IPS, 1/bag	3 5/8"	12	12	1.39 BG
917-6PK2	1 1/2" IPS, 1/bag	3 5/8"	12	12	1.40 BG

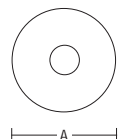

Trim



Tub Spout Escutcheon

- For use with 1/2" CTS, 1/2" or 3/4" IPS
- Chrome plated brass with foam gasket
- Covers unsightly stain marks

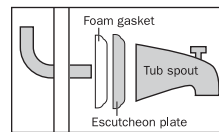

Provides water leak protection between tub spout and wall cavity around stub out.

Item No.	Description	Min. Qty.	Case Qty.	List Price
INDIVIDUALLY BAR-CODED				
972-100	Tub spout seal escutcheon	1	12	8.06 EA

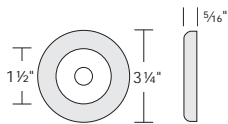

Dry Seal Pipe Collar™
Water/Moisture Barrier

Patent Pending

- Creates a water tight seal around pipe or tube
- Thin, tapered design compresses tightly to wall
- Helps keep moisture out of wall cavity which helps eliminate MOLD growth



928-2

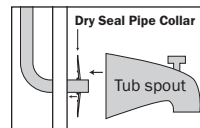

Perfect behind tub spouts or shower arms or any wall penetration. Fits under most escutcheons.

Item No.	Description	Min. Qty.	Case Qty.	List Price
BULK				
928-12	1/2" IPS	50	500	0.23 EA
928-125	1/2" shower arm	50	500	0.23 EA
928-13	3/4" IPS	50	500	0.23 EA
928-2	1/2" CTS	50	500	0.23 EA
928-3	3/4" CTS	50	500	0.23 EA
928-4	1" CTS	25	200	0.44 EA
BAR-CODED BAGS IN A BAR-CODED DISPENSER BOX				
928-2PK4	1/2" CTS , 4/bag, 75 bags/box	1	1	75.17 BX



928-2PK4



SUPPLY

DRAINAGE

SUPPORT

TESTING

SPECIALTIES

TOOLS

ACCESS

Faucet Hole Cover

- 2" cover includes putty cup
- ABS material will not corrode

Item No.	Description	Min. Qty.	Case Qty.	List Price
BULK				
961-6	1¾" cover, chrome plated steel, toggle nut	25	25	1.30 EA
961-7	2" cover, chrome plated steel, wing nut	25	25	1.50 EA
INDIVIDUALLY BAR-CODED				
961-20150	2" cover, chrome plated steel, wing nut	1	25	2.84 EA
961-20155	1¾" white ABS, o-ring seal with wing nut	1	25	3.08 EA
961-20158	1¾" bone ABS, o-ring seal with wing nut	1	25	3.08 EA

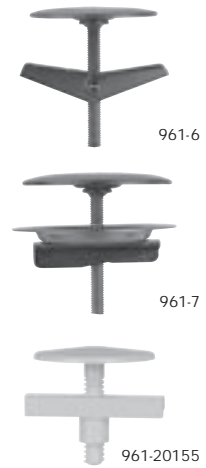

Universal Tub Valve Escutcheon/Nipple

- Universal escutcheon & sleeve kit includes:
 - One 974-60205 fit-all nipple,
 - One ⅝", 24 thread, reversible, tapped, chrome plated sleeve: height adjusts between 1⅞"-2⅝", 2¾" O.D.

Item No.	Description	Min. Qty.	Case Qty.	List Price
FIT-ALL ESCUTCHEON NIPPLE				
974-60205	Multi thread fit-all tub escutcheon nipple: ⅝" x 18; ⅝" x 24; ⅞" x 20 & ⅜" IPS	3	24	1.23 EA
UNIVERSAL ESCUTCHEON KIT				
INDIVIDUALLY BAR-CODED				
291-60230	Chrome plated tub/shower valve escutcheon trim kit: wall plate, sleeve, and fit-all adapter	1	24	5.60 EA



Tub Spout

- Chrome plated zinc

Item No.	Connection	Min. Qty.	Case Qty.	List Price
WITH FRONT DIVERTER				
BULK				
972-15B	½" FIPS nose end	50	50	14.94 EA
972-35B	Slip connects to ⅝" O.D. with 1⅜" adjustment	50	50	18.01 EA
INDIVIDUALLY BAR-CODED				
972-15	½" FIPS nose end	1	10	15.37 EA
972-35	Slip connects to ⅝" O.D. with 1⅜" adjustment	1	10	18.88 EA
NO DIVERTER				
BULK				
972-10B	½" FIPS nose end	50	50	8.08 EA
972-30B	Slip connects to ⅝" O.D. with 1⅜" adjustment	50	50	13.00 EA
INDIVIDUALLY BAR-CODED				
972-10	½" FIPS nose end	1	10	8.61 EA
972-20	¾" or ½" FIPS nose end with ½" x ¾" bushing	1	10	8.46 EA
972-30	Slip connects to ⅝" O.D. with 1⅜" adjustment	1	10	13.97 EA





974-60102



974-60100

Tub Face Plate

Blank

- Two hole chrome plated blank face plate with two screws

Trip Lever

- Two hole tub face plate with two 2" chrome plated screws, and one 3/32" x 3/4" brass cotter key

Item No.	Description	Min. Qty.	Case Qty.	List Price
BLANK				
INDIVIDUALLY BAR-CODED BAG				
974-60102	Blank tub face plate – two hole, chrome plated steel with 2" chrome screws	1	12	4.48 EA
TRIP LEVER FACE PLATE				
INDIVIDUALLY BAR-CODED BAG				
974-60100	Chrome plated Zamac, two-hole with spring, two chrome screws and brass cotter key	1	20	6.64 EA
TRIP LEVER FACE PLATE ACCESSORIES				
974-60105	Screw – 2" chrome plated brass for face plate	6	120	2.05 EA
974-60106	Cotter key – 3/32" x 3/4" brass	10	1000	0.16 EA

Shower Head

Adjustable Spray

- 1 3/4" diameter chrome plated brass
- Adjustable, 2.5 G.P.M. shower head



Item No.	Description	Min. Qty.	Case Qty.	List Price
INDIVIDUALLY BAR-CODED				
974-60300	shower head	1	6	14.89 EA

Shower Arm and Accessories

- Chrome plated finish



974-60315



974-60308

974-60306

974-60304

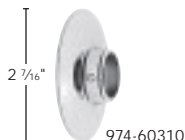

974-60310

2 7/16"

Related Product
Shower WallNut p 241



Item No.	Description	Min. Qty.	Case Qty.	List Price
STANDARD SHOWER ARM				
BULK				
974-60305	4" long x 1/2" MIP	25	25	4.76 EA
974-60307	6" long x 1/2" MIP	25	25	5.30 EA
974-60309	8" long x 1/2" MIP	25	25	5.74 EA
INDIVIDUALLY BAR-CODED				
974-60304	4" long x 1/2" MIP	1	25	5.21 EA
974-60306	6" long x 1/2" MIP	1	25	5.43 EA
974-60308	8" long x 1/2" MIP	1	25	6.16 EA
"S" TYPE SHOWER ARM				
INDIVIDUALLY BAR-CODED				
974-60315	"S" type, 1/2" MIP – 10" rise	1	10	29.70 EA
SHOWER ARM ACCESSORIES				
INDIVIDUALLY BAR-CODED				
974-60310	flange with set screw	1	10	3.16 EA

Shower WallNut™ Shower Arm Adapter

Patent # 6,378,912

- Never install shower arms the hard way again
- Stub out with copper tube, just like other fixtures
- Stub out with copper only when using the Shower WallNut
- Stub-out-to-shower-arm connection is made outside the finished wall. No hidden leaks in the wall which promote mold growth

Replacing Wobbly Shower Arms?

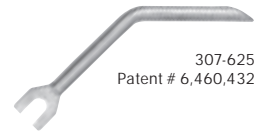
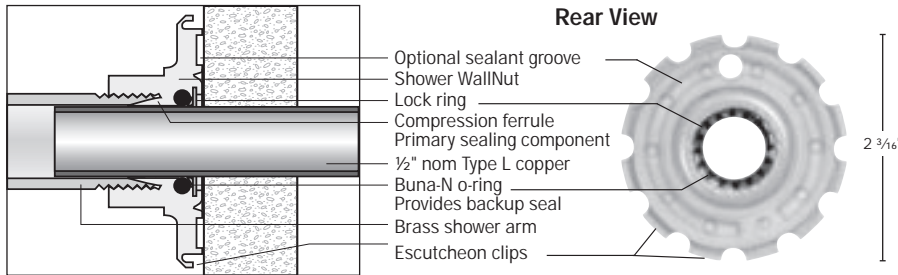

Satin Nickel, Pearl Nickel, and Oil Rubbed Bronze escutcheon finishes

Satin Nickel matches	Delta® Satin Nickel Kohler® Vibrant Brushed Nickel Price Pfister® Brushed Nickel Moen® Brushed Nickel
Pearl Nickel matches	Delta® Pearl Nickel Moen® Satine
Oil Rubbed Bronze matches	Moen® Oil Rubbed Bronze Delta® Venetian Bronze Danze® Oil Rubbed Bronze Price Pfister® Oil Rubbed Bronze

Specifications

Nut	DuPont Zytel™ 40% glass-filled Nylon 66 32,000 PSI tensile strength ½" FIP thread x ⅝" O.D. slip fit.
Lock Ring	Stainless steel
O-ring	Buna-N
Cycle Testing	over 1,000 cycles from 180°F to 60°F at 100 PSI.

Item No.	Description	Escutcheon Finish	Min. Qty.	Case Qty.	List Price
SHOWER WALLNUT KITS					
INDIVIDUALLY BAGGED					
616-02C	WallNut with escutcheon	chrome	25	25	3.80 EA
616-02P	WallNut with escutcheon	polished brass	25	25	4.62 EA
616-02W	WallNut with escutcheon	white enamel	25	25	4.35 EA
616-02C8L	½" MIP x ½" spin closed x 8" long, type L stub out – kit	chrome	25	25	9.19 EA
616-02RB	WallNut with escutcheon	rubbed bronze	1	25	23.40 EA
616-02PN	WallNut with escutcheon	pearl nickel	1	25	10.26 EA
616-02SN	WallNut with escutcheon	satin nickel	1	25	9.90 EA
TOOLS & ACCESSORIES					
INDIVIDUALLY BAGGED					
307-625	Shower Arm Installation Tool	—	1	6	7.10 EA
307-616	WallNut Removal Tool	—	1	10	15.50 EA
974-60304	4" long x ½" MIP shower arm	—	1	25	5.21 EA



Supply Tube

Lav-Sink

- Chrome plated copper or PEX
- Copper tubes are one piece with nylon insert
- 100% PEX tubes have molded head and bagged nylon ferrules

Closet

- Chrome plated copper or PEX
- Copper closet tubes include rubber nose piece

Ferrules

- Brass for copper tubes
- Poly for PEX tubes

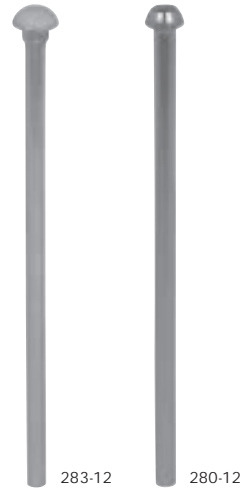

Item No.	Description	Material	Min. Qty.	Case Qty.	List Price
LAV-SINK SUPPLY TUBE					
280-12	3/8" O.D. x 12"	copper	100	100	3.10 EA
280-20	3/8" O.D. x 20"	copper	100	100	4.67 EA
280-36	3/8" O.D. x 36"	copper	50	50	8.23 EA
285-12	3/8" O.D. x 12"	PEX	100	100	0.94 EA
285-20	3/8" O.D. x 20"	PEX	100	100	1.18 EA
285-30	3/8" O.D. x 30"	PEX	100	100	1.47 EA
285-36	3/8" O.D. x 36"	PEX	100	100	1.78 EA
CLOSET SUPPLY TUBE					
283-12	3/8" O.D. x 12" w/rubber nose piece	copper	50	50	3.86 EA
283-20	3/8" O.D. x 20" w/rubber nose piece	copper	50	50	5.44 EA
287-12	3/8" O.D. x 12"	PEX	100	100	0.98 EA
287-20	3/8" O.D. x 20"	PEX	100	100	1.22 EA
FERRULES					
280-100	3/8" nominal	brass	100	2000	0.28 EA
285-100	3/8" nominal	poly	100	10000	0.10 EA



SUPPLY

DRAINAGE

SUPPORT

TESTING

SPECIALTIES

Supply Tube Extension

Copper – 3/8" O.D. Male Sweat x Female Sweat

- Soft copper tube
- Great for faucet change-outs or supply tube extensions

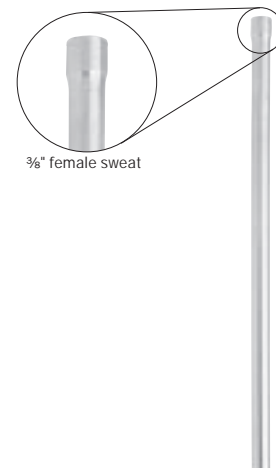

Item No.	Length	Description	Min. Qty.	Case Qty.	List Price
289-12	12"	3/8" O.D. male sweat x female sweat	100	100	1.81 EA
289-20	20"	3/8" O.D. male sweat x female sweat	100	100	2.85 EA

TOOLS

ACCESS

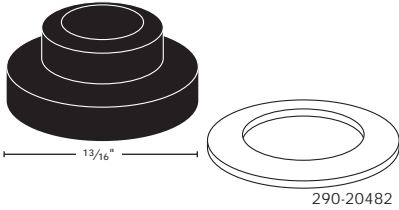
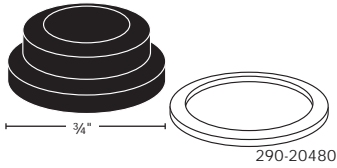

Supply Step Washer

for Lavatory or Closet

- Deluxe rubber lavatory supply washer with brass friction ring

Item No.	Description	Min. Qty.	Case Qty.	List Price
290-20480	Lavatory 3/8" tall	50	500	0.32 EA
290-20482	Closet 7/16" tall	50	500	0.45 EA



Aerator Adapter

- Chrome plated brass
- Replace aerators on old faucets

Item No.	Description	Min. Qty.	Case Qty.	List Price
290-21110	Dual thread (1 5/16" - 27 female thread 5 5/64" male thread) x 3/4" male thread	5	250	3.05 EA



Faucet Aerator

- Chrome plated brass, 2.0 GPM maximum

A112.18.1M

Item No.	Description	Min. Qty.	Case Qty.	List Price
290-21100	Standard combo male/female non-slotted	6	48	2.10 EA
290-21104	1 3/16" x 27 male threaded non-slotted	6	48	2.10 EA



Hose Washer

- Standard rubber hose washer

Item No.	Description	Bag Qty.	Case Qty.	List Price
291-30500	Washer	12	144	0.15 EA

SUPPLY

DRAINAGE

SUPPORT

TESTING

SPECIALTIES

TOOLS

ACCESS

SBR Bibb Washer

Flat

- SRB (synthetic blended rubber)
- Washer kit includes 150 assorted washers with six 10-24 bibb screws
- Washer chest includes over 260 washers in plastic chest complete with snap-in chrome wire holders

Beveled

- SRB (synthetic blended rubber)
- Washer kit includes 150 assorted washers with six 10-24 bibb screws
- Washer chest includes over 160 washers in plastic chest complete with snap-in chrome wire holders

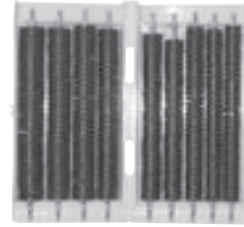

291-30126



291-30125

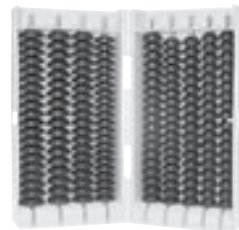

291-30226



291-30225

Item No.	Description	Min. Qty.	Case Qty.	List Price
FLAT WASHER				
INDIVIDUALLY BAR-CODED KITS				
291-30125	SBR flat bibb washer kit	1	1	19.32 KT
291-30126	SBR flat bibb washer chest kit	1	1	36.85 KT
BEVELED WASHER				
INDIVIDUALLY BAR-CODED KITS				
291-30225	SBR beveled bibb washer kit	1	1	19.93 KT
291-30226	SBR beveled bibb washer chest kit	1	1	31.51 KT

Buna-N O-Ring

- Kit includes 150 assorted o-rings in a 12 compartment plastic box



Item No.	Description	Min. Qty.	Case Qty.	List Price
INDIVIDUALLY BAR-CODED KITS				
291-30380	Buna-N o-ring kit	1	10	24.75 KT



242-10

2"



242-20



4 5/8"

242-20106

Kitchen Hose

Spray Kit and Accessories

- Universal coupling connection:
1/8" MIP with 1/8" FIP x 1/4" FIP
- Accessories available in black or white

Item No.	Description	Color	Min. Qty.	Case Qty.	List Price
INDIVIDUALLY BAR-CODED					
242-10	Kit with universal coupling connection	black	1	10	9.64 EA
242-20	Plastic hose guide with stainless steel skirt	black	1	100	1.50 EA
242-25	Universal spray head only	black	1	10	5.26 EA
242-20102	Kit with universal coupling connection	white	1	10	10.08 EA
242-20116	Plastic hose guide with stainless steel skirt	white	1	25	1.50 EA
242-20106	Universal spray head only	white	1	10	5.50 EA

Pipe Repair Clamp

3" One-Bolt

6" Two-Bolt

- For both sizes, stainless steel clamps with EPDM gaskets make them safe for repairs to hot and cold water lines



600-40171



600-40181

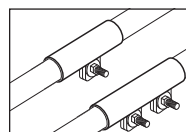

Wraps around pipe to stop leaks.

Item No.	Pipe Size	Min. Qty.	Case Qty.	List Price
3" ONE-BOLT REPAIR CLAMP				
INDIVIDUALLY BAR-CODED BAG				
600-40170	3/8" IPS	6	6	5.36 EA
600-40171	1/2" IPS	6	6	5.36 EA
600-40172	3/4" IPS	6	6	5.57 EA
600-40173	1" IPS	6	6	6.38 EA
600-40174	1 1/4" IPS	6	6	6.88 EA
600-40175	1 1/2" IPS	6	6	8.53 EA
600-40176	2" IPS	6	6	8.66 EA
6" TWO-BOLT EXTRA LONG REPAIR CLAMP				
INDIVIDUALLY BAR-CODED BAG				
600-40181	1/2" IPS	6	6	8.83 EA
600-40182	3/4" IPS	6	6	10.28 EA
600-40183	1" IPS	6	6	10.47 EA
600-40184	1 1/4" IPS	6	6	12.50 EA
600-40185	1 1/2" IPS	6	6	14.65 EA
600-40186	2" IPS	6	6	15.67 EA

Long Branch™ Dishwasher Tailpiece

- Downward inlet eliminates splash-up
- Faster installation—fewer pieces
- Long ½" nominal copper branch provides work space for easy sweat or hose clamp connection
- No connector kits needed
- Quality copper and brass construction

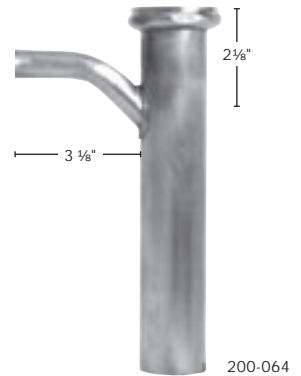

200-064



204-068

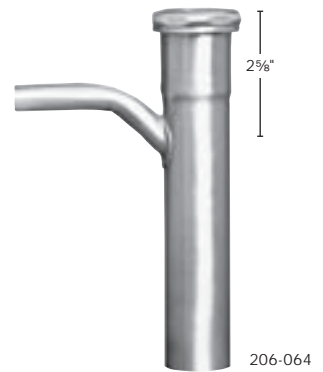

206-064



Item No.	Dimensions	Gauge	Nut Type	Branch Connection	Finish	Min. Qty.	Case Qty.	List Price
DIRECT CONNECTION								
BULK								
200-062	1 ½" × 6"	22	zinc die cast	½" CTS	unfinished	25	25	9.23 EA
200-064	1 ½" × 6"	22	solid brass	½" CTS	unfinished	25	25	9.87 EA
200-066	1 ½" × 6"	22	solid brass	½" CTS	satın	25	25	12.68 EA
200-082	1 ½" × 8"	22	zinc die cast	½" CTS	unfinished	25	25	10.21 EA
200-084	1 ½" × 8"	22	solid brass	½" CTS	unfinished	25	25	11.04 EA
200-102	1 ½" × 10"	22	zinc die cast	½" CTS	unfinished	25	25	11.28 EA
200-104	1 ½" × 10"	22	solid brass	½" CTS	unfinished	25	25	11.91 EA
200-122	1 ½" × 12"	22	zinc die cast	½" CTS	unfinished	25	25	12.19 EA
200-124	1 ½" × 12"	22	solid brass	½" CTS	unfinished	25	25	12.83 EA
INDIVIDUALLY BAR-CODED IN A CUT CASE BOX								
200-124PK	1 ½" × 12"	22	solid brass	½" CTS	unfinished	25	25	12.92 EA
FINE THREAD CONNECTION								
204-068	1 ½" × 6"	20	—	½" CTS	satın	25	25	12.63 EA
SLIP JOINT CONNECTION								
206-064	1 ½" × 6"	22	solid brass	½" CTS	unfinished	25	25	10.67 EA
206-066	1 ½" × 6"	22	solid brass	½" CTS	satın	25	25	13.67 EA
206-084	1 ½" × 8"	22	solid brass	½" CTS	unfinished	25	25	11.50 EA



Dishwasher Tailpiece

- 1 1/2" tube body – 22 gauge
- 7/8" O.D. copper branch



Item No.	Dimensions	Nut Type	Branch Connection	Finish	Min. Qty.	Case Qty.	List Price
DIRECT CONNECT							
210-064	1 1/2" x 6"	solid brass	7/8" O.D.	unfinished	25	25	10.48 EA
210-066	1 1/2" x 6"	solid brass	7/8" O.D.	satin	25	25	13.08 EA
210-084	1 1/2" x 8"	solid brass	7/8" O.D.	unfinished	25	25	11.25 EA
210-086	1 1/2" x 8"	solid brass	7/8" O.D.	satin	25	25	14.42 EA
210-122	1 1/2" x 12"	zinc die cast	7/8" O.D.	unfinished	25	25	12.60 EA
SLIP JOINT CONNECTION							
216-084	1 1/2" x 8"	solid brass	7/8" O.D.	unfinished	25	25	11.67 EA
216-086	1 1/2" x 8"	solid brass	7/8" O.D.	chrome pltd	25	25	14.71 EA



Major Tee™ Brass Condensate Tailpiece

- 1 1/4" tube body – 20 gauge
- Branch is higher than standard tailpieces – keeps drain line high and out of sight
- Improves looks and adds storage space
- Eliminates extra extension tailpiece



Item No.	Dimensions	Tubular Connection	Branch Connection	Finish	Min. Qty.	Case Qty.	List Price
213-067	1 1/4" x 6"	fine thread	3/4" MIP	unfinished	25	25	11.91 EA
213-069	1 1/4" x 6"	fine thread	7/8" O.D.	unfinished	25	25	9.33 EA

Lavatory Branch Tailpiece

- For condensate drain
- 1 1/4" tubular brass body
- 7/8" O.D. copper branch



Item No.	Dimensions	Gauge	Tubular Connection	Finish	Min. Qty.	Case Qty.	List Price
213-060	1 1/4" x 6"	20	fine thread	unfinished	25	25	9.19 EA
213-061	1 1/4" x 6"	20	fine thread x fine thread	unfinished	25	25	10.39 EA
213-068	1 1/4" x 6"	20	fine thread	chrome pltd	25	25	12.24 EA
215-064	1 1/4" x 6"	22	slip joint	unfinished	25	25	10.28 EA
215-066	1 1/4" x 6"	22	slip joint	chrome pltd	25	25	13.19 EA

Brass Sink Tailpiece

Single Flange or Double Flanged

- 22 gauge
- 1 1/2" tube body

Item No.	Dimensions	Finish	Min. Qty.	Case Qty.	List Price
220-040	1 1/2" x 4"	unfinished	50	50	3.19 EA
220-048	1 1/2" x 4"	chrome	48	48	3.52 EA
220-060	1 1/2" x 6"	unfinished	50	50	4.89 EA
220-068	1 1/2" x 6"	chrome	24	24	3.51 EA
220-088	1 1/2" x 8"	chrome	24	24	4.73 EA
220-120	1 1/2" x 12"	unfinished	25	25	6.84 EA
220-128	1 1/2" x 12"	chrome	24	24	6.29 EA
220-168	1 1/2" x 12" – double flange	chrome	24	24	8.67 EA



Brass Threaded Tube – T.B.E.

- 20 gauge
- Fine thread both ends

Item No.	Dimensions	Finish	Min. Qty.	Case Qty.	List Price
223-128	1 1/4" x 12"	satın	24	24	9.60 EA
224-128	1 1/2" x 12"	satın	24	24	11.35 EA



Slip Joint Extension Tube

- 22 gauge brass
- Die cast chrome nut with poly washer

Item No.	Dimensions	Min. Qty.	Case Qty.	List Price
225-068	1 1/4" x 6"	24	24	5.54 EA
225-088	1 1/4" x 8"	24	24	6.06 EA
225-128	1 1/4" x 12"	24	24	8.29 EA
226-068	1 1/2" x 6"	24	24	6.11 EA
226-088	1 1/2" x 8"	24	24	7.39 EA
226-128	1 1/2" x 12"	24	24	10.00 EA



Dishwasher Tailpiece

- One piece polypropylene body with baffle

Item No.	Dimensions	Tubular Connection	Branch Connection	Color	Min. Qty.	Case Qty.	List Price
231-2	1 1/2" x 8"	direct	1/2" hose barb	white	25	25	2.49 EA
231-3	1 1/2" x 8"	direct	3/4" hose barb	white	25	25	2.50 EA
232-2	1 1/2" x 8"	slip joint	1/2" hose barb	white	25	25	2.76 EA
232-3	1 1/2" x 8"	slip joint	3/4" hose barb	white	25	25	2.76 EA
232-3B	1 1/2" x 8"	slip joint	3/4" hose barb	black	25	25	2.76 EA



SUPPLY

DRAINAGE

SUPPORT

TESTING

SPECIALTIES

TOOLS

ACCESS



234-2



234-10



230-160



230-060



236-160



238-160

Traps

S Traps

- 1 1/2" tube body
- Tubular polypropylene
- Tubular wall bend
- Wing nuts

P Traps

- Tubular polypropylene
- Wing nuts for easy installation

Item No.	Size	Description	Color	Min. Qty.	Case Qty.	List Price
S TRAPS						
234-2	1 1/2"	PVC adapter, slip-joint connection	white	25	25	7.37 EA
P TRAPS						
234-5	1 1/4"	1 1/4" wall bend wing type nuts	white	25	25	3.36 EA
234-5B	1 1/4"	1 1/4" wall bend wing type nuts	black	25	25	3.36 EA
234-10	1 1/2"	1 1/2" PVC trap adapter	white	25	25	2.48 EA
234-10B	1 1/2"	1 1/2" ABS trap adapter	black	25	25	2.48 EA

Poly Sink Tailpiece

Single Flange or Double Flanged

- Available in white or black polypropylene

Item No.	Dimensions	Color	Min. Qty.	Case Qty.	List Price
230-040	1 1/2" x 4", flanged one end	white	25	25	0.78 EA
230-040B	1 1/2" x 4", flanged one end	black	25	25	0.73 EA
230-060	1 1/2" x 6", flanged one end	white	25	25	0.73 EA
230-080	1 1/2" x 8", flanged one end	white	25	25	1.01 EA
230-120	1 1/2" x 12", flanged one end	white	25	25	1.62 EA
230-160	1 1/2" x 16" double flanged	white	25	25	2.71 EA
230-160B	1 1/2" x 16" double flanged	black	25	25	2.79 EA

Extension Tube

Slip Joint or Solvent Weld

- White or black polypropylene and PVC models available

Item No.	Dimensions	Connection	Material	Min. Qty.	Case Qty.	List Price
236-060	1 1/2" x 6"	slip joint	white polypro	25	25	1.63 EA
236-080	1 1/2" x 8"	slip joint	white polypro	25	25	1.77 EA
236-120	1 1/2" x 12"	slip joint	white polypro	25	25	2.02 EA
236-160	1 1/2" x 16"	double slip joint	white polypro	25	25	3.55 EA
236-160B	1 1/2" x 16"	double slip joint	black polypro	25	25	3.55 EA
238-120	1 1/2" x 12"	solvent weld	white PVC	25	25	2.57 EA
238-160	1 1/2" x 16"	double solvent weld	white PVC	25	25	3.04 EA

End Outlet Waste

Direct Connect

- Telescopic 12" to 16" with baffle tee
- Available in white or black polypropylene

Universal

- Telescopic 12" to 16" with baffle tee
- Slip joint with two direct connect adapters
- Available in white or black polypropylene

Wye Branch – Direct Connect

- Telescopic 12" to 16" with baffle tee
- 1/2" and 3/4" "Y" branch connection
- Available in white or black polypropylene

Item No.	Color	"Y" Size	Min. Qty.	Case Qty.	List Price
DIRECT CONNECT					
253-550	white	–	25	25	5.50 EA
253-550B	black	–	25	25	5.46 EA
UNIVERSAL					
257-550	white	–	25	25	6.55 EA
257-550B	black	–	25	25	6.48 EA
WYE BRANCH - DIRECT CONNECT					
253-552	white	1/2"	15	15	7.08 EA
253-552B	black	1/2"	15	15	7.07 EA
253-553	white	3/4"	15	15	7.08 EA

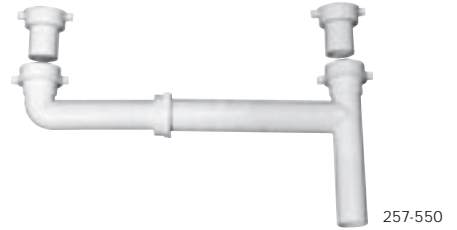

Center Outlet Waste

Universal

- 16" baffle tee
- Slip joint with two direct connect adapters
- White polypropylene

Item No.	Description	Min. Qty.	Case Qty.	List Price
258-160	Universal center outlet waste	25	25	7.07 EA



Disposal Waste Kit

End Outlet

- Telescopic with baffle tee and 6" sink tailpiece
- Complete with disposal connection washer for clamping ring type disposers
- Available in white or black polypropylene

Item No.	Description	Color	Min. Qty.	Case Qty.	List Price
251-550	Disposal waste kit	white	25	25	6.76 EA
251-550B	Disposal waste kit	black	25	25	6.92 EA



SUPPLY

DRAINAGE

SUPPORT

TESTING

SPECIALTIES

TOOLS

ACCESS

Slip Nut

- Slip nuts available in rough and chrome plated brass, chrome plated die cast, and white polypropylene



980-5



985-5



988-6

Item No.	Size	Material	Finish	Min. Qty.	Case Qty.	List Price
980-5	1 1/4" x 1 1/4"	solid brass	chrome plated	100	100	1.68 EA
980-6	1 1/2" x 1 1/2"	solid brass	chrome plated	100	100	1.95 EA
980-8	1 1/2" x 1 1/4"	solid brass	chrome plated	100	100	1.96 EA
981-5	1 1/4" x 1 1/4"	solid brass	rough brass	100	100	1.62 EA
981-6	1 1/2" x 1 1/2"	solid brass	rough brass	100	100	1.64 EA
985-5	1 1/4" x 1 1/4"	zinc	chrome plated	100	100	0.63 EA
985-6	1 1/2" x 1 1/2"	zinc	chrome plated	100	100	0.89 EA
985-8	1 1/2" x 1 1/4"	zinc	chrome plated	100	100	1.23 EA
986-6	1 1/2" x 1 1/2"	zinc	brass plated	100	100	0.63 EA
988-6	1 1/2" x 1 1/2"	polypro	white	100	100	0.36 EA

Two-Piece Slip Nut

- Replaces fractured or stripped, metal or plastic, slip nuts without disassembly
- Perfect for problems on soldered trap arms, bath wastes and captured nuts on sink traps. Includes washer



Item No.	Size	Material	Color	Min. Qty.	Case Qty.	List Price
290-20379	1 1/2" x 1 1/2"	poly	white	25	25	2.95 EA

Tailpiece & Slip Washer

C.I. Rubber, Rubber and Polyethylene



990-6



995-6



990-7



996-6



991-6

Item No.	Description	Material	Min. Qty.	Case Qty.	List Price
BULK					
990-6	1 1/2" flat tailpiece washer	rubber	100	1000	0.36 EA
990-7	1 1/2" cloth-inserted tailpiece washer	C.I. rubber	100	1000	0.41 EA
991-6	1 1/2" flanged tailpiece washer	poly	100	1000	0.12 EA
995-5	1 1/4" x 1 1/4" slip washer	rubber	100	1000	0.16 EA
995-6	1 1/2" x 1 1/2" slip washer	rubber	100	1000	0.16 EA
995-8	1 1/2" x 1 1/4" slip washer	rubber	100	1000	0.21 EA
996-6	1 1/2" x 1 1/2" slip washer, beveled	poly	100	1000	0.9 EA
996-8	1 1/2" x 1 1/4" slip washer, beveled	poly	100	1000	0.13 EA
JOB PACK					
990-20385	1 1/2" cloth-inserted tailpiece washer	C.I. rubber	25	300	0.42 EA
995-20320	1 1/4" square-cut slip washer	rubber	25	200	0.35 EA
995-20330	1 1/2" square-cut slip washer	rubber	25	200	0.36 EA
995-20335	1 1/2" x 1 1/4" square-cut slip washer	rubber	25	200	0.35 EA
995-20340	2" square-cut slip washer	rubber	25	200	0.35 EA

Drip-Free™ Slip Joint Washer

- Tighten by hand—no leaks

Combo Washer

- Tighten by hand—no leaks

Tailpiece Washer

- Perfect washer for basket strainer installations
- Tighten by hand—no leaks



Item No.	Description	Material	Color	Min. Qty.	Case Qty.	List Price
SLIP JOINT WASHERS						
290-20300	1 ¼" washer	soft PVC	white	25	300	0.48 EA
290-20301	1 ¼" washer	soft PVC	white	100	1000	0.44 EA
290-20310	1 ½" washer	soft PVC	black	25	300	0.48 EA
290-20311	1 ½" washer	soft PVC	black	100	1000	0.44 EA
COMBO WASHERS						
290-20312	1 ½" × 1 ¼" reducing slip joint washer	thermoplastic rubber	—	10	100	0.61 EA
290-20313	1 ½" × 1 ¼" reducing slip joint washer	thermoplastic rubber	—	50	500	0.54 EA
TAILPIECE WASHERS						
290-20380	1 ½" washer	urethane	—	25	300	0.48 EA
290-20381	1 ½" washer	urethane	—	100	1000	0.44 EA

No-Putty Gasket™

- Replaces plumbers putty, won't dry out, stain or smudge, no mess
- Creates a tight seal on all finishes and materials
- Fits all standard drain attachments
- Stands up to the toughest commercial cleaners
- Allows you to pre-fab fixtures

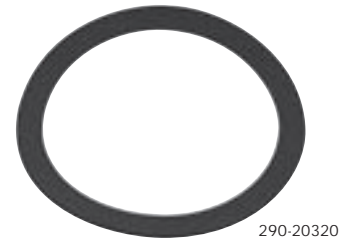

Item No.	Description	Min. Qty.	Case Qty.	List Price
BULK				
290-20320	4 ¼" O.D. × 3 ¾" I.D. gasket for kitchen basket strainer	100	1000	0.60 EA
290-20322	2" O.D. × 1 ½" I.D. gasket for lavatory drain, kitchen spray hose guide	100	1000	0.60 EA
290-20324	2 ¾" O.D. × 2" I.D. gasket for laundry sink, bar sink, tub drain	100	1000	0.60 EA
BAR-CODED BAGS IN A CUT-CASE BOX				
290-20320PK2	4 ¼" O.D. × 3 ¾" I.D. gasket for kitchen basket strainer 4/bag, 12 bags/box	1	12	2.70 EA
290-20324PK2	2 ¾" O.D. × 2" I.D. gasket for laundry sink, bar sink, tub drain, 4/bag, 12 bags/box	1	12	2.70 EA
BAR-CODED BAGS IN A BAR-CODED DISPENSER BOX				
290-20320PK4	4 ¼" O.D. × 3 ¾" I.D. gasket for kitchen basket strainer, 4/bag, 20 bags/box	1	1	63.97 BX
290-20322PK4	2" O.D. × 1 ½" I.D. gasket for lavatory drain, kitchen spray hose guide 4/bag, 50 bags/box	1	1	128.38 BX
290-20324PK4	2 ¾" O.D. × 2" I.D. gasket for laundry sink, bar sink, tub drain, 4/bag, 50 bags/box	1	1	128.38 BX



Roll gasket to remove backing paper.





Brass DWV Connector

DeSanko Fitting

- Solid brass body and nut
- Male and female styles

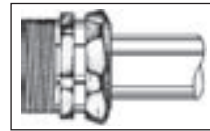

Connects tubular pipe to drainage pipe.

Item No.	Description	Min. Qty.	Case Qty.	List Price
270-6	1 1/2" tube x 1 1/2" MIP connection –with brass ferrule	25	25	10.84 EA
272-6	1 1/2" tube x 1 1/2" FIP connection –with brass ferrule	25	25	11.26 EA

DWV Slip Joint Adapter

Brass Marvel Thread

- Sweat on to copper DWV pipe to make slip joint connections

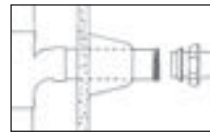

Slip joint thread for copper DWV pipe

Item No.	Description	Min. Qty.	Case Qty.	List Price
274-5	1 1/4" female sweat x 1 1/4" slip joint thread	10	100	7.81 EA
274-6	1 1/2" female sweat x 1 1/2" slip joint thread	10	100	5.67 EA
274-7	2" female sweat x 2" slip joint thread	10	100	5.73 EA

Industrial Sink Plug

- All brass industrial sink plug complete as shown with 1" tailpiece and brass stopper

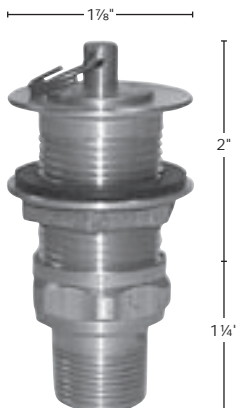

Item No.	Description	Min. Qty.	Case Qty.	List Price
INDIVIDUALLY BAR-CODED				
290-20200	Brass sink plug with 1" tailpiece and brass stopper	1	10	17.49 EA
BULK				
290-20202	Brass locknut for 290-20200	5	25	3.72 EA

Lavatory Drain

- Model 290-20514 comes standard with brass nut and grid strainer



strainer pattern

Item No.	Description	Min. Qty.	Case Qty.	List Price
INDIVIDUALLY BAR-CODED				
290-20514	8" brass with grid strainer and brass lock nut	1	12	19.55 EA



Basin Strainer

- Three prong push in style
- Nickel plated

Item No.	Description	Min. Qty.	Case Qty.	List Price
290-20525	1 5/8" three prong	3	120	1.19 EA
290-20526	1 7/8" three prong	3	120	1.45 EA

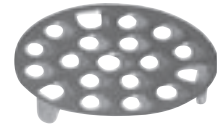

Basin Gasket

- Black rubber, Mack pattern

Item No.	Description	Min. Qty.	Case Qty.	List Price
290-20560	1 1/4"	5	25	0.74 EA
290-20562	1 1/4" wide flange	5	25	0.72 EA
290-20564	1 5/16"	5	25	1.18 EA
290-20566	1 3/8"	5	25	0.74 EA
290-20568	1 1/2"	5	25	0.75 EA



Tub Overflow Gasket

- Molded sponge

Item No.	Description	Min. Qty.	Case Qty.	List Price
974-60116	Molded tub overflow gasket	12	120	0.87 EA



SUPPLY

DRAINAGE

SUPPORT

TESTING

SPECIALTIES

TOOLS

ACCESS



901-10



901-12

Hose Clamp

Stainless Steel

- 300 series stainless steel band and housing
- 1/2" wide x .025 thick steel band for strength
Finished edges prevent hose damage
- 410 zinc plated screw tightens with
screwdriver, nutdriver, wrench or socket

Item No.	Description	Min. Qty.	Case Qty.	List Price
901-10	9/16" min. – 1 1/8" max.	10	100	0.85 EA
901-12	1 1/16" min. – 1 1/4" max.	10	100	0.93 EA
901-16	1 3/16" min. – 1 1/2" max.	10	100	0.97 EA
901-20	1 3/8" min. – 1 3/4" max.	10	100	0.94 EA
901-24	1 1/2" min. – 2" max.	10	100	0.99 EA
901-28	1 5/8" min. – 2 1/4" max.	10	100	0.98 EA
901-32	1 3/4" min. – 2 1/2" max.	10	100	1.07 EA



Anti-Siphon Auto Vent

- Air automatically enters drain line for proper venting, then the spring-loaded seal closes after drainage to prevent escape of sewer gases
- For secondary venting only. Each drainage system must have a main vent stack
- To be installed in a readily accessible location with free flow of air, never in a sealed wall cavity

Item No.	Description	Min. Qty.	Case Qty.	List Price
BULK				
239	1 1/2" MIP vent, ABS	50	50	3.98 EA
BAR-CODED BAGS IN A CUT CASE BOX				
239PK2	1 1/2" MIP vent, ABS, 1/bag	10	10	4.55 BG



Dishwasher Air Gap

- Heavy duty model has a solid brass chrome cap
- Economy model has a chrome plated plastic cap
- Inlet 1/2" hose barb; outlet 3/4" hose barb
- Molded polypropylene body, full 3/8" passageway
- Spitting action eliminated with design of inlet tube and inner cap



249



249-20135



Item No.	Description	Min. Qty.	Case Qty.	List Price
249	Heavy duty air gap with chrome plated brass cap	25	25	8.92 EA
INDIVIDUALLY BAR-CODED				
249-20135	Economy air gap with chrome plated poly cap	1	10	4.75 EA

Disposal Parts

Item No.	Description	Min. Qty.	Case Qty.	List Price
BAGGED				
290-20180	Replacement In-Sink-Erator*, drain ell gasket	5	25	0.75 EA
INDIVIDUALLY BAR-CODED				
290-20181	Replacement fit-all, splash guard – black rubber	1	25	1.88 EA
290-20185	7" long poly disposal elbow	1	12	3.05 EA

* Not made by original manufacturer, but manufactured to same specifications as original part.

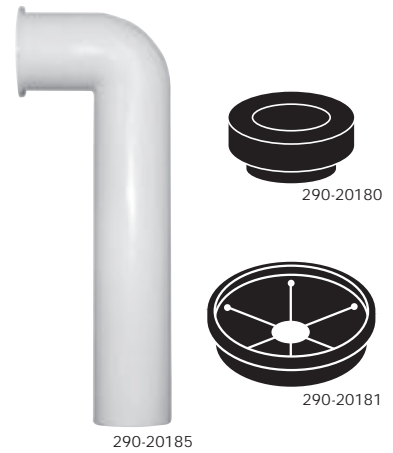

Drain Connector Kit

for Dishwasher

Item No.	Description	Min. Qty.	Case Qty.	List Price
901	Black elastomer adapter only – bulk pack	100	100	0.80 EA
902	Black elastomer adapter with 100% stainless steel hose clamps – slotted/hex screws	50	50	2.35 EA

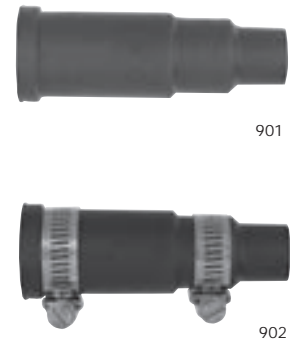

Dishwasher Drain Hose

- EPDM tube has double-ply, polyester spiral reinforcement to make it durable and kink resistant
- 5/8" connects dishwasher pump to air gap inlet or directly to our Long Branch tailpiece, or to a disposer tap-in (with a connector kit)
- 7/8" connects the air gap outlet to branch tailpiece or disposer tap-in
- Meets AHAM requirements



Related Products
Long Branch p 247

Item No.	Description	Min. Qty.	Case Qty.	List Price
INDIVIDUALLY BAR-CODED				
905	5/8" I.D. x 50 ft. coil drain hose	1	1	43.88 EA
906	7/8" I.D. x 50 ft. coil drain hose	1	1	61.15 EA



Specifications

	Burst Rating	
	7/8"	5/8"
	260 PSI	280 PSI
Safe Working Pressure 100°F	50 PSI	50 PSI



420



425



420-PBJ

Plumb Perfect™ Closet Bolt

Patent Nos: 217,458; 249,227; 255,647

- Tensile strength exceeds 1,100 lbs. per bolt
- Redesigned threads provide increased strength and smoother, faster threading
- 100% corrosion proof bolts are now available in convenient 2" and 3½" lengths in addition to standard 2½"
- Improved adaptability—open end nut now fits ½" sockets, and fits under most bolt caps. Bolt base loads into any flange

Dome Nut Installation



Combination nut and cap. Appliance white. Cannot be knocked off.



Cut off excess bolt, leave 3 to 4 threads above china.



Install nut and completely hand tighten.



Tighten nut. (1 to 2 full turns)

Open Nut Installation



For use with bolt caps. Fits ½" sockets.



Install over cap washer and hand tighten.

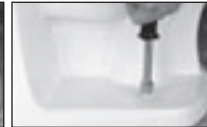

Tighten nut. (1 to 2 full turns)



Cut off excess bolt. Snap-on bolt cap.

Item No.	Description	Min. Qty.	Case Qty.	List Price
DOME NUT				
BULK				
420	2½" bolt, bulk box	100	100	0.50 EA
420-PB	2½" bolt, 2/bag	50	50	1.12 BG
421	2" bolt, bulk box	100	100	0.50 EA
421-PB	2" bolt, 2/bag	50	50	1.06 BG
422	3½" bolt, bulk box	100	100	0.62 EA
422-PB	3½" bolt, 2/bag	50	50	1.36 BG
BAR-CODED BAGS IN A BAR-CODED DISPENSER BOX				
420-PBJ	2½" bolt, 2/bag, 50 bags/box	1	1	61.00 BX
421-PBJ	2" bolt, 2/bag, 50 bags/box	1	1	56.65 BX
422-PBJ	3½" bolt, 2/bag, 50 bags/box	1	1	71.64 BX
OPEN NUT				
BULK				
425	2½" bolt, bulk box	100	100	0.46 EA
425-PB	2½" bolt, 2/bag	25	250	0.98 BG
426	2" bolt, bulk box	100	100	0.36 EA
426-PB	2" bolt, 2/bag	50	50	0.91 BG
427	3½" bolt, bulk box	100	100	0.54 EA
427-PB	3½" bolt, 2/bag	50	50	1.19 BG
BAR-CODED BAGS IN A BAR-CODED DISPENSER BOX				
425-PBJ	2½" bolt, 2/bag, 50 bags/box	1	1	50.50 BX
426-PBJ	2" bolt, 2/bag, 50 bags/box	1	1	51.10 BX
427-PBJ	3½" bolt, 2/bag, 50 bags/box	1	1	65.14 BX
BAR-CODED BAGS IN A CUT CASE BOX				
420-PBPK2	2½" bolt, 2/bag	10	10	1.29 BG
422-PBPK2	3½" bolt, 2/bag	10	10	1.47 EA
425-PBPK2	2½" bolt, 2/bag	10	10	1.22 BG
427-PBPK2	3½" bolt, 2/bag	10	10	1.38 EA

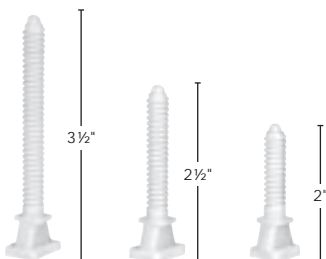

Solid Brass Closet Bolt

- Brass bolts with nickel plated steel nut and zinc plated washer
- Nuts and washers available separately

Item No.	Description	Min. Qty.	Case Qty.	List Price
SOLID BRASS CLOSET BOLT				
BULK				
410	¼" × 20–2¼" bolt with nut & washer, bulk box	100	1000	0.78 EA
410-PB	¼" × 20–2¼" bolt with nut & washer, 2/bag	50	500	1.45 BG
411	¼" × 20–3½" bolt with nut & washer, bulk box	100	500	1.01 EA
411-PB	¼" × 20–3½" bolt with nut & washer, 2/bag	50	250	2.01 BG
415	⅝" × 18–1¾" bolt with nut & washer, bulk box	100	500	1.00 EA
415-PB	⅝" × 18–1¾" bolt with nut & washer, 2/bag	50	250	1.89 BG
416	⅝" × 18–2¼" bolt with nut & washer, bulk box	100	500	1.12 EA
416-PB	⅝" × 18–2¼" bolt with nut & washer, 2/bag	50	250	2.34 BG
BAR-CODED BAGS IN A CUT CASE BOX				
416PK2	⅝" × 18–2¼" bolt with nut & washer, 2/bag	25	25	2.46 EA
COMPONENTS				
BULK				
417	¼" × 20, 7/16" hex, nickel plated steel open end nut	100	1000	0.13 EA
418	⅝" × 18, 9/16" hex, nickel plated steel open end nut	100	1000	0.22 EA
419	Closet washer – zinc plated steel (.042 thick)	100	1000	0.12 EA
490-11223	¼" × 20, 7/16" hex, nickel plated brass open end nut	25	250	0.48 EA
490-11227	⅝" × 18, 9/16" hex, nickel plated brass open end nut	25	250	0.50 EA
490-11221	Closet washer – nickel plated brass	25	2500	0.34 EA



416



417



419

Snap-It™ Brass Closet Bolt

- Nickel plated steel nut and zinc plated washers

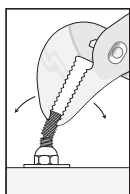

Snap off tip with pliers after installation.

Item No.	Description	Min. Qty.	Case Qty.	List Price
INDIVIDUALLY BAR-CODED BAG				
412-PB	¼" × 20–2¼" bolt with nut & washers, 2/bag	50	250	1.80 BG
414-PB	⅝" × 18–2¼" bolt with nut & washers, 2/bag	50	250	2.59 BG
BAR-CODED BAGS IN A CUT CASE BOX				
412-PBPK2	¼" × 20–2¼" bolt with nut & washers, 2/bag	25	25	1.91 BG

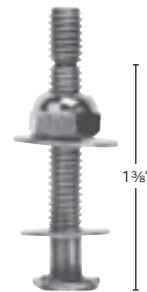

Closet Bolt Cover Cap

- Available in white or bone

Item No.	Description	Min. Qty.	Case Qty.	List Price
INDIVIDUALLY BAR-CODED BAG				
490-11240	White cap & snap-on washer, 2/bag	1	50	1.33 BG
490-11242	Bone cap & snap-on washer, 2/bag	1	50	1.33 BG



490-11240

Available Spring 2007



NEW Smart Cap™
Closet Bolt Cover Cap

Patent pending

- Taller cap eliminates the need to cut brass bolts.
- Base creates a tight seal that helps provide a continuous sanitary seal between base and china
- Great for new installations and can be installed on existing toilets



Never cut brass bolts again. Bolts that are cut become too short to reuse when additional flooring is added.



Base is installed between the bowl and nut.



Cap screws onto base for a secure connection.

Item No.	Description	Min. Qty.	Case Qty.	List Price
BULK				
440-2W	Cover cap w/ 425-PB closet bolts, white, 2/bag	1	25	2.60 EA
442-2W	Cover cap, white, 2/bag	1	25	1.65 EA
INDIVIDUALLY BAR-CODED BAG				
440-2WPK	Cover cap w/ 425-PB closet bolts, white, 2/bag	10	10	2.75 EA
442-2WPK	Cover cap, white, 2/bag	1	1	2.00 EA

Tank Bolt Set

- Cloth inserted washers
- 7/8" truss head with deep slot



452-PB



490-10500



490-10502

Item No.	Description	Min. Qty.	Case Qty.	List Price
BULK				
452-PB	Solid brass bolts with 2 ³ / ₃₂ " head and hex nuts; plated washers and wing nut; cloth inserted washers, 2/bag	50	50	3.60 BG
490-10502	Cloth inserted washer for tank bolt	25	250	0.32 EA
490-10505	Brass hex nut for 490-10500	25	200	0.18 EA
INDIVIDUALLY BAR-CODED BAG				
490-10500	Solid brass bolts with 7/8" head and hex nuts; brass washers and cloth inserted washers, 2/bag	1	50	4.86 BG

Tank Bowl Kits

Universal

- 3/4" high universal sponge gasket with deluxe tank-to-bowl bolts

American Standard*

- 1 1/8" high recessed gasket with deluxe brass tank-to-bowl bolts

Gerber*

- 1 3/16" high gasket with deluxe brass tank-to-bowl bolts

Kohler*

- 3/4" high molded rubber gasket with 3 deluxe brass tank-to-bowl bolts
- 3/4" high sponge gasket with deluxe brass tank-to-bowl bolts

Eljer*

- 7/16" high gasket with deluxe brass tank-to-bowl bolts

Mansfield*

- Sponge gasket with 3 deluxe solid brass tank-to-bowl bolts
- Also used for American Standard* gasket (our 490-10660)



490-10555



490-10560



490-10565

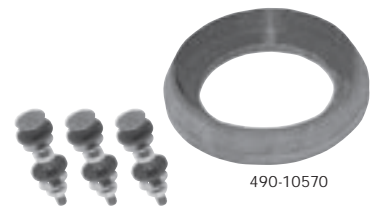

490-10570

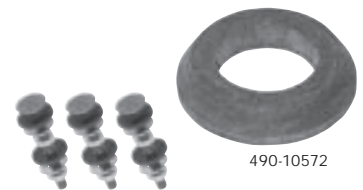

490-10572



490-10575



490-10585

Item No.	Description	Min. Qty.	Case Qty.	List Price
INDIVIDUALLY BAR-CODED BULK				
UNIVERSAL				
490-10555	3/4" high universal tank bowl kit	1	25	6.48 KT
AMERICAN STANDARD*				
490-10560	1 1/8" high tank bowl kit	1	25	6.39 KT
GERBER*				
490-10565	1 3/16" high tank bowl kit	1	25	7.36 KT
KOHLER*				
490-10570	3/4" high tank bowl kit	1	25	10.03 KT
490-10572	Tank bowl kit with "sponge" gasket	1	25	9.29 KT
ELJER*				
490-10575	7/16" high tank bowl kit	1	25	6.76 KT
MANSFIELD*				
490-10585	Tank bowl kit with 3 tank bolts and sponge gasket	1	25	8.53 KT

* Indicates the part was not made by original manufacturer, but manufactured to the same specifications as original part.

SUPPLY

DRAINAGE

SUPPORT

TESTING

SPECIALTIES

TOOLS

ACCESS



490-10655



490-10660



490-10665

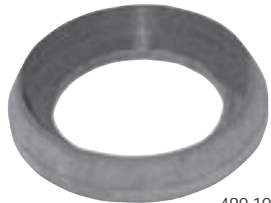

490-10670



490-10672



490-10675

Tank-to-Bowl Gaskets

Universal

- 3⁵/₈" O.D. × 2¹/₄" I.D. × ³/₄" high

American Standard*/Mansfield*

- 3¹/₂" O.D. × 2¹/₈" I.D. × 1¹/₈" high

Gerber*

- 3¹/₄" O.D. × 2¹/₈" I.D. × 1³/₁₆" high

Kohler*

- Molded rubber: 3³/₄" O.D. × 2¹/₂" I.D. × ³/₄" high
- Sponge: 3¹/₄" O.D. × 2" I.D. × ³/₄" high

Eljer*

- 3³/₈" O.D. × 2¹/₄" I.D. × ⁷/₁₆" high

Item No.	Description	Material	Min. Qty.	Case Qty.	List Price
UNIVERSAL					
BULK					
490-10656	³ / ₄ " high gasket	molded rubber	25	25	1.51 EA
INDIVIDUALLY BAR-CODED BULK					
490-10655	³ / ₄ " high gasket	molded rubber	1	20	1.88 EA
AMERICAN STANDARD*/MANSFIELD*					
BULK					
490-10661	1 ¹ / ₈ " high gasket	sponge	25	25	1.37 EA
INDIVIDUALLY BAR-CODED BULK					
490-10660	1 ¹ / ₈ " high gasket	sponge	1	20	1.89 EA
GERBER*					
BULK					
490-10666	1 ³ / ₁₆ " high gasket	sponge	25	25	2.30 EA
INDIVIDUALLY BAR-CODED BULK					
490-10665	1 ³ / ₁₆ " high gasket	sponge	1	20	2.76 EA
KOHLER*					
BULK					
490-10671	³ / ₄ " high gasket	molded rubber	25	25	2.98 EA
490-10673	³ / ₄ " high gasket	sponge	25	25	1.93 EA
INDIVIDUALLY BAR-CODED BULK					
490-10670	³ / ₄ " high gasket	molded rubber	1	20	3.35 EA
490-10672	³ / ₄ " high gasket	sponge	1	20	2.70 EA
ELJER*					
BULK					
490-10676	⁷ / ₁₆ " high gasket	molded rubber	25	25	1.98 EA
INDIVIDUALLY BAR-CODED BULK					
490-10675	⁷ / ₁₆ " high gasket	molded rubber	1	20	2.62 EA

* Indicates the part was not made by original manufacturer, but manufactured to the same specifications as original part.

Spud Gasket

- Installs on flush valve spud
- Seals brass spud to china



Item No.	Description	Min. Qty.	Case Qty.	List Price
490-11520	1 1/4" urinal spud gasket	5	25	1.54 EA
490-11522	1 1/2" closet spud gasket	5	25	1.28 EA
490-11530	1" x 3/4" closet spud gasket	5	25	1.10 EA

Closet Bowl Cushion

- Sponge rubber – ring type or wide flange
- Bowl setting alternative to wax

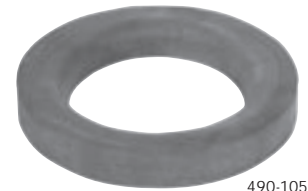

490-10540



490-10545

Item No.	Description	Min. Qty.	Case Qty.	List Price
SPONGE RUBBER - RING TYPE				
490-10540	5 3/8" O.D. x 3 3/8" I.D. x 9/16" high	10	10	3.77 EA
490-10541	5 3/8" O.D. x 3 1/2" I.D. x 9/16" high	10	10	3.37 EA
490-10542	5 3/8" O.D. x 3 1/2" I.D. x 3/4" high	10	10	3.47 EA
490-10543	5 3/8" O.D. x 3 1/2" I.D. x 1" high	10	10	4.10 EA
SPONGE RUBBER - WIDE FLANGE				
490-10545	6 3/4" O.D. x 3 1/2" I.D. x 3/8" high	10	10	3.63 EA
490-10546	6 3/4" O.D. x 3 1/2" I.D. x 9/16" high	10	10	4.30 EA
490-10547	6 3/4" O.D. x 3 1/2" I.D. x 3/4" high	10	10	4.95 EA
490-10548	6 3/4" O.D. x 3 1/2" I.D. x 1" high	10	10	6.30 EA

American Standard* Actuating Unit

Item No.	Description	Min. Qty.	Case Qty.	List Price
INDIVIDUALLY BAR-CODED BULK				
490-11164	#33642.07* #5 actuating unit	1	6	8.93 EA
490-11166	#8162.07* #4 actuating unit – with legs	1	6	10.47 EA
490-11168	#73880.07* #6 actuating unit	1	6	8.74 EA
490-11170	#33582.07* #4 actuating unit – water saver	1	6	13.05 EA
490-11172	#47089.07* flush valve #5 – replacement	1	6	22.60 EA

* Indicates the part was not made by original manufacturer, but manufactured to the same specifications as original part.



490-11166

490-11172

Plastic Flush Valve

- Complete replacement plastic flush valve with flapper
- White body with clear vinyl chemical resistant flapper
- Includes 23-link stainless steel chain



Item No.	Description	Min. Qty.	Case Qty.	List Price
INDIVIDUALLY BAR-CODED BULK				
490-11150	8" flush valve with chemical resistant flapper	1	12	7.06 EA
490-11151	10 5/8" flush valve with chemical resistant flapper	1	12	7.76 EA
BULK				
490-11152	Gasket only for 490-11150	5	25	1.88 EA

American Standard Flush Valve Disc

Without Helmet

- Genuine American Standard - snap-on or screw-on

With Helmet*

- Snap-on or screw-on



490-10302



490-10312



490-10305



490-10315

Item No.	Description	Attachment Method	Min. Qty.	Case Qty.	List Price
WITHOUT HELMET					
BULK					
490-10303	A. S. #33643-07	snap-on	50	50	2.70 EA
490-10313	A. S. #73383-07	screw-on	50	50	2.72 EA
INDIVIDUALLY BAR-CODED					
490-10302	A. S. #33643-07	snap-on	1	25	2.97 EA
490-10312	A. S. #73383-07	screw-on	1	25	3.11 EA
WITH HELMET					
BULK					
490-10306	Flush valve disc*	snap-on	25	25	1.69 EA
490-10316	Flush valve disc*	screw-on	25	25	2.15 EA
INDIVIDUALLY BAR-CODED					
490-10305	Flush valve disc*	snap-on	1	25	1.96 EA
490-10315	Flush valve disc*	screw-on	1	25	2.66 EA

* Indicates the part was not made by original manufacturer, but manufactured to the same specifications as original part.

American Standard* Flush Valve Seal

- For American Standard* (N-3055)



Item No.	Description	Min. Qty.	Case Qty.	List Price
INDIVIDUALLY BAR-CODED BULK				
490-10320	Flush valve replacement seal	1	25	2.79 EA

* Indicates the part was not made by original manufacturer, but manufactured to the same specifications as original part.

Mansfield Flush Valve Gasket

- Genuine Mansfield, old style and new style



490-10340



490-10341

Item No.	Description	Min. Qty.	Case Qty.	List Price
INDIVIDUALLY BAR-CODED BULK				
490-10340	Mansfield gasket – old style	1	25	3.49 EA
490-10341	Mansfield gasket – new style	1	25	1.81 EA

Flappers

Eljer "Low Boy" Flapper

- Genuine Eljer flapper for Patrician, Windsor, and Canterbury Aqualine low-boy closets

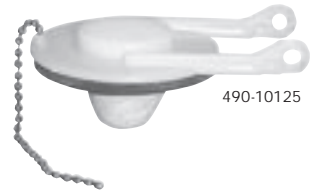

Chemical Resistant Flapper

- Clear, medical grade vinyl, resists warping

3-way Flapper

- Clear, medical grade vinyl, chemical resistant

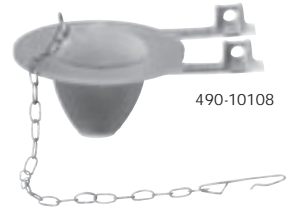

Kohler* Round Flapper

Replacement Flapper - New Style

- Fits: Kohler*, American Standard*, and Coast*
- Thermal Plastic Rubber (TPR) seal
- 1.6 GPF with handle chain



Universal Flapper

- Works on plastic and brass flush valves
- Removable trunion

Item No.	Description	Min. Qty.	Case Qty.	List Price
ELJER "LOW BOY"				
BULK				
490-10126	Plastic flapper with styrofoam cone	25	25	3.44 EA
INDIVIDUALLY BAR-CODED BULK				
490-10125	Plastic flapper with styrofoam cone	1	20	4.23 EA
CHEMICAL RESISTANT				
BULK				
490-10109	Clear vinyl flapper with 9" s.s. chain and hook	50	50	3.20 EA
INDIVIDUALLY BAR-CODED BULK				
490-10108	Clear vinyl flapper with 9" s.s. chain and hook	1	25	3.62 EA
490-10112	Flapper with 9" chain. 1.6 GPF with 4 orifices	1	25	6.28 EA
3-WAY				
BULK				
490-10111	Clear vinyl flapper with 9" s.s. chain and hook	50	50	3.34 EA
INDIVIDUALLY BAR-CODED BULK				
490-10110	Clear vinyl flapper with 9" s.s. chain and hook	1	25	3.82 EA
KOHLER* ROUND				
BULK				
490-10116	Rubber flapper with 8" s.s. chain and hook	25	25	4.53 EA
INDIVIDUALLY BAR-CODED BULK				
490-10115	Rubber flapper with 8" s.s. chain and hook	1	25	5.04 EA
REPLACEMENT - NEW STYLE				
INDIVIDUALLY BAR-CODED BULK				
490-10120	TPR seal - new style	1	25	5.98 EA
490-10121	TPR seal - 1.6 GPF	1	25	6.94 EA
490-10122	TPR seal only	1	50	1.58 EA
UNIVERSAL				
BULK				
490-10106	Flapper with 9" s.s. chain and hook	25	25	2.52 EA
INDIVIDUALLY BAR-CODED BULK				
490-10105	Flapper with 9" s.s. chain and hook	1	25	2.82 EA

* Indicates the part was not made by original manufacturer, but manufactured to the same specifications as original part.

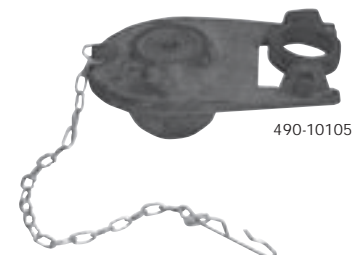

SUPPLY

DRAINAGE

SUPPORT

TESTING

SPECIALTIES

TOOLS

ACCESS



490-10200



490-10210

Flush Valve Balls

Douglas*

Eljer*

Item No.	Description	Min. Qty.	Case Qty.	List Price
DOUGLAS*				
BULK				
490-10201	2½" flush valve tank ball	50	50	2.72 EA
490-10206	3" flush valve tank ball	25	25	4.18 EA
INDIVIDUALLY BAR-CODED BAG				
490-10200	2½" flush valve tank ball, 1/bag	1	25	3.14 BG
490-10205	3" flush valve tank ball, 1/bag	1	20	4.59 BG
ELJER*				
BULK				
490-10211	Flush valve tank ball	50	50	3.04 EA
INDIVIDUALLY BAR-CODED BAG				
490-10210	Flush valve tank ball, 1/bag	1	25	3.27 BG

* Indicates the part was not made by original manufacturer, but manufactured to the same specifications as original part.

Sloan* Vacuum Breaker

- 3 piece vacuum breaker kit

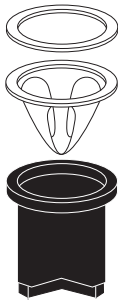

Item No.	Description	Min. Qty.	Case Qty.	List Price
INDIVIDUALLY BAR-CODED KIT				
490-10700	Vacuum breaker kit	1	12	3.06 KT

* Indicates the part was not made by original manufacturer, but manufactured to the same specifications as original part.

Eljer* Touch-flush Tank Ball & Handle Set

- Clip style handle lock



Item No.	Description	Min. Qty.	Case Qty.	List Price
INDIVIDUALLY BAR-CODED BULK				
490-10325	Flush valve tank ball & handle set	1	12	9.36 EA

* Indicates the part was not made by original manufacturer, but manufactured to the same specifications as original part.

SUPPLY

DRAINAGE

SUPPORT

TESTING

SPECIALTIES

TOOLS

ACCESS

Tank Handles

Metal Tank Handle with 8" Brass Arm

American Standard*/Eljer*

American Standard* Neo Angle Mount

- 45° arm for Cadet II series

Kohler* Neo Angle Mount

- For Wellworth II series

Eljer* Side Mount

- New Emblem series

Mansfield ABS

- Non-bendable arm for water saver flush valve



490-11100



490-11120



490-11130



490-11157



490-11155



490-11159



490-11140

Item No.	Description	Min. Qty.	Case Qty.	List Price
METAL HANDLE W/ 8" BRASS ARM				
BULK				
490-11101	Chrome metal handle, die cast nut, & cushion washer	50	50	3.22 EA
INDIVIDUALLY BAR-CODED BULK				
490-11100	Chrome metal handle, die cast nut, & cushion washer, 1/bag	1	25	3.49 BG
490-11120	Chrome metal handle, brass nut, & cushion washer, 1/bag	1	15	6.30 BG
AMERICAN STANDARD*/ELJER*				
INDIVIDUALLY BAR-CODED BULK				
490-11130	Chrome plated ABS tank handle with 4" arm, 1/bag	1	12	4.38 BG
AMERICAN STANDARD* NEO MOUNT				
INDIVIDUALLY BAR-CODED BULK				
490-11157	Chrome plated ABS, 1/bag	1	12	6.86 BG
KOHLER* NEO ANGLE MOUNT				
INDIVIDUALLY BAR-CODED BULK				
490-11155	Chrome plated die-cast with ABS arm, 1/bag	1	12	14.16 BG
ELJER* SIDE MOUNT				
INDIVIDUALLY BAR-CODED BULK				
490-11159	Chrome plated die cast with brass arm	1	12	11.98 EA
MANSFIELD ABS				
INDIVIDUALLY BAR-CODED BULK				
490-11140	Chrome plated ABS	1	12	4.95 EA

* Indicates the part was not made by original manufacturer, but manufactured to the same specifications as original part.

SUPPLY



DRAINAGE

SUPPORT



TESTING



SPECIALTIES

TOOLS

ACCESS



Brass Tank Ball Wire

- 4 1/2" or 5 1/2" lower wire and 10" upper wire available

Item No.	Description	Min. Qty.	Case Qty.	List Price
490-10411	10" brass upper wire, bulk	25	100	0.93 EA
490-10413	4 1/2" brass lower wire, bulk	25	1000	0.42 EA
490-10415	5 1/2" brass lower wire, bulk	25	200	0.65 EA

Float Ball Rod

- Solid Brass

Item No.	Description	Min. Qty.	Case Qty.	List Price
490-10423	10" x 1/4" x 20 thread	25	100	1.60 EA

Poly Tank Float Ball

- High buoyancy polyethylene float ball 1/4" x 20 female thread

Item No.	Description	Min. Qty.	Case Qty.	List Price
490-10451	Black polyethylene	24	24	1.20 EA

Anti-Siphon Ballcock

- 10" anti-siphon ballcock
- Coupling and locknut
- Synthetic washer and vinyl refill tube
- 8" brass float rod

Item No.	Description	Min. Qty.	Case Qty.	List Price
INDIVIDUALLY BAR-CODED BULK				
490-10465	10" anti-siphon ball cock	1	1	12.63 EA
490-10466	Repair kit for 490-10465	1	25	3.20 KT
490-10467	Replacement bonnet for 490-10465	1	1	4.73 EA

Rubber Ballcock Washer

- Solid rubber, push-in type ballcock washer for Mansfield*

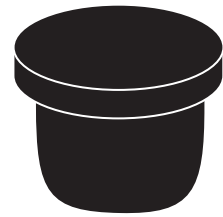

Item No.	Description	Min. Qty.	Case Qty.	List Price
490-10383	1/2" O.D. x 3/16" thick ballcock washer with tail	10	1000	0.86 EA

* Indicates the part was not made by original manufacturer, but manufactured to the same specifications as original part.

Ballcock Repair Kits

American Standard*

Coast*

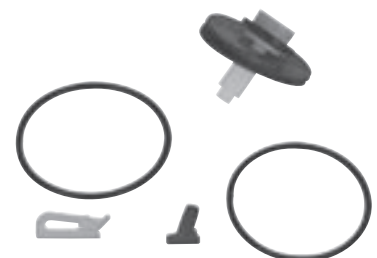

490-10375

Item No.	Description	Min. Qty.	Case Qty.	List Price
INDIVIDUALLY BAR-CODED KIT				
490-10375	American Standard* Coast style kit (047253-0070A)	1	25	4.86 KT
490-10360	Repair kit for Coast* # 1B1 ballcock	1	25	2.95 KT

* Indicates the part was not made by original manufacturer, but manufactured to the same specifications as original part.



490-10360

Save-A-Flange™ Closet Flange Repair Kit

- Renews broken closet flanges
- 3/8" stamped, zinc plated steel
- Kit includes:
 - One zinc plated bar
 - Two plastic screw anchors
 - Two 1 3/4" x #8 Phillips-head screws
 - Six poly spacer washers
 - One instruction sheet

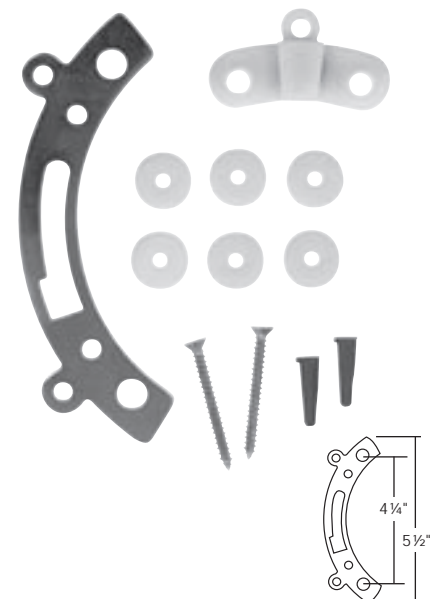

Item No.	Description	Min. Qty.	Case Qty.	List Price
BULK				
490-11321	Closet flange repair kit	50	50	5.53 KT
BAR-CODED BAGS IN A CUT CASE BOX				
490-11320	Closet flange repair kit	1	10	6.60 KT

Closet Flange Floor Support

- Repairs and replaces rotted-out flooring around closet flanges
- Heavy gauge, zinc plated steel die-cut plates
- Pre-slotted and furnished with mounting screws



Item No.	Description	Min. Qty.	Case Qty.	List Price
BAR-CODED BAGS IN A CUT CASE BOX				
490-11322	Floor flange support for closet flange, 1/bag	1	10	19.50 BG

Wedge-It™ Multi-Purpose Stability Wedge

- Stiff polypropylene is drivable
- Soft rubber-like PVC is easy to trim and resists slipping on tile floors
- Dozens of uses on the job site, in the office, home, etc.
- Corrosion proof

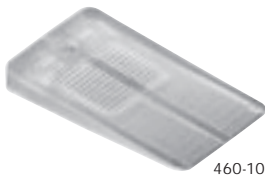

Ideal for leveling unsteady closet bowls.

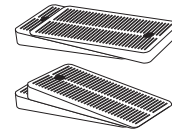

Stack in the same or opposite direction.

Item No.	Description	Min. Qty.	Case Qty.	List Price
BULK				
460-10	Stiff polypro, bulk box	100	1000	0.25 EA
460-11300	Stiff polypro job pack, 10/bag	1	10	3.00 BG
460-20	Soft pvc, bulk box	100	1000	0.34 EA
460-11310	Soft pvc job pack, 10/bag	1	10	3.80 BG
BAR-CODED BOX				
460-10TP	Stiff polypro truck pack, 30/box	1	10	11.65 BX
460-20TP	Soft pvc truck pack, 30/box	1	10	13.62 BX
460-30TP	Mixed (460-10 & 460-20) truck pack, 15 ea., 30/box	1	10	12.60 BX
BAR-CODED BAGS IN A BAR-CODED DISPENSER BOX				
460-10J	Stiff polypro, 10/bag, 20 bags/box	1	1	56.00 BX
460-20J	Soft pvc, 10/bag, 20 bags/box	1	1	72.00 BX

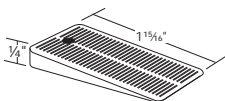

SUPPLY

DRAINAGE

SUPPORT

TESTING

SPECIALTIES

TOOLS

ACCESS

HearthMaster™ Log Lighter Kits

- Angle and straight ball valve kits
- Log lighter bar, valve, flange and key—everything you need for installation in one convenient box
- Quarter-turn style ball valves
- Log lighter bars available in two or three FIP inlets
- Chrome plated or polished brass flanges available
- Each component is individually bagged
- Our kits can be customized to fit the specific needs of most any job
- Log lighter bar is for **NATURAL GAS ONLY**



Item No.	Description	Finish	Min. Qty.	Case Qty.	List Price
ANGLE BALL VALVE KITS					
INDIVIDUALLY BAR-CODED KITS					
953	3 FIP inlets, 16 flame outlets	chrome plated flange, 3 1/4" cast zinc key	1	6	30.35 KT
953-12	2 FIP inlets, 16 flame outlets	chrome plated flange, 3 1/4" cast zinc key	1	6	30.35 KT
953-P	3 FIP inlets, 16 flame outlets	pol. brass flange, 3 1/4" pol. brass key	1	6	33.60 KT
953-12P	2 FIP inlets, 16 flame outlets	pol. brass flange, 3 1/4" pol. brass key	1	6	33.60 KT
STRAIGHT BALL VALVE KITS					
INDIVIDUALLY BAR-CODED KITS					
955	3 FIP inlets, 16 flame outlets	chrome pltd. flange, 3 1/4" cast zinc key	1	6	30.00 KT
955-12	2 FIP inlets, 16 flame outlets	chrome pltd. flange, 3 1/4" cast zinc key	1	6	30.00 KT



HearthMaster™ Log Lighter Bar

- 90,000 BTU/hour at 1/2 PSI (16 port model)
- Durable cast iron bars for **NATURAL GAS ONLY**
- Ash shield prevents ash and other debris from clogging flame outlets. To install upright, be sure the ash shield slopes downward. The words "HEARTHMASTER" and "NATURAL GAS ONLY" will read upright



Item No.	Description	Min. Qty.	Case Qty.	List Price
LOG LIGHTER BAR – 3 FIP INLETS				
BULK				
940-10	16 flame outlets (8 per side)	6	6	11.56 EA
940-11	8 flame outlets (one side)	6	6	11.56 EA
BAR-CODED CLAMSHELLS IN A CUT CASE BOX				
940-10PK1	16 flame outlets (8 per side)	10	10	13.10 EA
LOG LIGHTER BAR – 2 FIP INLETS				
940-12	16 flame outlets (8 per side)	6	6	11.56 EA
940-13	8 flame outlets (one side)	6	6	11.56 EA

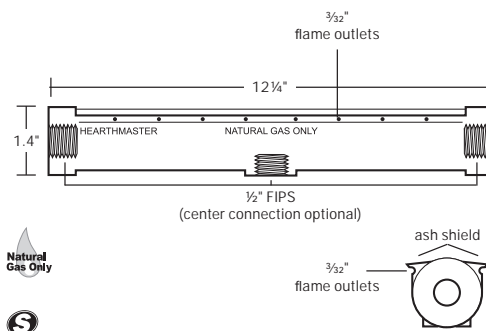

SUPPLY

DRAINAGE

SUPPORT

TESTING

SPECIALTIES

TOOLS

ACCESS

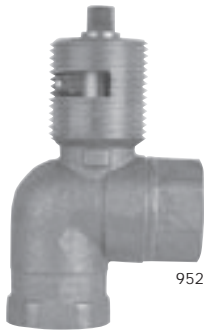

952



954



954-PK1

HearthMaster™ Gas Ball Valve

- Angle or straight ball valves
- Cast brass bodies with P.T.F.E. seats
- Available in bulk or with flange and key included
- ½" FIP × ½" FIP with ¾" NPSM flange thread
- 952: 150,000 BTU/hr @ ½ PSI
- 954: 350,000 BTU/hr @ ½ PSI
- For use with both natural gas and LP gas



When valve-to-flange connections need extending, use our 948-EX extension piece (A), or for custom extensions, use a ¾" IPS coupling and nipple (B).

Related Products
Flange to valve extension nipple p 273

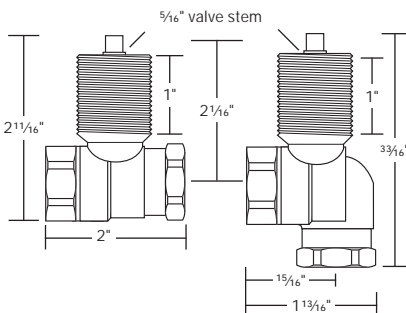

Item No.	Description	Min. Qty.	Case Qty.	List Price
ANGLE BALL VALVE				
BULK				
952	Bagged kit: valve, chrome plated flange, 949 key	1	24	21.06 EA
952-P	Bagged kit: valve, polished brass flange, 949-P key	1	6	22.15 EA
952-V	Bulk: angle ball valve only	1	12	17.20 EA
BAR-CODED CLAMSHELLS IN A CUT CASE BOX				
952-PK1	Kit: valve, chrome plated flange, 949 key	6	6	24.95 CS
952-PPK1	Kit: valve, polished brass flange, 949-P key	6	6	23.85 CS
STRAIGHT BALL VALVE				
BULK				
954	Bagged kit: valve, chrome plated flange, 949 key	1	24	19.95 EA
954-P	Bagged kit: valve, polished brass flange, 949-P key	1	6	21.50 EA
954-V	Bulk: straight ball valve only	1	24	16.95 EA
BAR-CODED CLAMSHELLS IN A CUT CASE BOX				
954-PK1	Kit: valve, chrome plated flange, 949 key	6	6	22.80 CS
954-PPK1	Kit: valve, polished brass flange, 949-P key	6	6	23.05 CS

HearthMaster™ Log Lighter Accessories

- Flanges available with chrome plated, polished brass or white enamel finish
- Keys available with polished brass finish, or zinc coated
- Longer keys and stem extensions available for applications when the valve must be installed too deep in the wall or floor for standard keys

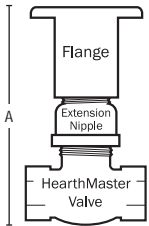

948-EX extension pieces are perfect when valve/flange connections need to be extended. Extends (A) to between 5 5/8" and 6 3/16".



Adapter/key combo tool enables fast, easy installation or replacement of flanges without scratching.

Item No.	Description	Min. Qty.	Case Qty.	List Price
FLANGE				
BULK				
948	Chrome plated	12	60	4.49 EA
948-P	Polished brass	12	12	5.09 EA
948-W	White enamel	1	12	7.12 EA
948-EX	Flange to valve extension nipple: 3/4" FIP x 3/4" MIP	12	120	1.75 EA
949-F	Flange Installation Tool – includes key	1	25	3.44 EA
BAR-CODED BAGS IN A CUT CASE BOX				
948PK2	Chrome plated, 1/bag	10	10	5.56 BG
948-PPK2	Polished brass, 1/bag	10	10	6.46 BG
KEY				
BULK				
949-1	1/4" socket, 2 7/8" long, cast zinc	12	120	1.19 EA
949-1P	1/4" socket, 2 7/8" long, polished brass	12	120	2.46 EA
949	5/16" x 1/4" dual socket, 2 7/8" long, chrome	12	120	1.58 EA
949-P	5/16" socket, 2 7/8" long, polished brass	1	12	2.66 EA
949-CP	5/16" socket, chrome	12	120	2.83 EA
949-K09	5/16" socket, 9 1/2" long, cast zinc	1	1	3.69 EA
949-K09P	5/16" socket, 9 1/2" long, polished brass	1	1	7.88 EA
949-K12	5/16" socket, 12" long, cast zinc	1	1	5.86 EA
BAR-CODED BAGS IN A CUT CASE BOX				
949-1PK2	1/4" socket, 2 7/8" long, cast zinc, 1/bag	10	10	1.56 BG
949-1PPK2	1/4" socket, 2 7/8" long, polished brass, 1/bag	10	10	3.10 BG
949PK2	5/16" socket, 2 7/8" long, cast zinc, 1/bag	10	10	2.15 BG
949-PPK2	5/16" socket, 2 7/8" long, polished brass, 1/bag	10	10	3.22 BG
949-K09PK2	5/16" socket, 9 1/2" long, cast zinc, 1/bag	10	10	4.39 BG
949-K09PPK2	5/16" socket, 9 1/2" long, polished brass, 1/bag	10	10	9.85 BG
949-OK09PK2	1/4" socket, 9 1/2" long, cast zinc, 1/bag	10	10	4.35 BG
949-OK09PPK2	1/4" socket, 9 1/2" long, polished brass, 1/bag	10	10	9.85 BG
949-K12PK2	5/16" socket, 12" long, cast zinc, 1/bag	10	10	7.35 BG
STAINLESS STEEL STEM EXTENSION				
BULK				
949-06	5/16" socket, 6" long, alignment bushings included	10	10	5.16 EA
949-10	5/16" socket, 10" long, alignment bushings included	1	10	4.90 EA
949-12	5/16" socket, 12" long, alignment bushings included	1	10	5.25 EA
949-21	5/16" socket, 21" long, alignment bushings included	1	10	7.10 EA
BAR-CODED BAGS IN A CUT CASE BOX				
949-06PK2	5/16" socket, 6" long, 1/bag	10	10	6.45 BG
949-12PK2	5/16" socket, 12" long, 1/bag	10	10	6.56 BG



948



949-F



949-K09



949-P



949-06

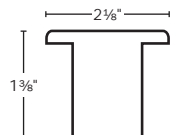

SUPPLY

DRAINAGE

SUPPORT

TESTING

SPECIALTIES

TOOLS

ACCESS





Gas Ball Valve

- Solid brass body
- Teflon® packing and seats
- Complies with ANSI Z21.15 manual valve and AGA 3-88

Item No.	Description	Min. Qty.	Case Qty.	List Price
BULK				
108-12	1/2" FIP gas ball valve	12	144	7.98 EA
108-13	3/4" FIP gas ball valve	12	144	10.60 EA
108-14	1" FIP gas ball valve	6	60	21.73 EA
INDIVIDUALLY BAR-CODED IN A CUT CASE BOX				
108-12PK	1/2" FIP gas ball valve	12	12	8.66 EA
108-13PK	3/4" FIP gas ball valve	12	12	11.67 EA



Important Note

Gas Valve Wall Installations

- Alignment bushings are **REQUIRED*** for installations where valve is set in the wall, and flange is not directly connected to the valve.

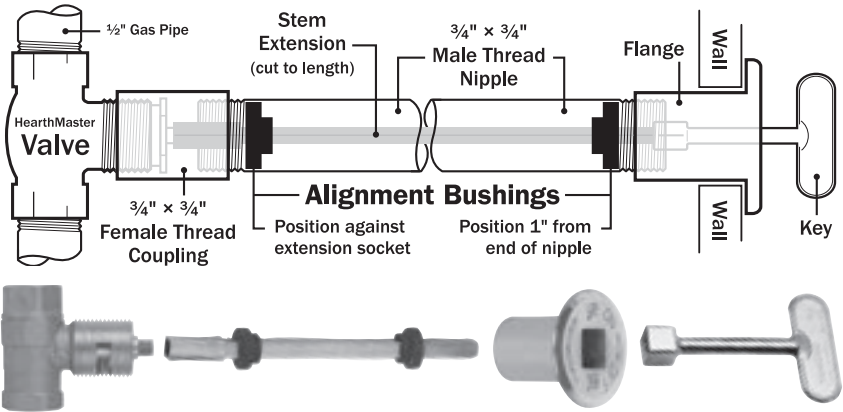

- 1 Measure distance from male threads of the valve to finished wall (or where finished wall will be) and subtract 1/2". This distance will determine the length of the 3/4" male thread steel pipe nipple (not included).
- 2 Install a 3/4" female thread steel coupling (not included) on to one end of male thread steel pipe nipple. Install coupling on the male threads of the valve. Slide the alignment bushings (2) over the male (non-socket) end of the stem extension. Position one bushing against socket of stem extension, and the other bushing 1" from end of pipe nipple.
- 3 If necessary, cut the stem extension flush with the end of the male thread steel pipe nipple. After wall is finished, insert the flange through the wall and thread on to pipe nipple. Tighten flange to the wall.

* Alignment bushings are included with all Sioux Chief stem extensions

SUPPLY

DRAINAGE

SUPPORT

TESTING

SPECIALTIES

TOOLS

ACCESS

CATALOG 2007

Tools

Saws & Cutters
Wrenches
Brushes & Abrasives
Accessories



SAWS & CUTTERS

- 277 Sawhorse™
- 277 Mini Hacksaw
- 277 Inside Pipe Cutter
- 278 Wire Cable Saw
- 278 Utility Knife
- 278 Plastic Tube Cutter
- 278 Ratchet Tube Cutter
- 279 Spin Off™
- 279 Tube Cutters

WRENCHES

- 281 Slip Joint Pliers
- 281 Heavy Duty Pipe Wrench
- 281 Power Grip Ratcheting Pipe Wrench
- 282 Offset Ratchet Box Wrench
- 282 Strap Wrench
- 282 Telescopic Basin Wrench
- 283 P.O. Plug Wrench
- 283 Faucet Nut Wrench
- 283 Socket Wrench Set
- 284 Water Heater Element Wrench
- 284 Internal Nipple Wrench Set
- 284 Faucet Seat Wrench

BRUSHES & ABRASIVES

- 285 Fitting Brushes
- 286 Tube O.D. Brush
- 286 Abrasive Mesh
- 286 Sand Cloth
- 286 Wet-Proof Cloth
- 287 Copper Cleaning Pad
- 287 Acid Brush
- 287 Pipe Dope/Cement Brush

Tools

ACCESSORIES

- 289 Crimp Tools for PEX & PB Crimp Rings
- 290 Crimp Ring Removal Tool
- 290 Metal Stud Punch
- 290 Faucet Stem Key
- 290 Moen Cartridge Puller
- 291 Faucet Handle Puller
- 291 6-in-1 Screwdriver
- 291 4pc Screw Extractor Set
- 292 O-Ring Pick
- 292 Flexible Grabber
- 292 Inspection Mirror
- 292 Match Holder
- 293 Hex Key Set
- 293 Levels
- 293 Flaring Tools
- 294 Deburring Tool
- 294 Locking Tape Measure
- 294 Silicone Lubricant
- 295 PTFE Packing Rope
- 295 PTFE Pipe Thread Tape
- 295 Duct Tape
- 296 Plunger
- 296 Cement Stop Leak
- 296 Oakum
- 297 Multi-Purpose Square Bucket
- 297 Polypro Parts Box
- 297 Corrugated Bin Box
- 298 Disposable Latex Glove
- 298 Work Gloves
- 299 Tie-Down Strap
- 299 Lumber Crayon
- 299 Safe-Flame™
- 300 Scrub Clean™
- 300 Disposable Shoe Covers
- 300 Dust Mask
- 300 Peg Board Display Hook

SUPPLY

DRAINAGE

SUPPORT

TESTING

SPECIALTIES

TOOLS

ACCESS

Sawhorse™ Multi-Purpose Saw

- High-quality, hardened-steel blade remains sharp through thousands of cuts
- Perfect for plastic pipe, wood, and many other materials
- 12" model has 13 teeth/inch for fine cutting. Teeth are on the nose for notching in tight areas and starting cuts in the middle of floor or wall
- 20" model has 10 teeth/inch for faster cutting
- Both include plastic teeth protector



12" Sawhorse has teeth on the nose for making cuts in the middle of a floor or wall

Item No.	Description	Min. Qty.	Case Qty.	List Price
300-12	12" with plastic teeth protector	12	12	15.32 EA
300-20	20" with plastic teeth protector	4	4	36.24 EA
300-12B	Replacement blade for 300-12	1	25	12.25 EA
300-20B	Replacement blade for 300-20	6	6	23.25 EA



Mini Hacksaw

Pistol Grip & Standard

- Pistol-grip model gives solid feel and true cuts. Separate screw sets the 6" blade tension
- Good for fine work in small areas. Six inch steel blade cuts copper & brass tube, bolts, steel, wood, and plaster
- Standard D-type saw is nickel plated



The compact, easy to use design gets the Mini Hacksaw into tight spaces where many hacksaws cannot fit.

Item No.	Description	Min. Qty.	Case Qty.	List Price
301-062	Deluxe pistol grip, 6" blade	10	10	11.33 EA
301-065	Standard D-type, 6" blade	20	20	2.89 EA
301-061	6" carbon steel replacement blade 32 teeth/inch, pin ends	5	100	0.68 EA



Inside Pipe Cutter

- Steel blade for plastic pipe
- Abrasive disc for plastic or steel pipe

Item No.	Description	Min. Qty.	Case Qty.	List Price
INDIVIDUALLY BAR-CODED				
390-50153	Inside pipe cutter with two 1 1/8" abrasive discs	1	10	8.54 EA
390-50154	Replacement kit: 3 discs, 1 bolt, 1 washer	1	10	7.07 EA
390-50163	Inside pipe cutter with 1 1/4" steel blade	1	10	22.62 EA
390-50164	1 1/4" hardened steel replacement blade	1	100	4.38 EA





Wire Cable Saw

- Cuts PVC pipe in tight spaces
- Disposable, good for approx. 40 cuts

Item No.	Description	Min. Qty.	Case Qty.	List Price
INDIVIDUALLY BAR-CODED				
390-50105	Wire cable saw for plastic pipe	1	25	6.62 EA



Utility Knife

- Uses standard double pointed blades

Item No.	Description	Min. Qty.	Case Qty.	List Price
BULK				
315-10	Utility knife with one blade	12	60	7.80 EA
BAR-CODED CARD				
315-1	Replacement blades, 5 blades/card	10	100	1.60 cd



Plastic Tube Cutter

- Quickly cut PEX, PB, CPVC, and other poly pipe or non-metallic hose
- For 1 1/8" O.D. tube or smaller

Item No.	Description	Min. Qty.	Case Qty.	List Price
BULK				
304-08	Plastic tube and hose cutter	6	60	16.70 EA
304-1	Stainless steel replacement blade for 304-08	1	50	7.05 EA
304-5	Carbon steel replacement blade for old style 304-08	10	50	7.05 EA



Ratchet Tube Cutter

- For use with PVC and polyethylene piping
- Easy, one-handed, ratchet cutting action
- Cuts 1/2" thru 1 1/4" pipe

Item No.	Description	Min. Qty.	Case Qty.	List Price
INDIVIDUALLY BAR-CODED				
304-10	Ratchet-style tubing cutter	1	36	82.00 EA
304-15	Replacement blade	1	12	40.25 EA

SUPPLY

DRAINAGE

SUPPORT

TESTING

SPECIALTIES

TOOLS

ACCESS

Spin Off™ Plastic Tube Cutter

- Quickly cut PEX and other composite pipe—without crushing tube
- For ½" and ¾" O.D. tube
- Replaceable stainless steel blade



Item No.	Description	Min. Qty.	Case Qty.	List Price
INDIVIDUALLY BAR-CODED IN A REUSABLE POUCH				
304-09PK1	Tube cutter with tubing reamer	1	1	19.95 EA
304-9	Replacement cutting cassette	1	25	5.75 EA

NEW Tube Cutters

Mini Cutter

- ¼"–5/8" capacity
- Large ribbed feed screw knob



304-20

Internal Adjustment Cutter

- ½"–1½" capacity
- Extra cutter wheel in body
- Body and knob made of lightweight aluminum
- Telescoping feed mechanism keeps turning radius constant

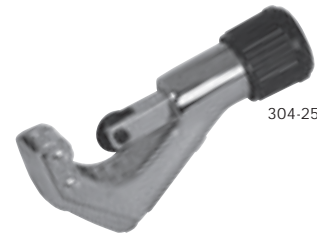

304-25

External Adjustment Cutter

- ¾"–1¼" capacity
- Aluminum alloy die cast body with zip adjustable action
- Spare cutter wheel in knob

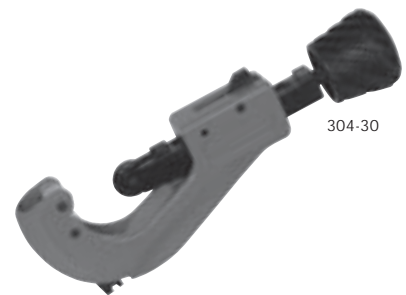

304-30



The 304-25 has a built-in deburring tool.



The 304-30 has a removable deburring tool in its body.

Item No.	Description	Min. Qty.	Case Qty.	List Price
INDIVIDUALLY BAR-CODED				
304-20	Mini cutter	1	100	6.50 EA
304-25	Internal adjustment cutter with deburring tool	1	10	25.42 EA
304-30	External adjustment cutter with deburring tool	1	10	9.95 EA
304-32	Replacement wheel for 304-25/304-30	1	20	2.95 EA

Slip Joint Pliers

Milled and Smooth Jaw

- Nickel plated finish with plastic grips
- Angle-nose pliers have Grip Tight clip
- Pipe wrench pliers have seven tongue-in-groove adjustments
- Mini model has three-position adjustable jaws
- Smooth jawed models protect surface from marring and scratches

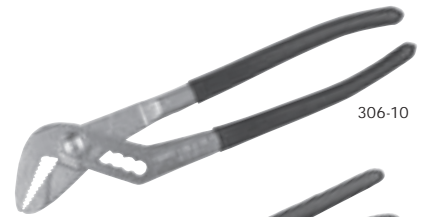

306-10



309-10



390-50191

Item No.	Description	Jaws	Max. Opening	Min. Qty.	Case Qty.	List Price
INDIVIDUALLY BAR-CODED BULK						
306-10	10" angle-nose pliers	milled	1½"	10	10	19.25 EA
309-10	10" 90° pipe wrench pliers	milled	2½"	4	40	24.80 EA
390-50191	6¾" mini angle-nose pliers	milled	¾"	1	10	15.76 EA
NEW 306-12	10" angle-nose pliers	smooth	1½"	1	5	22.82 EA
NEW 309-12	10" 90° pipe wrench pliers	smooth	2½"	1	5	27.50 EA

NEW Heavy Duty Pipe Wrench

- I-beam cast iron handle
- Heat treated alloy steel jaw

Item No.	Description	Min. Qty.	Case Qty.	List Price
INDIVIDUALLY BAR-CODED BULK				
313-08	8" heavy duty pipe wrench	1	6	37.49 EA
313-10	10" heavy duty pipe wrench	1	6	56.65 EA
313-14	14" heavy duty pipe wrench	1	6	72.25 EA
313-18	18" heavy duty pipe wrench	1	6	102.45 EA



NEW Power Grip Ratcheting Pipe Wrench

- Self-adjusting head quickly sets to any position automatically without clumsy turn-screw adjustments
- Works at every head angle through 360°
- Fits all shapes: hex, square or round
- The harder you press, the tighter it grips
- Drop forged jaws



Ratcheting head action

Item No.	Description	Min. Qty.	Case Qty.	List Price
INDIVIDUALLY BAR-CODED BULK				
313-25	10" ratcheting pipe wrench	1	12	52.52 ea
313-26	14" ratcheting pipe wrench	1	10	85.40 ea



SUPPLY

DRAINAGE

SUPPORT

TESTING

SPECIALTIES

TOOLS

ACCESS



Offset Ratchet Box Wrench

- 25° offset angle
- Reach tight situations without scraping your knuckles
- Speed and convenience of ratcheting box wrench
- Reverse by flipping lever

Item No.	Description	Min. Qty.	Case Qty.	List Price
INDIVIDUALLY BAR-CODED BULK				
316-1	3/8" x 7/16" box wrench	1	6	23.50 EA
316-2	1/2" x 9/16" box wrench	1	6	23.50 EA



Strap Wrench

- Reinforced rubber strap
- Works in tight areas
- Adjust to fit any irregular shape
- 8" handle

Item No.	Description	Min. Qty.	Case Qty.	List Price
INDIVIDUALLY BAR-CODED BULK				
313-20	Strap wrench	1	12	19.90 EA



Telescopic Basin Wrench

- Jaw capacity: 3/8"-1 1/8"
- Nickel plated finish for long life
- 6" long leverage bar
- Length adjusts to 9 1/2", 12", 14", and 16 1/2"

Item No.	Description	Min. Qty.	Case Qty.	List Price
INDIVIDUALLY BAR-CODED BULK				
390-50197	Telescopic basin wrench	1	20	17.35 EA

P.O. Plug Wrench

- Malleable iron
- Holds P.O. plug and basket straight during installation

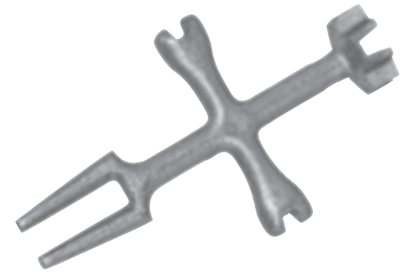

Item No.	Description	Min. Qty.	Case Qty.	List Price
INDIVIDUALLY BAR-CODED BULK				
390-50198	Pop-up plug wrench	1	20	5.64 EA

Faucet Nut Wrench

- Fits over multiple sizes of plastic faucet nuts



Item No.	Description	Min. Qty.	Case Qty.	List Price
INDIVIDUALLY BAR-CODED BULK				
390-50310	Faucet nut wrench—ABS	1	12	11.00 EA

Socket Wrench Set

for Tub/Shower Valves

- Each set includes the following wrenches:
 $2\frac{1}{32}'' \times 2\frac{7}{32}''$, $2\frac{9}{32}'' \times 3\frac{1}{32}''$, $1\frac{1}{32}'' \times 1\frac{3}{32}''$, $1\frac{5}{32}'' \times 1\frac{9}{32}''$,
 $1\frac{11}{32}'' \times 1\frac{7}{16}''$, and one 5" turning bar
- Wrenches are $4\frac{3}{8}''$ deep



Item No.	Description	Min. Qty.	Case Qty.	List Price
INDIVIDUALLY BAR-CODED BULK				
311-10	Set with carrier handle	1	10	32.96 EA



Water Heater Element Wrench

- 1 1/2" hex, heavy duty plated steel
- 1/8" wall thickness, 3 3/4" long
- Hole is 1 1/32" for leverage bar (not included)

Item No.	Description	Min. Qty.	Case Qty.	List Price
INDIVIDUALLY BAR-CODED BULK				
390-50185	Water heater element wrench	1	10	9.10 EA



Internal Nipple Wrench Set

- Internal wrench set includes wrenches for 3/8", 1/2" and 3/4" IPS nipples

Item No.	Description	Min. Qty.	Case Qty.	List Price
INDIVIDUALLY BAR-CODED BULK				
390-50120	Wrench set for 3/8", 1/2" & 3/4" IPS	1	10	38.75 EA
390-50122	Wrench for 1/2" IPS - cam type	1	100	13.66 EA



Faucet Seat Wrench

- 390-50130 ratchet faucet seat wrench set has two square and one hex tool plus ratchet



390-50130 comes in resealable case

Item No.	Description	Min. Qty.	Case Qty.	List Price
INDIVIDUALLY BAR-CODED BULK				
390-50130	Ratchet wrench set	1	25	44.21 EA
390-50132	Straight wrench tool	1	12	6.09 EA
390-50133	Angle wrench tool	1	12	8.28 EA

SUPPLY

DRAINAGE

SUPPORT

TESTING

SPECIALTIES

TOOLS

ACCESS

Fitting Brushes

Deluxe Wood Handle

- Solid wood, screwdriver type handle is easy to hold and turn
- Carbon or stainless steel bristles

Plastic Handle

- Carbon or stainless steel bristles

Open-Loop Handle

- Carbon or stainless steel bristles

Drill Attachment

- Stem fits all power drill chucks
- Carbon or stainless steel bristles



701-2



705-3



702-2



706-4

Item No.	Description	Bristles	Min. Qty.	Case Qty.	List Price
DELUXE WOOD HANDLE					
701-2	½" CTS	carbon steel	12	120	2.00 EA
701-3	¾" CTS	carbon steel	12	120	2.10 EA
701-4	1" CTS	carbon steel	12	120	2.32 EA
704-2	½" CTS	stainless steel	12	120	2.10 EA
704-3	¾" CTS	stainless steel	12	120	2.18 EA
704-4	1" CTS	stainless steel	12	120	2.45 EA
PLASTIC HANDLE					
700-0	¼" CTS	carbon steel	12	120	1.98 EA
700-1	⅜" CTS	carbon steel	12	120	1.98 EA
700-2	½" CTS	carbon steel	12	120	1.98 EA
700-3	¾" CTS	carbon steel	12	120	2.05 EA
700-4	1" CTS	carbon steel	12	120	2.25 EA
700-5	1¼" CTS	carbon steel	6	60	2.45 EA
700-6	1½" CTS	carbon steel	6	60	2.70 EA
700-7	2" CTS	carbon steel	6	60	3.10 EA
705-2	½" CTS	stainless steel	12	120	4.60 EA
705-3	¾" CTS	stainless steel	12	120	4.78 EA
705-4	1" CTS	stainless steel	12	120	4.82 EA
OPEN-LOOP HANDLE					
702-2	½" CTS	carbon steel	24	240	1.32 EA
702-3	¾" CTS	carbon steel	24	240	1.36 EA
702-4	1" CTS	carbon steel	24	240	1.58 EA
703-2	½" CTS	stainless steel	24	240	1.36 EA
703-3	¾" CTS	stainless steel	24	240	1.44 EA
703-4	1" CTS	stainless steel	24	240	1.74 EA
703-5	1¼" CTS	stainless steel	12	120	2.42 EA
703-6	1½" CTS	stainless steel	6	60	2.62 EA
703-7	2" CTS	stainless steel	6	60	2.94 EA
DRILL ATTACHMENT					
706-2	½" CTS	carbon steel	6	60	1.32 EA
706-3	¾" CTS	carbon steel	6	60	1.36 EA
706-4	1" CTS	carbon steel	6	60	1.78 EA
707-2	½" CTS	stainless steel	6	60	1.39 EA
707-3	¾" CTS	stainless steel	6	60	1.44 EA
707-4	1" CTS	stainless steel	6	60	1.54 EA

SUPPLY

DRAINAGE

SUPPORT

TESTING

SPECIALTIES

TOOLS

ACCESS



Tube O.D. Brush

- High impact, hex body for better grip
- Carbon steel bristles

Item No.	Description	Min. Qty.	Case Qty.	List Price
710-2	½" CTS	6	120	4.78 EA
710-3	¾" CTS	6	120	5.36 EA
710-4	1" CTS	6	120	6.08 EA



Abrasive Mesh

- 180 grit open mesh is waterproof
- Rinse when mesh gets loaded with debris

Item No.	Description	Min. Qty.	Case Qty.	List Price
INDIVIDUALLY BAR-CODED BULK				
730-05	5 yard roll in dispenser box	1	24	8.34 EA
730-10	10 yard roll in dispenser box	1	24	11.89 EA
730-25	25 yard roll in dispenser box	1	12	28.28 EA



Sand Cloth

- 120 grit brown cloth is water resistant

Item No.	Description	Min. Qty.	Case Qty.	List Price
INDIVIDUALLY BAR-CODED BULK				
740-02	2 yard roll in bag	1	50	1.80 EA
740-05	5 yard roll in dispenser box	1	24	3.19 EA
740-10	10 yard roll in dispenser box	1	24	5.95 EA
740-25	25 yard roll in dispenser box	1	12	13.28 EA



Wet-Proof Cloth

- 120 grit blue-green cloth is 100% waterproof
- Unaffected by water, cutting oils, grease, etc.

Item No.	Description	Min. Qty.	Case Qty.	List Price
INDIVIDUALLY BAR-CODED BULK				
743-05	5 yard roll in dispenser box	1	24	4.62 EA
743-10	10 yard roll in dispenser box	1	24	8.26 EA
743-25	25 yard roll in dispenser box	1	12	19.62 EA

SUPPLY

DRAINAGE

SUPPORT

TESTING

SPECIALTIES

TOOLS

ACCESS

Copper Cleaning Pad

- Cleans copper tube and fittings for soldering
- Great general purpose cleaning pad
- Use wet or dry



Item No.	Description	Min. Qty.	Case Qty.	List Price
750-46	4" x 6" x 1/4" fine grit, red nylon pad, 10 pads/bag	1	14	8.60 BG
750-69	6" x 9" x 1/4" fine grit, tight weave red nylon pad, 5 pads/bag	1	12	7.30 BG
752-69	6" x 9" x 1/4" medium grit, loose weave, green nylon pad, 5 pads/bag	1	12	4.74 BG

Acid Brush

- Available 3/8" or 1/2" wide
- 100% horse hair bristles



Item No.	Description	Min. Qty.	Case Qty.	List Price
771	# 1 metal handle acid brush 3/8" wide, 6" long, 100% horse hair, 144/bag	1	12	18.61 BG
772	# 2 metal handle acid brush 1/2" wide, 6" long, 100% horse hair, 144/bag	1	12	23.86 BG

Pipe Dope/Cement Brush

- Wood handle



Item No.	Description	Bristles	Min. Qty.	Case Qty.	List Price
773	3/4" wide	horse hair	36	360	1.43 EA
774	1" wide	natural	36	36	1.84 EA
776	1 1/2" wide	natural	24	24	2.69 EA
777	2" wide	natural	24	24	3.21 EA

Crimp Tools for PEX & PB Crimp Rings

Standard Steel Handle

- Longer length promotes productivity and minimizes user fatigue

Standard Composite Handle

- Handles are strong and durable, yet lightweight

Ratcheting Compact

- Provides maximum efficiency and convenience
- Full-cycle mechanism assures consistent crimps to ASTM specs

Offset Compact

Combo & Combo Kit

Block Style

- Close quarter tool crimps rings to ASTM F-1807 on 3/8" through 1" pipe

Go/No-Go Gauge

- Included with crimp tools and available separately. (for PEX and PB crimps)



305-10



305-10CPK1



305-92R



305-91



305-23



305-23CKIT



305-100PK1



305-95

Item No.	Description	Length	Min. Qty.	Case Qty.	List Price
STANDARD STEEL HANDLE					
INDIVIDUALLY BAR-CODED BULK					
305-10	3/8" standard, steel handle	16"	1	12	214.04 EA
305-20	1/2" standard, steel handle	16"	1	12	214.04 EA
305-30	3/4" standard, steel handle	16"	1	12	214.04 EA
305-40	1" standard, steel handle	16"	1	12	260.00 EA
STANDARD COMPOSITE HANDLE					
BAR-CODED CLAMSHELLS IN A CUT CASE BOX					
305-10CPK1	3/8" composite handle	14"	1	1	180.00 EA
305-30CPK1	3/4" composite handle	14"	1	10	180.00 EA
RATCHETING COMPACT					
INDIVIDUALLY BAR-CODED BULK					
305-92R	1/2" compact ratcheting tool	11"	1	1	225.00 EA
OFFSET COMPACT					
INDIVIDUALLY BAR-CODED BULK					
305-91	3/8" standard, steel handle	11"	1	20	253.50 EA
305-92	1/2" standard, steel handle	11"	1	20	253.50 EA
305-93	3/4" standard, steel handle	11.5"	1	20	253.50 EA
COMBO					
INDIVIDUALLY BAR-CODED BULK					
305-23	1/2" over 3/4", steel handle	16"	1	1	212.50 EA
305-23CPK1	1/2" over 3/4", composite handle	14"	1	1	200.00 EA
COMBO KIT					
INDIVIDUALLY BAR-CODED BULK					
305-23CKIT	1/2" over 3/4", composite handle tool, spin-off tubing cutter, and crimp gauge in plastic carry case	14"	1	16	269.99 EA
BLOCK STYLE					
INDIVIDUALLY BAR-CODED IN A CUT-CASE BOX					
305-100PK1	3/8"-1" crimp tool with go/no-go gauge	-	1	10	55.00 EA
GO/NO-GO GAUGE					
INDIVIDUALLY BAR-CODED BULK					
305-95	Go/No-Go gauge	-	1	12	4.40 EA

SUPPLY

DRAINAGE

SUPPORT

TESTING

SPECIALTIES

TOOLS

ACCESS



NEW Crimp Ring Removal Tool

- Allows for fitting recovery without damaging the fitting sealing surfaces
- Suitable for use on 1/2" through 1" PEX pipe sizes
- Cutting blade only penetrates the ring and pipe
- Two cuts on ring allows user to reclaim fitting

Item No.	Description	Min. Qty.	Case Qty.	List Price
INDIVIDUALLY BAR-CODED BULK				
305-99	Crimp ring removal tool	1	10	85.00 EA



Metal Stud Punch

- Punches 1 1/2" hole size in 20 gauge steel 3 1/2" from edge
- Lightweight, high strength aluminum alloy
- Offset handle gets into tight spaces easier
- Non-slip rubber grips

Item No.	Description	Length	Min. Qty.	Case Qty.	List Price
INDIVIDUALLY BAR-CODED BULK					
305-521	Punch for 1 1/2" hole	21"	1	1	474.49 EA



Faucet Stem Key

- Fits: 1/4", 9/32", 5/16" & 11/32" faucet and sillcock stems

Item No.	Description	Min. Qty.	Case Qty.	List Price
INDIVIDUALLY BAR-CODED BULK				
390-50134	Four-way faucet stem key	1	12	3.91 EA



Moen* Cartridge Puller

- Removes Moen* #1200 and #1225 cartridges

Item No.	Description	Min. Qty.	Case Qty.	List Price
INDIVIDUALLY BAR-CODED BULK				
390-50128	Puller for Moen*	1	12	14.47 EA

* The part is not made by original manufacturer but manufactured to same specifications as original part.

Faucet Handle Puller

Screw Type

- Economical screw type pulls handles with a twist of the wrist

NEW Jumbo

- Removes larger handles with longer adjustable puller arms
- One piece cast cross bar for strength and durability
- Puller features notches to ensure positive and equal positioning of puller arms on cross bar
- Alloy steel components

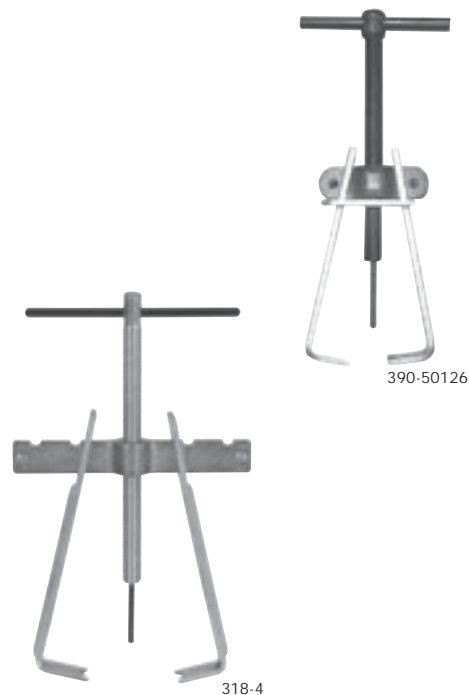

Item No.	Description	Min. Qty.	Case Qty.	List Price
INDIVIDUALLY BAR-CODED BULK				
390-50126	Screw type puller	1	25	18.22 EA
318-4	Jumbo handle puller	1	5	34.15 EA

6-in-1 Screwdriver

- Includes one dual ended slotted bit, one dual ended Phillips bit and one 5/16" x 1/4" nut driver shank

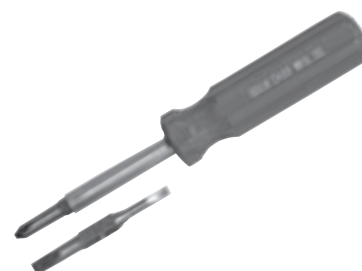

Item No.	Description	Min. Qty.	Case Qty.	List Price
314-10	Six-in-one screwdriver, red handle – display pack	12	12	8.81 EA
314-1	Replacement dual slotted bit – 5/16" shank	10	100	3.60 EA
314-3	Replacement dual Phillips bit – 1/4" shank	10	100	3.60 EA

NEW 4-Piece Screw Extractor Set

- Gradual taper and long flutes machined close to cutting edges for tightest grip
- Forged from alloy steel
- Industrial black finish
- Government spec GGG-E-936C
- Durable pouch



Item No.	Description	Min. Qty.	Case Qty.	List Price
318-20	Bolt sizes 3/4"-1 3/8", pipe size 1/2"-3/4"	1	5	55.00 EA

SUPPLY



DRAINAGE

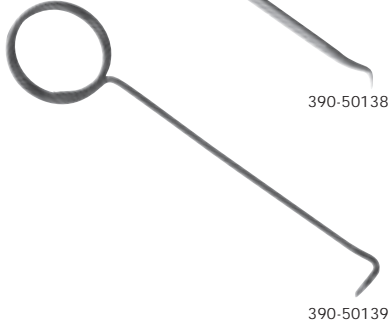

SUPPORT

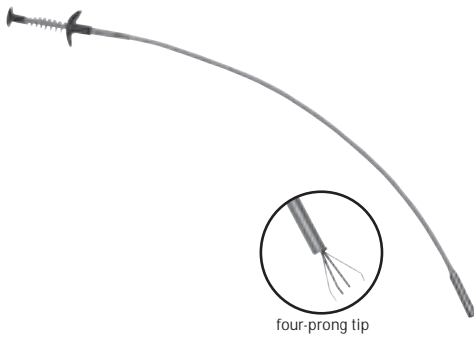

TESTING

SPECIALTIES



TOOLS

ACCESS



O-Ring Pick

- Deluxe tool with grip handle is made in USA

Item No.	Description	Min. Qty.	Case Qty.	List Price
INDIVIDUALLY BAR-CODED BULK				
390-50138	Deluxe o-ring pick with grip handle	1	12	6.26 EA
390-50139	Economy o-ring pick with loop handle	1	12	1.86 EA

Flexible Grabber

- 23" long

Item No.	Description	Min. Qty.	Case Qty.	List Price
INDIVIDUALLY BAR-CODED BULK				
390-50117	23" flexible grabber	1	25	4.42 EA

Inspection Mirror

- 1" x 2" oval mirror with angle ball joint
- Powerful long life magnetic tip
- Pocket clasp
- Extends 5 $\frac{5}{8}$ "–18 $\frac{3}{4}$ "

Item No.	Description	Min. Qty.	Case Qty.	List Price
INDIVIDUALLY BAR-CODED BULK				
390-50115	Extendable inspection mirror with magnetic tip	1	24	14.75 EA

Match Holder

- Extends 6"–25"
- Pocket clasp

Item No.	Description	Min. Qty.	Case Qty.	List Price
INDIVIDUALLY BAR-CODED BULK				
390-50110	Extendable match holder with pocket clasp	1	25	6.86 EA

NEW Hex Key Set

- 9 pc fold-up



Item No.	Description	Min. Qty.	Case Qty.	List Price
INDIVIDUALLY BAR-CODED BULK				
318-9	¼"-5/64" hex key set	1	10	14.25 EA

NEW Levels

Surface

- Levels horizontal and vertical at the same time
- 1¾" O.D.



310-10

Torpedo

- Strong, accurate 9" polycast frame
- Non-conductive frame
- Vials read plumb, level and 45°



310-09

Pocket

- Strong molded frame
- Top read window
- Durable pocket clip
- 5" in length



310-08

Item No.	Description	Min. Qty.	Case Qty.	List Price
INDIVIDUALLY BAR-CODED BULK				
310-10	Surface level	1	24	3.00 EA
310-09	Torpedo level	1	12	6.60 EA
310-08	Pocket level	1	24	5.50 EA

NEW Flaring Tools

"Papco" Style Deluxe

- ¾" O.D. to ⅝" O.D.

Economy 45° Flare

- S.A.E. 45° flare
- ¾" O.D. to ⅝" O.D.

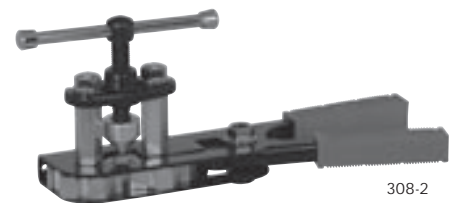

308-2



308-5

Item No.	Description	Min. Qty.	Case Qty.	List Price
INDIVIDUALLY BAR-CODED BULK				
308-2	"Papco" style deluxe flaring tool	1	12	61.30 EA
308-5	Economy 45° flaring tool	1	5	46.52 EA

SUPPLY

DRAINAGE

SUPPORT

TESTING

SPECIALTIES

TOOLS

ACCESS



NEW Deburring Tool

- Plastic body
- High carbon steel blade
- Blade storage in body

Item No.	Description	Min. Qty.	Case Qty.	List Price
INDIVIDUALLY BAR-CODED BULK				
304-06	Deburring tool	1	24	9.90 EA
304-6B	Spare blade, 5/bag	1	50	9.75 EA



Locking Tape Measure

- Heavy duty 1" wide tape
- High-impact poly case with rubberized grips
- Thumb lock with power return
- Reinforced end catch
- Belt clip
- 1/32" and 1/16" gradations

Item No.	Description	Min. Qty.	Case Qty.	List Price
INDIVIDUALLY BAR-CODED BULK				
310-05	25 foot locking tape measure	1	12	17.37 EA



Silicone Lubricant

for O-Rings & Valve Stems

- Dow Corning 111, FDA approved
- Does not deteriorate o-rings and other EPDM, buna, and rubber seats or seals
- Temperature range -40° F to 400° F



Squeeze sides and flip top with thumb.

Item No.	Description	Min. Qty.	Case Qty.	List Price
963-01	Silicone lubricant - 1/4 oz. tub	24	240	2.28 EA

PTFE Packing Rope

- PTFE (Polytetrafluoroethylene)



Item No.	Description	Min. Qty.	Case Qty.	List Price
291-30400	24" x 3/32" P.T.F.E. packing rope	24	240	1.66 EA

PTFE Pipe Thread Tape

- PTFE (Polytetrafluoroethylene)
- 1/2" and 3/4" widths



Specifications

Thickness	3 mils
Elongation	50% plus
Temp Range	-400°F to 500°F
Density	4 lbs./in ³
Material	Polytetrafluoroethylene

Item No.	Description	Min. Qty.	Case Qty.	List Price
335-260	1/2" x 260" (21.66 ft) spool	100	500	0.44 EA
335-520	1/2" x 520" (43.33 ft) spool	100	500	0.54 EA
335-263	3/4" x 260" (21.66 ft) spool	70	350	0.88 EA
335-523	3/4" x 520" (43.33 ft) spool	70	350	0.99 EA

Duct Tape

Industrial Grade

HVAC Grade

- Rolls shown are same length—HVAC grade has more adhesive



Specifications

	Industrial	HVAC
Grade	Industrial	HVAC
Thickness	10.5 mils	13 mils
Tensile Strength	24 lbs./in. width	35 lbs./in. width
Adhesion to Steel	65 oz./in.	80 oz./in.
Elongation	8%	16%

Item No.	Description	Min. Qty.	Case Qty.	List Price
330-260	2" wide x 60 yard roll, industrial grade	24	24	7.85 EA
332-260	2" wide x 60 yard roll, HVAC grade	24	24	18.20 EA



312-2

390-50148

Plunger

- 312-2 has a funnel-shaped cap which is retractable for use in flat sinks
- 390-50148 has an extra large bulb for extra thrust

Item No.	Description	Min. Qty.	Case Qty.	List Price
BULK				
312-2	Funnel type rubber plunger – 20" handle	18	18	8.95 EA
INDIVIDUALLY BAR-CODED BULK				
390-50148	Bulb type rubber plunger – 18" handle	1	12	9.22 EA



Cement Stop Leak

- Perfect for patching sewer outlet, water service and around drains
- Sets up in five minutes
- Mixing cups included in each jar
- 5 lb. plastic jar

Item No.	Description	Min. Qty.	Case Qty.	List Price
963-05	Cement stop leak, 5 lb. plastic jar	5	5	12.63 EA



Oakum

- Use to pack spigot type cast iron pipe, cracks around doors, windows, driveways, etc.
- Does not irritate skin

Item No.	Description	Min. Qty.	Case Qty.	List Price
963-15PK2	Brown oakum 1 lb/bag	20	20	12.78 EA

SUPPLY

DRAINAGE

SUPPORT

TESTING

SPECIALTIES

TOOLS

ACCESS

Multi-Purpose Square Bucket

- Heavy duty plastic, 4.25 gallon
- Great for carrying tools, fittings, almost anything
- Tight-fitting lid is included
- Buckets stack neatly together

Item No.	Description	Min. Qty.	Case Qty.	List Price
968-04	Bucket, 4.25 gallon	8	8	8.77 EA



Polypro Parts Box

- Durable clear polypropylene box with snap down lid and pegboard tab
- Perfect on the job for o-rings, washers, screws or around the house for fishing tackle, sewing kits, first aid, etc.

Item No.	Description	Min. Qty.	Case Qty.	List Price
965-01	1 section box	1	30	2.12 EA
965-02	2 section box	1	30	2.16 EA
965-04	4 section box	1	30	2.12 EA
965-06	6 section box	1	30	2.12 EA



Corrugated Bin Box

- Perfect for warehouse, fab shop, on the truck, in the office or at home
- Fits standard 12" or 18" deep shelving

Item No.	Description	Min. Qty.	Case Qty.	List Price
965-204	12" deep x 4" wide x 4 1/2" high	25	25	1.47 EA
965-208	12" deep x 8" wide x 4 1/2" high	25	25	2.15 EA
965-212	12" deep x 12" wide x 4 1/2" high	25	25	2.78 EA
965-804	18" deep x 4" wide x 4 1/2" high	25	25	2.32 EA
965-808	18" deep x 8" wide x 4 1/2" high	25	25	2.77 EA
965-812	18" deep x 12" wide x 4 1/2" high	25	25	2.99 EA

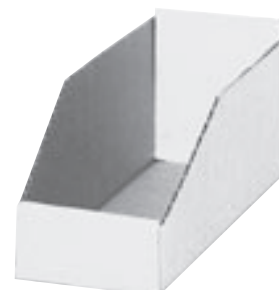

SUPPLY

DRAINAGE

SUPPORT

TESTING

SPECIALTIES

TOOLS

ACCESS



Disposable Latex Glove

- Extra large disposable latex gloves
- Powder-free, fits right or left hand
- This product contains natural rubber latex which may cause allergic reactions in some individuals

Item No.	Description	Min. Qty.	Case Qty.	List Price
390-50178	Standard weight, extra large – Job Pack	10	100	0.40 EA
390-50179	Standard weight, extra large	100	500	0.28 EA
390-50177	Heavy duty, extra large	50	250	0.46 EA

Work Gloves

- 961-20: 100% cotton, medium weight (9 oz.) with knit wrist
- 961-22: Seamless, 100% cotton knit with rubber gripper dots, ambidextrous
- 961-50: Seamless, 100% cotton knit, with non-slip palm and fingertips
- 961-30: Leather, seamless “gun cut” palm area, waterproof cuff, elastic wrist
- 961-32/961-34: All leather, elastic wrist, available in large or x-large



961-20



961-22



961-50



961-30



961-32

Item No.	Description	Min. Qty.	Case Qty.	List Price
961-20	Brown jersey gloves	24	24	2.38 PR
961-22	Knit gloves with gripping dots	24	24	2.90 PR
961-50	Knit gloves with non-slip palm	10	160	3.90 PR
961-30	Leather palm gloves with cuff	6	6	9.28 PR
961-32	All leather gloves large	1	12	16.16 PR
961-34	All leather gloves extra large	1	12	16.16 PR

Tie-Down Strap

- Super-strong 100% EPDM material with 2½" galvanized S hook



Item No.	Description	Length	Maximum Length	Min. Qty.	Case Qty.	List Price
319-09	EPDM tie-down strap	9"	14"	50	50	1.82 EA
319-15	EPDM tie-down strap	15"	22"	50	50	2.33 EA
319-20	EPDM tie-down strap	20"	30"	50	50	2.50 EA
319-31	EPDM tie-down strap	31"	45"	50	50	3.17 EA

Lumber Crayon

- Lead-free crayon is weather resistant
- Use on lumber, copper, steel, cast iron, concrete, plastic, cardboard, etc.
- Hex shape won't roll around



Item No.	Description	Color	Min. Qty.	Case Qty.	List Price
962-4	½" × 4⅝" lumber crayon	yellow	12	432	1.68 EA
962-41	½" × 4⅝" lumber crayon	blue	12	432	1.68 EA
962-42	½" × 4⅝" lumber crayon	red	12	432	1.68 EA
962-43	½" × 4⅝" lumber crayon	orange	12	432	1.68 EA

Safe-Flame™ Flame Protection Pad

- Absorbs heat
- No smoke or odor
- Non asbestos
- 9" × 12" blanket

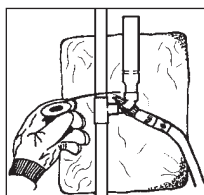

Use when soldering or brazing near wood, paint or other flammable materials.



Item No.	Description	Min. Qty.	Case Qty.	List Price
INDIVIDUALLY BAR-CODED				
390-50160	Flame protection blanket	1	25	15.62 EA



Scrub Clean™ All Purpose Hand Cleaner

- Waterless, antiseptic hand cleaner with lanolin
- Wide mouth, 16 oz. squeeze bottle fits in tool box, on work bench or keep it in your truck
- Safely removes: Pipe dope, cements, caulking, epoxy resins, paint, tile cement and other tough materials
- Use hole to hang bottle over sink or work bench

Item No.	Description	Min. Qty.	Case Qty.	List Price
963-08	Pumice cleaner – 1 pint bottle	12	12	7.85 EA



Disposable Shoe Covers

- Covers dirty work boots—saves clean up time
- Blue-spun polypropylene, non-waterproof
- Fits over shoe sizes 5–15

Item No.	Description	Min. Qty.	Case Qty.	List Price
390-50176	Bulk shoe covers	50	50	0.89 EA
390-50175	Job Pack shoe covers	1	20	2.04 PR



Dust Mask

- Comfortable, contour shape
- Non irritating—fiberglass free
- Fluid resistant
- Not for protection against asbestos, silica, cotton dust, gasses, mists, vapors, or spray paint operations

Item No.	Description	Min. Qty.	Case Qty.	List Price
390-50180	Dust mask – job pack	2	20	1.15 EA
390-50181	Dust mask – bulk	10	50	0.68 EA



Peg Board Display Hook

- 8" long × 3/16" wire
- Works with 1/4" or 5/16" holes

Item No.	Description	Min. Qty.	Case Qty.	List Price
390-50200	Peg board hook	10	50	0.67 EA

SUPPLY

DRAINAGE

SUPPORT

TESTING

SPECIALTIES

TOOLS

ACCESS

CATALOG 2007

Access

Outlet Boxes
Access Panels

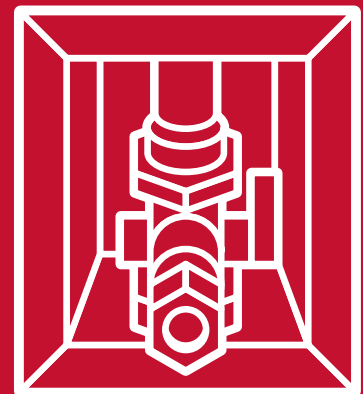

OUTLET BOXES

- 303-305 Ox Box™
- 306 Ox Box™ Washing Machine Outlet Box
- 307 Ox Box™ Ice Maker Outlet Box
- 308 Ox Box™ Accessories
- 308 Frame
- 308 Outlet Box
- 308 Box Clip
- 308 Shank Nut
- 308 Secondary Drainage Funnel

ACCESS PANEL

- 310 One Piece Access Panel
- 310 Two Piece Access Panel

Access

SUPPLY

DRAINAGE

SUPPORT

TESTING

SPECIALTIES

TOOLS

ACCESS

Ox Box™ Outlet Box

Patent Pending

- Separate supply and drain boxes offer fast and flexible layout
- Strong and fast mounting over the stud
- Durable ABS stands up to job site abuse
- Easy to test with integrated Grip Tip test nipple
- Drain knockout easily removes in one piece
- High-quality quarter-turn ball valves
- Available for washing machine and ice maker applications



Outlet Boxes

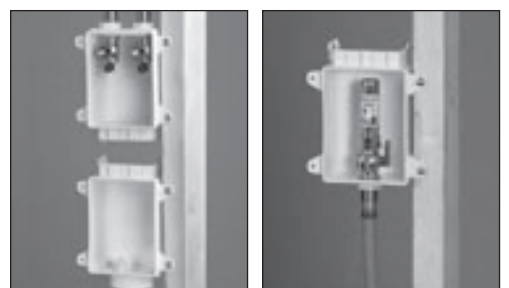
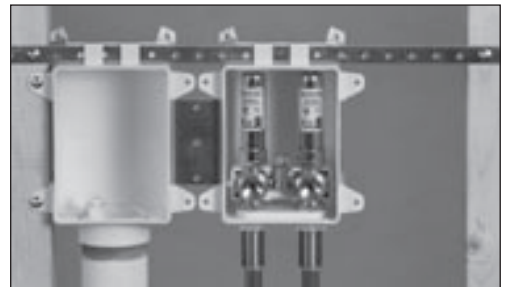
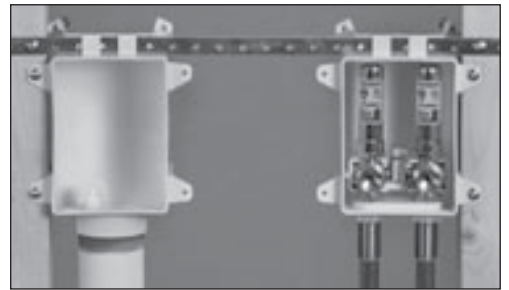
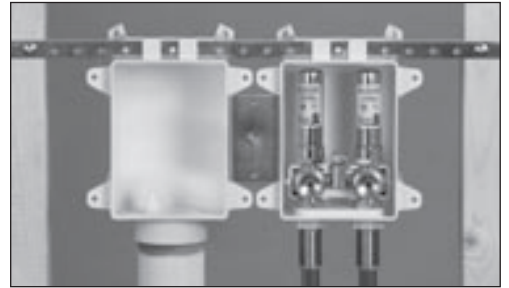
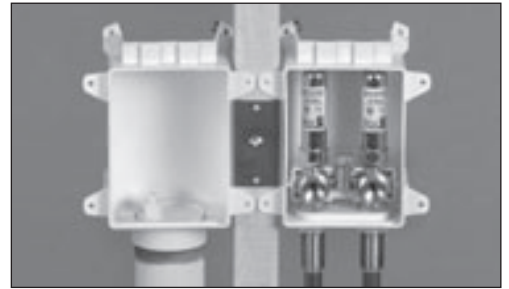

SUPPLY

DRAINAGE

SUPPORT

TESTING

SPECIALTIES

TOOLS

ACCESS

Ox Box™ Outlet Box

Patent Pending

SUPPLY

DRAINAGE

SUPPORT

TESTING

SPECIALTIES

TOOLS

ACCESS

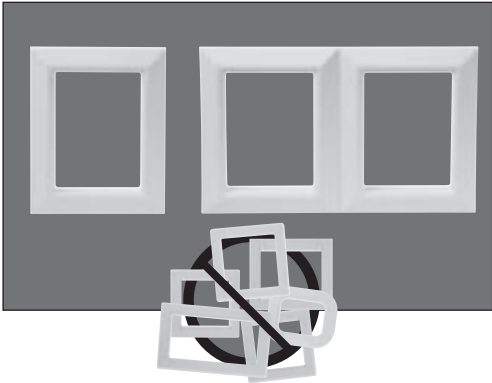
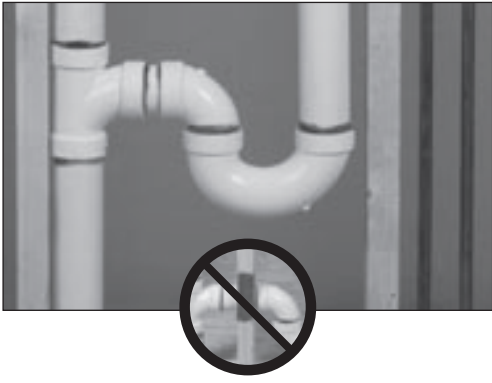
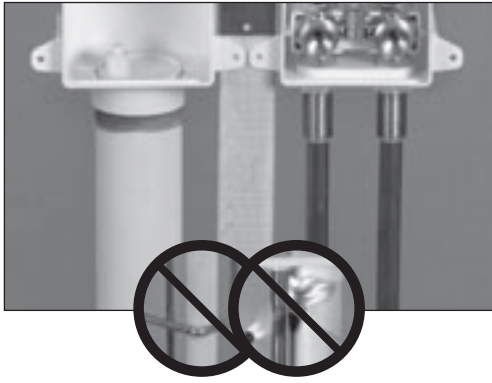
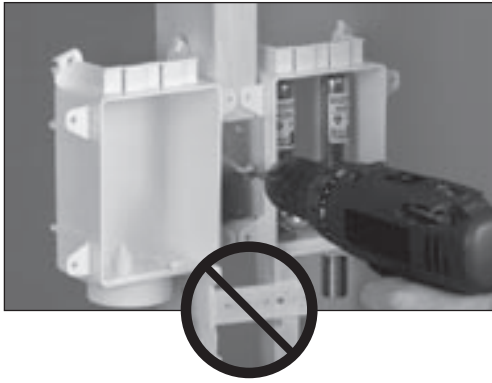

Solid Installations

Durable ABS boxes with a strong steel box clip and bracket stand up to rough job site conditions. Other boxes are made of styrene and have weak plastic tabs.

Separate Stud Bays

Mounting over the stud allows for the supply and drainage lines to be installed in separate stud bays, reducing the number of joints behind the wall and the chance of burning the drain pipe. Over the stud mounting is faster than installing flimsy boxes between the studs.

Drain and Trap Together

With no supply lines to get in the way, both the drain and trap can be installed in the same stud bay. This eliminates the need to drill a hole in the stud and the cost of stud and pipe protection.

One Frame Size

The washing machine and ice maker boxes share the same size frame. Ox Box frames are made from the same tough ABS material as the boxes. The frame can be wallpapered or painted for a custom finish.

Ox Box™

Supply Box

- Choose from high-quality brass ball valves with or without Mini-Rester water hammer arresters
- The Ox Box supply box is available in many connections
 - MIP/female sweat
 - CPVC
 - PEX crimp
 - ProPEX®
 - PEX F2080
 - Kitec PEX
 - Press-fit



Mini-Rester
Water Hammer Arresters
1/4-Turn Ball Valves



1/4-Turn Ball Valves



MIP/FSWT



CPVC



PEX Crimp



ProPEX®



PEX F2080



Kitec PEX



Press-Fit

Drain Box

- The Ox Box drain box includes an integrated test nipple. Pinch and twist the nipple, and the system is ready to test. The water tester is available on p 232



- The drain knockout removes in one piece, and will not fall down the drain



SUPPLY

DRAINAGE

SUPPORT

TESTING

SPECIALTIES

TOOLS

ACCESS

SUPPLY

DRAINAGE

SUPPORT

TESTING

SPECIALTIES

TOOLS

ACCESS

Ox Box™ Washing Machine Outlet Box

Patent Pending

- Boxes mount securely to stud
- Separates supply and drainage systems into two stud bays
- Separate boxes offer flexible layout
- Durable ABS stands up to job site abuse
- Drain knockout is easy to remove with pliers
- Available with two Mini-Rester water hammer arresters

Standard Pack

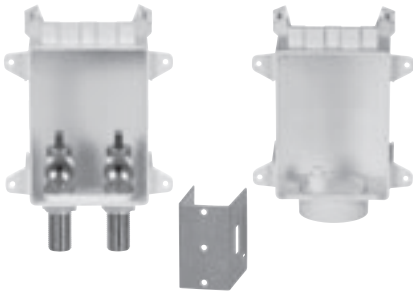

696-2303MF

Rough-in Pack

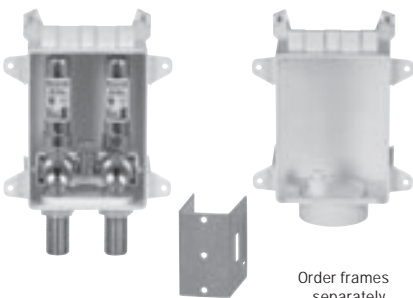

696-2313MR

Debris cover available
Spring 2007

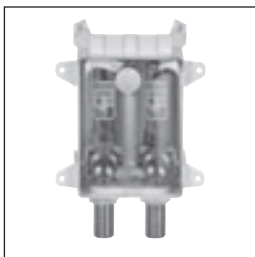

Ox Boxes will soon ship with a plastic debris cover.

Related Products
Frames for Rough-in Packs p 308

Item No.	Shank Connection	Min. Qty.	Case Qty.	List Price
BALL VALVE				
STANDARD PACK				
696-2303MF	MIP/FSWT	10	10	30.95 EA
696-2303CF	CPVC male	10	10	32.75 EA
696-2303XF	PEX crimp F1807	10	10	31.85 EA
696-2303AF	PEX F2080	10	10	34.55 EA
696-2303WF	Wirsbo ProPEX	10	10	32.05 EA
696-2303KF	Kitec PEX	10	10	33.55 EA
696-2303PF	Press-fit	10	10	37.55 EA
ROUGH-IN PACK*				
696-2303MR	MIP/FSWT	10	10	28.95 EA
696-2303CR	CPVC male	10	10	30.75 EA
696-2303XR	PEX crimp F1807	10	10	29.85 EA
696-2303AR	PEX F2080	10	10	32.55 EA
696-2303WR	Wirsbo ProPEX	10	10	30.05 EA
696-2303KR	Kitec PEX	10	10	31.55 EA
ROUGH-IN PACK WITHOUT BOX CLIP AND BAR*				
696-2303MR00	MIP/FSWT	10	10	26.70 EA
696-2303CR00	CPVC male	10	10	28.50 EA
STANDARD PACK BAR-CODED IN DISPLAY BOX				
696-2303MFPK4	MIP/FSWT	4	4	47.74 EA
BALL VALVE WITH MINI-RESTER WATER HAMMER ARRESTER				
STANDARD PACK				
696-2313MF	MIP/FSWT	10	10	56.00 EA
696-2313CF	CPVC male	10	10	57.80 EA
696-2313XF	PEX crimp F1807	10	10	56.90 EA
696-2313AF	PEX F2080	10	10	59.60 EA
696-2313WF	Wirsbo ProPEX	10	10	57.10 EA
696-2313KF	Kitec PEX	10	10	58.60 EA
ROUGH-IN PACK*				
696-2313MR	MIP/FSWT	10	10	54.00 EA
696-2313CR	CPVC male	10	10	55.80 EA
696-2313XR	PEX crimp F1807	10	10	54.90 EA
696-2313AR	PEX F2080	10	10	57.60 EA
696-2313WR	Wirsbo ProPEX	10	10	55.10 EA
696-2313KR	Kitec PEX	10	10	56.60 EA
ROUGH-IN PACK WITH 26" BAR*				
696-2313MR26	MIP/FSWT	10	10	54.50 EA
696-2313CR26	CPVC male	10	10	56.30 EA
696-2313XR26	PEX crimp F1807	10	10	55.40 EA
ROUGH-IN PACK WITHOUT BOX CLIP AND BAR*				
696-2313MR00	MIP/FSWT	10	10	51.75 EA
696-2313CR00	CPVC male	10	10	53.55 EA

*Frames available separately. See p 308.

Ox Box™ Ice Maker Outlet Box

Patent Pending

- Boxes mount securely to stud
- Durable ABS stands up to job site abuse
- Available with Mini-Rester water hammer arrester
- High-quality quarter-turn ball valve

Standard Pack

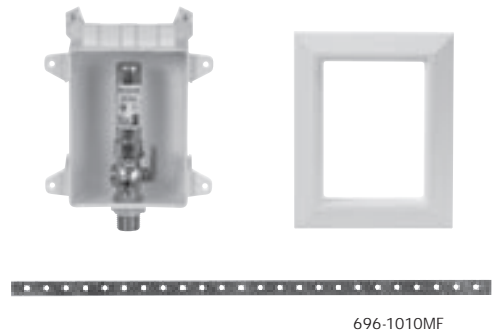

Rough-in Pack

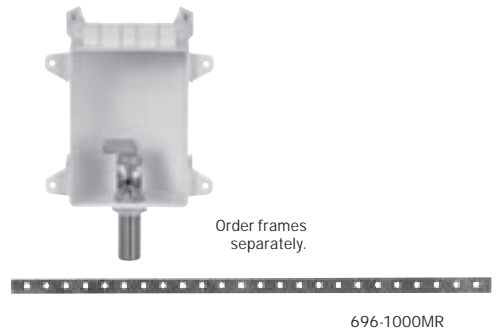

Related Products
Frames for Rough-in Packs p 308

Item No.	Shank Connection	Min. Qty.	Case Qty.	List Price
BALL VALVE				
STANDARD PACK				
696-1000MF	MIP/FSWT	10	10	16.20 EA
696-1000CF	CPVC male	10	10	17.10 EA
696-1000XF	PEX crimp F1807	10	10	16.65 EA
696-1000AF	PEX F2080	10	10	18.00 EA
696-1000WF	Wirsbo ProPEX	10	10	16.75 EA
696-1000KF	Kitec PEX	10	10	17.50 EA
696-1000PF	Press-fit	10	10	19.30 EA
ROUGH-IN PACK*				
696-1000MR	MIP/FSWT	10	10	14.70 EA
696-1000CR	CPVC male	10	10	15.60 EA
696-1000XR	PEX crimp F1807	10	10	15.15 EA
696-1000AR	PEX F2080	10	10	16.50 EA
696-1000WR	Wirsbo ProPEX	10	10	15.25 EA
696-1000KR	Kitec PEX	10	10	16.00 EA
INDIVIDUALLY BAR-CODED IN DISPLAY BOX				
696-1000MFPK4	MIP/FSWT	5	5	22.25 EA
BALL VALVE WITH MINI-RESTER WATER HAMMER ARRESTER				
STANDARD PACK				
696-1010MF	MIP/FSWT	10	10	36.50 EA
696-1010CF	CPVC male	10	10	37.40 EA
696-1010XF	PEX crimp F1807	10	10	36.95 EA
696-1010AF	PEX F2080	10	10	38.30 EA
696-1010WF	Wirsbo ProPEX	10	10	37.05 EA
696-1010KF	Kitec PEX	10	10	37.80 EA
ROUGH-IN PACK*				
696-1010MR	MIP/FSWT	10	10	35.00 EA
696-1010CR	CPVC male	10	10	35.90 EA
696-1010XR	PEX crimp F1807	10	10	35.45 EA
696-1010AR	PEX F2080	10	10	36.80 EA
696-1010WR	Wirsbo ProPEX	10	10	35.55 EA
696-1010KR	Kitec PEX	10	10	36.30 EA
ROUGH-IN PACK WITH 26" BAR*				
696-1010MR26	MIP/FSWT	10	10	35.50 EA
696-1010CR26	CPVC male	10	10	36.40 EA
696-1010XR26	PEX crimp F1807	10	10	35.95 EA

*Frames available separately. See p 308.

Debris cover available
Spring 2007



Ox Boxes will soon ship with a plastic debris cover.

Outlet Boxes

SUPPLY



696-2F

DRAINAGE

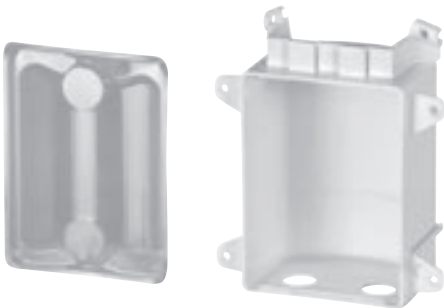

696-2

SUPPORT

TESTING



696-BC

SPECIALTIES



696-PN

TOOLS



696-CF

ACCESS

Ox Box™ Accessories

Frame

- Textured and paintable ABS frame
- Single frame for ice maker application
- Double frame for washing machine application

Outlet Box

- Made from tough ABS
- Installs directly to stud or by bracket
- May be installed with supply from above or below
- One-hole box for ice maker, two-hole box for washing machine
- Washing machine supply box can be placed above, to the left, and to the right of drain box
- Includes debris cover

Box Clip

- Box clip connects two Ox Box outlet boxes
- Secures two boxes to wood or metal studs
- Tabs fold into metal stud for added rigidity

Shank Nut

- Secures valve to outlet box



Secondary Drainage Funnel

- Ideal for adding condensate lines to drain box
- Can be used in conjunction with washing machine drain hose
- Drains 3.5 gpm
- Locks into Ox Box drainage box
- Two-piece design snaps together for fast installation and easy cleaning
- Fingers in top housing hold 1/2"-1" piping firmly in place

Item No.	Description	Min. Qty.	Case Qty.	List Price
FRAME				
696-1F	Single frame	10	10	1.50 EA
696-2F	Double frame	10	10	2.00 EA
OUTLET BOX				
696-1	One-hole supply box	10	10	5.00 EA
696-2	Two-hole supply box	10	10	5.00 EA
696-3	Drain box	10	10	5.00 EA
BOX CLIP				
696-BC	Box clip	10	10	2.00 EA
SHANK NUT				
696-PN	Shank nut	50	50	0.35 EA
SECONDARY DRAINAGE FUNNEL				
696-CF	Secondary drainage funnel	10	10	10.00 EA

Ox Box™ Outlet Box

Installation Comparison

- Installs in half the time of a conventional laundry box
- Constructed of a stronger material and offers the most secure installation on the market
- Offers the most installation options

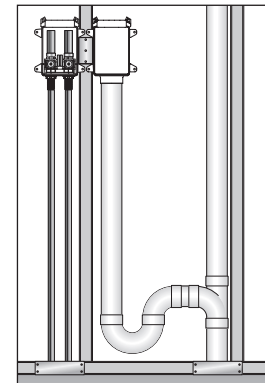

Ox Box

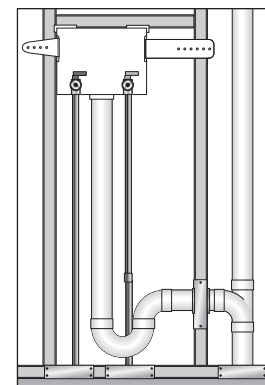

Traditional Box

Installation Step	Installation Time (min)	
	Ox Box	Traditional Box
Measure, drill supply and waste pipe locations	3	5
Set box and secure to rough height	3	5
Measure, cut, set waste pipe to box rough height	1	3
Measure, cut, connect supply lines to box	3	5
Set pipe protections to code standard	2	4
Set additional brackets	—	4
Total Average Time	12 minutes	26 minutes

Try it for yourself. Use the form below to compare your results to ours and see for yourself the time and money the Ox Box can save you.

Installation Step	Time	×	Rate	=	Cost
Measure and drill the supply and waste pipe locations		×		=	\$
Set the box and secure to studs at rough-in height		×		=	\$
Measure, cut, and set waste pipe to box at rough-in height		×		=	\$
Measure, cut, and connect supply lines to box		×		=	\$
Install additional support brackets to secure box if needed		×		=	\$
Install pipe protection per code		×		=	\$
Material cost of additional supply fittings used					\$
Material cost of additional support brackets used					\$
Material cost of pipe protection used					\$
Total					\$

SUPPLY

DRAINAGE

SUPPORT

TESTING

SPECIALTIES

TOOLS

ACCESS



970-112



970-117



970-214

Access Panel

One Piece

- Provides economical access to pressure and drainage plumbing, pipes, and wiring
- Surface allows for painting and wallpapering
- 1/8" thick
- Four countersunk holes

Two Piece

- Provides economical access to pressure and drainage plumbing, pipes, and wiring
- Surface allows for painting and wallpapering

Item No.	Dimensions		Material	Min. Qty.	Case Qty.	List Price
	Outside	Inside Panel				
ONE PIECE						
970-112	12" x 12"	—	ABS	20	20	5.05 EA
970-117	17" x 17"	—	polystyrene	12	12	8.51 EA
TWO PIECE						
970-208	11" x 11"	7 1/2" x 7 1/2"	polystyrene	12	12	18.90 EA
970-214	17" x 17"	13 1/2" x 13 1/2"	polystyrene	12	12	23.70 EA

Appendix

Alphabetical Index
Numerical Index
Try Me Pack Index
Reference Data
Representatives
Order Form

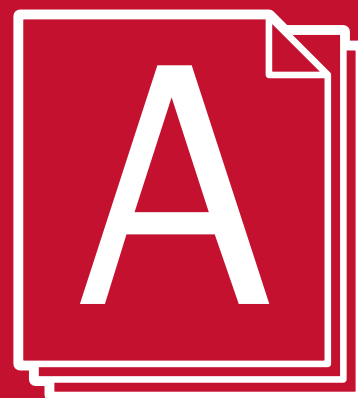

Appendix

SUPPLY

ALPHABETICAL INDEX
313-316 Index

NUMERICAL INDEX
317-344 Index

TRY ME PACKS
317-344 Index

REFERENCE DATA
348-349 Dimensional Information

DRAINAGE

REPRESENTATIVES
350 Our Representatives
351 Territory Map

ORDER FORM
352 Official Sioux Chief Order Form

SUPPORT

TESTING

SPECIALTIES

TOOLS

ACCESS

A

Abrasive mesh 286
 Access panel
 One piece 312
 Two piece 312
 Acid brush 287
 Adapter
 CPVC 54–56
 PEX elbow 43–44
 PEX straight 41–43
 PEX straight 41–43
 PEX tee 44
 PVC 60
 Add-A-Line 27–28
 Aerator adapter 244
 All-thread rod 204
 American standard
 Actuating unit 263
 Flush valve disc 264
 Flush valve seal 264
 Anchor screw kit 202
 Auto vent anti-siphon 256
 Atlas drain 161

B

Backup float valve 187
 Backwater device 159
 Backwater valve 173
 Ball valve, brass
 CPVC 56
 PEX 46
 PVC 60
 Sweat 29
 Gas 272
 Ball valve, thermoplastic
 CPVC 57
 PVC 61
 Ball valve
 PEX 46
 PVC 60
 Sweat 29
 Ball valve, double union PVC 61
 Ballcock adapter, PEX 45
 Ballcock, anti-siphon 268
 Ballcock repair kits 269
 Basin gasket 255
 Basin strainer 255
 Beam clamp 204
 Bell hanger 201
 Bell trap drain 164
 Bin box corrugated 297
 Bits for vandal-resistant screws 186
 Boiler drain, brass
 CPVC 57
 Sweat 30
 CPVC 57
 Box clip 310
 Box polypro parts 297
 Brush
 Acid 287
 Fitting 285
 Pipe dope/cement 287
 Tube O.D. 286
 Bucket, multi-purpose square 297
 Bullet
 PEX 35
 Sweat 13–15

C

Cable tie 202
 Carrier bracket 217
 Cement stop leak 296
 Center outlet waste 251
 Chase bracket 217
 Chieftain EII Clamp 221
 Cleanout, adjustable
 ABS/PVC connection 146
 Cast iron MIP thread 145
 Cast iron no-hub 147
 Cast iron push-joint 148
 Finish Line 139–141
 PVC MIP thread 142–144
 Cleanout bushing 152
 Cleanout cover 150
 Cleanout cover accessories 152
 Cleanout cover kit 151
 Clevis hanger 203
 Closet bolt cover cap 259
 Closet bolt
 Plumb Perfect 258
 Snap-It 259
 Solid brass 259
 Closet bowl cushion 263
 Closet flange
 Cast iron 168
 Open 167
 Closet flange floor support 270
 Closet flange ring
 Brass 168
 Ringer 169
 Copper cleaning pad 287
 Copper Star 220
 Coupling
 PEX 39
 Covers for cleanouts 184–185
 CPVC mechanical test plug 227
 Crayon, lumber 299
 Crimp ring
 PEX 34
 Crimp ring removal tool 290
 Crimp tools for PEX & PB crimp rings 289

D

Deburring tool 294
 Dielectric connector 23
 Dishwasher air gap 256
 Dishwasher drain hose 257
 Dishwasher elbow, PEX 45
 Dishwasher tailpiece 248–249
 Display hook 300
 Disposal parts 257
 Disposal waste kit 251
 Double stub out elbow, sweat 16
 Double union ball valve, PVC 61
 Drain adapter
 Fitting socket 179
 Flashing 180
 No-hub 180
 Push-joint 179
 Slab-grab 179
 Standard 178
 Drain connector kit 257
 Drip-free 253
 Drive hook 200
 Drop-kick 168
 Dry seal pipe collar 238

Duct tape 295
 Dust mask 300
 DWV connector, brass 254
 DWV hanger 209
 DWV slip joint adapter 254

E

Edge 214
 Elbow adapter
 PEX 43–44
 Elbow, PEX 40
 Eljer touch-flush 266
 End outlet waste 251
 Extension tube 250

F

Fat Max 124
 Stainless steel 126
 Accessories 126
 Options 125
 Faucet adapter, PEX 45
 Faucet aerator 244
 Faucet handle puller 291
 Faucet hole cover 239
 Faucet nut wrench 283
 Faucet seat wrench 284
 Faucet stem key 290
 Finish Line
 Cleanouts 139–141
 Flashing drains 127–130
 On-grade drains 110–112
 Fitting brushes 285
 Fitting, PB 48
 Flame pad, safe-flame 299
 Flappers 265
 Flaring tools 293
 Flashing drain adapter 180
 Flashing drain
 Cast iron no-hub 133
 Cast iron push-joint 134
 Sch. 40 hub 131–132
 Float ball rod 268
 Floor & ceiling plate 237
 Floor drain
 2" × 3" Quad Drain 160
 3" × 4" Quad Drain 160
 Atlas Drain 161
 Cast iron no-hub on-grade 120
 General purpose 162
 On-grade sch. 40 hub 118–119
 Sch. 40 hub on-grade 118–119
 Weld one 159
 Floor drain, adjustable
 Cast iron MIP thread 117
 PVC MIP thread 113–116
 Floor sink, cast iron square 121
 Flush plug
 Brass 177
 PVC spanner 178
 Slotted polypro 176
 Flush valve 263
 Flush valve balls 266
 Frame for outlet box 310
 Full flush 167
 Full-slip repair couplings 25

G

- Gas ball valve 272
- Gas test gauge 231
- Gloves
 - Disposable latex 298
 - Work 298
- Grabber, flexible 292
- Graphic department 1–352
- Grid Iron 219
- Grip Tip 229
- Gripper 163

H

- Hacksaw, mini 277
- Hand Tite 226
- Handy Pump 232
- Hanger strap 209
- Hangs Tuff Jr. 205
- Hangs Tuff 206
- HearthMaster
 - Gas ball valve 272
 - Log lighter bar 271
 - Log lighter kits 271
- Heat trap loop, sweat 23
- Heating coil loop connector 82
- Hex key set 293
- High-pressure hand pump 232
- Hose clamp 256
- Hose washer 244
- Hydra-Rester 98
- Hydronic manifolds
 - ½" ComPEX branches 91
 - ½" Male sweat branches 89
 - ½" MIP branches 90
 - ½" MIP/female sweat branches 90
 - ½" PEX F1817 branches 90
 - ½" R20 branches 91
 - Endpiece 91

I

- Ice maker outlet box 309
- Ice maker valve, PEX 47
- Inflatable test plug 228
- Inflatable test tee plug 228
- Inside pipe cutter 277
- Inspection mirror 292
- Internal nipple wrench set 284

J

- JackRabbit 157

K

- Kitchen hose 245
- Knife, utility 278
- Knockout test plug & cap 230

L

- Lavatory branch tailpiece 248
- Lavatory drain 255
- Levels 293
- Little Max 121
- Log lighter
 - Accessories 273
 - Bar 271
 - Kits 271
- Long branch 247
- Lubricant, silicone 294
- Lumber crayon 299

M

- Major Tee 248
- Male adapter, full-slip 26–27
- Mansfield flush valve gasket 264
- Match holder 292
- Measuring tape, locking 294
- Mechanical test device 227
- Mechanical test plug, CPVC 227
- Mega-Rester 100
- Metal stud punch 290
- Milford hanger 205
- Mini hacksaw 277
- Mini-Rester 94–97
- Mirror 292
- Moen cartridge puller 290

N

- Natick hanger 205
- Nipples copper 26
- No-putty gasket 253

O

- Oakum 296
- Offset ratchet box wrench 282
- Offset riser fitting sweat 20
- Offset tub spout elbow sweat 18
- On-grade floor drain
 - Cast iron no-hub 120
 - Sch. 40 hub 118–119
- O-ring pick 292
- Outlet box 310
 - Ice maker 309
 - Washing machine 308
- Ox Box 305–308
 - Ice maker outlet box 309
 - Washing machine outlet box 308
- Ox Box accessories 310

P

- P.O. plug wrench 283
- Padlock 194
- Peg board display hook 300
- PEX crimp ring 34
- Philadelphia style vent cap 165
- Pick, o-ring 292
- Pick-Up Talon 193
- Pipe bore adapter 186
- Pipe dope/cement brush 287
- Pipe drain inside 161
- Pipe Eye Suspension Bracket 216
- Pipe Eye 191
- Pipe repair clamp 245
- Pipe Titan 218
- Pipe wrench
 - Heavy duty 281
 - Power grip ratcheting 281
- Pittsburgh style drain 165
- Plated stub out sleeves 26
- Pliers slip joint 281
- Plumb Perfect 258
- Plunger 296
- Poly sink tailpiece 250
- Poly tank float ball 268
- Polybutylene
 - Fittings 48
 - Tees 48
- Positioning bracket 217

Potable manifolds

- ½" PEX branches 85
- ½" MIP branches 88
- ½" MIP/FSWT ball valve branches 88
- ½" PEX ball valve branches 85
- ½" PEX branches 86
- ¾" female sweat branches 87
- Male sweat branches 87
- Mixed PEX branches 87
- Power Bar 212–213
- Pre-cut copper nipples 26
- Prime Berfect 103
- PTFE packing rope 295
- PTFE pipe thread tape 295
- Push-Tite 166

Q

- Quad Drain
 - 2" x 3" 160
 - 3" x 4" 160
- Quick Plug 230
- Quick Spacer 169

R

- Raise-A-Ring 169
- Ratchet tube cutter 278
- Repair couplings 25
- Replace-A-Valve 25
- Replace-It 163
- Ringer 169
- Roof drain
 - 867 series 135
 - 868 series ABS/PVC 136
 - 868 series cast iron 137
- Rope, PTFE packing 295
- Rubber ballcock washer 269

S

- Saddle-Up 216
- Sand cloth 286
- Save-A-Flange 269
- Saw
 - Sawhorse 277
 - Wire cable 278
- Sawhorse 277
- Screw extractor set 291
- Screwdriver, 6-in-1 291
- Screws bits for vandal-resistant 186
- Scrub Clean 300
- Secondary drainage funnel for outlet box 310
- Secure-All 215
- Shallow escutcheon 237
- Shank nut 310
- Shield plate 222
- Shoe covers disposable 300
- Short-N-Swivel 54
- Shower arm and accessories 240
- Shower head 240
- Shower module drain
 - ABS/PVC 156
 - ABS/PVC offset 158
 - JackRabbit 157
 - No-caulk 157
 - Push-joint/solvent weld 158
- Shower riser fitting, sweat 19
- Shower wallnut 241
- Shower-Up
 - For copper FIP connection 67
 - For copper male sweat connection 65

- Shower-Up
 For copper MIP connection 66
 For CPVC FIP connection 75
 For CPVC MIP connection 74
 For CPVC sweat connection 73
 For PEX FIP connection 71
 For PEX MIP connection 70
 For PEX sweat connection 69
- Side beam connector 204
- Sidewinder 220
- Silicone lubricant 294
- Sillcock
 CPVC 57
 Sweat 30
- Sillcock, frost-proof anti-siphon
 PEX 47
 Sweat 31
 Replacement parts 32
- Sink plug, industrial 254
- Sink tailpiece brass 249
- Sioux strap 194
- Slider 214
- Slip joint extension tube 249
- Slip joint pliers 281
- Slip nut 252
- Sloan vacuum breaker 266
- Smart Cap 260
- Smart Saddle 187
- Snap One 236
- Snap-It 259
- Socket wrench set 283
- Solder strap 220
- Spin Off 279
- Split ring hanger 203
- Spud gasket 263
- Square Max 122
- Square Max accessories 123
- Square Max options 123
- Square O strap 220
- St. Louis style drain 165
- Stainless steel Fat Max 126
- Stick-Em Up 208
- Stop & waste valve, brass
 CPVC 57
 PEX 46
 Sweat 29
- Stop leak cement 296
- Straight adapter, PEX 41–43
- Strainer 184
 Cast iron 184
 For drains 181–183
 For roof drains 183
 Gripper 163
 Replace-It 163
- Strainer/vent cap
 For drains 183
- Strap wrench 282
- Stub Air
 PEX 35
 Sweat 18
- Stub out bracket 215
 With stud guard 216
- Stub out elbow
 CPVC 50
 PEX 34
 Sweat 15–16
- Stub out elbow, double
 Sweat 16
- Stud guard 222
- Stud punch 290
- Stud shoe 221
- Supply step washer 244
- Supply stop
 PEX 47
 Sweat 32
- Supply tube 243
- Supply tube extension 243
- Support bracket 214
- Suspension clamp 197
- Suspensulator 191
- T**
- Tailpiece & slip washer 252
- Tank ball and handle set 266
- Tank ball brass wire 268
- Tank bolt set 260
- Tank bowl kits 261
- Tank handles 267
- Tankless water heater 82
- Tank-to-bowl gaskets 262
- Tape
 Duct 295
 PTFE pipe thread 295
- Tape measure, locking 294
- Tee, adapter PEX 44
- Tee
 Add-A-Line 27–28
 PEX 40
 PB 48
- Termination fitting, sweat 24
- Test assemblies 231
 Test cap, knockout 230
- Test cap, flexible PVC 230
- Test plug
 Cleanout 225
 Inflatable 228
 Knockout 230
 Mechanical 225
 PEX 41
 Pneumatic 226
- Test tee plug
 Inflatable 228
 Mechanical (ttmtp) 227
- Test Titan
 Cleanout test plug 225
 Mechanical test plug 225
 Pneumatic test plug 226
- Threaded tube–TBE brass 249
- Tie-down strap 299
- TKO 165
- Tomahawk 208
- Top plate connector 204
- TouchDown II 196
- TouchDown II with Beam Clamp 197
- TouchDown II with Strut Clamp 197
- TouchDown 195
- TouchDown with Beam Clamp 197
- Trap primer accessories 104
- Trap-Ease 104
- Traps 250
- Trim Tite 235
- Tub face plate 240
- Tub overflow gasket 255
- Tub spout 239
- Tub spout elbow
 Sweat 17
 Sweat offset 18
- Tub spout escutcheon 238
- Tub/shower elbow
 CPVC 51
 PEX 36
 Sweat 20
- Tub/shower pressure connector
 CPVC 51
 PEX 36
 Sweat 19
- Tub valve escutcheon/nipple 239
- Tube clamp 198
- Tube cutter 279
 Plastic 278
 Ratchet 278
 Spin Off 279
- Tube insulator 198
- Tube O.D. brush 286
- Tube strap
 2-hole 199
 Nail 202
- Tube Talon 192
- Twin Talon 192
- U**
- Universal Slider Bracket 210–211
- Urinal flange kit 170
- Utility knife 278
- V**
- Vacu-Rester 102
- Vacuum breaker 32
- Valved service loop PEX 39
- Vent cap
 Philadelphia style 165
 PVC 164
- Vinyl-coated steel clamp with screw 198
- W**
- Wal-Let
 CPVC 54
 Sweat 24
- Washing machine outlet box 308
- Water hammer arrester
 Commercial 98
 Industrial 100
 Residential 95
 Vacuum-breaker 102
- Water heater connector
 CPVC 52–53
 PEX 37–38
 Sweat 20–22
- Water heater connector kits
 Copper system 76
 CPVC system 80
 PEX system 78
 Tankless 82
- Water heater element wrench 284
- Water heater stub out loop
 PEX 39
 Sweat 23
- Water service connectors, sweat 24
- Water tester 232
- Wedge-It 270
- Weld One 159
- Wet-proof cloth 286
- Wire cable saw 278
- Wire pipe hook 200–201
- WOG pressure gauge 231
- Work gloves 298

Alphabetical Index

CATALOG 2007

Wrench

- Faucet nut 283
- Faucet seat 284
- Heavy duty pipe 281
- Internal nipple set 284
- Offset ratchet box 282
- P.O. plug 283
- Power grip ratcheting pipe 281
- Socket set 283
- Strap 282
- Telescopic basin 282
- Water heater element 284

Z

- ZipStick 207
- ZipStrap 207

ALPHABETICAL INDEX

ALPHABETICAL INDEX

ALPHABETICAL INDEX

ALPHABETICAL INDEX

Item No.	Page No.	Min Qty	Case Qty	List Price	UPC Bar-Coded	UPC 5-Digit 739236	Weight (lbs)	Item No.	Page No.	Min Qty	Case Qty	List Price	UPC Bar-Coded	UPC 5-Digit 739236	Weight (lbs)
104-22	29	10	120	8.75		50003	0.3650	118X204P	47	2	2	28.20		51008	1.2019
104-23	29	10	90	14.15		50004	0.7830	118X206P	47	2	40	28.44		51009	1.2869
104-24	29	6	60	21.50		50005	1.1790	118X208P	47	2	40	30.12		48908	1.3759
105-22	29	10	120	13.10		50006	0.4250	118X210P	47	2	40	30.33		51010	1.5801
105-23	29	10	60	20.28		50007	0.7980	118X212P	47	2	40	37.32		51011	1.6431
105-24	29	6	36	29.82		50008	1.2020	119-204	31	1	25	28.19		51881	1.5395
106-12	61	10	100	2.77		80805	0.0000	119-206	31	1	25	28.38		51882	1.5454
106-13	61	10	100	3.75		80807	0.0000	119-208	31	1	25	30.06		51883	1.7200
106-14	61	5	50	5.20		51925	0.0000	119-210	31	1	25	33.83		51884	1.7196
106-15	61	5	50	7.43		51924	0.0000	119-210CPK	31	5	5	40.63	✓	51885	0.3660
106-16	61	4	24	10.42		51923	0.0000	119-210PK	31	5	5	39.38	✓	51886	1.6382
106-17	61	4	24	12.92		51922	0.0000	119-212	31	1	25	37.13		51887	1.8096
106-22	61	10	100	2.68		51921	0.0000	119X204P	47	2	2	32.38		51888	1.4212
106-23	61	10	100	3.56		51920	0.0000	119X206P	47	2	2	32.63		51889	1.4844
106-24	61	5	50	5.01		51919	0.0000	119X208P	47	1	25	34.56		51890	1.5521
106-25	61	5	50	7.26		51918	0.0000	119X210P	47	1	25	39.69		51891	1.6402
106-26	61	4	24	10.08		51917	0.0000	119X212P	47	1	25	42.70		51892	1.7020
106-27	61	4	24	12.65		51916	0.0000	200-062	247	25	25	9.23		50047	0.3340
106-C22	57	10	100	5.60		51915	0.0000	200-064	247	25	25	9.87		50048	0.3840
106-C23	57	10	100	7.50		51914	0.0000	200-066	247	25	25	12.68		50049	0.3840
106-C24	57	10	100	11.99		51913	0.0000	200-082	247	25	25	10.21		50050	0.3923
107-12	61	12	72	9.08		51912	0.0000	200-084	247	25	25	11.04		50051	0.4422
107-13	61	12	60	11.99		51911	0.0000	200-090	104	25	25	9.45		10500	0.4422
107-14	61	5	45	17.40		51910	0.0000	200-092	104	25	25	10.45		10501	0.4422
107-15	61	4	24	26.06		51909	0.0000	200-102	247	25	25	11.28		50052	0.4488
107-16	61	4	16	34.72		51908	0.0000	200-104	247	25	25	11.91		50053	0.4989
107-17	61	4	12	46.85		51907	0.0000	200-122	247	25	25	12.19		50054	0.5056
108-12	274	12	144	7.98		51016	0.3700	200-124	247	25	25	12.83		51896	0.5556
108-12PK	274	12	12	8.66		80802	0.3911	200-124PK	247	25	25	12.92	✓	50055	0.5759
108-13	274	12	144	10.60		51017	0.5500	204-068	247	25	25	12.63		50038	0.8168
108-13PK	274	12	12	11.67		80804	0.5773	206-064	247	25	25	10.67		50039	0.4740
108-14	274	6	60	21.73		80806	0.8780	206-066	247	25	25	13.67		50058	0.4640
111-22	29	10	100	7.42		50009	0.4900	206-084	247	25	25	11.50		50059	0.6946
111-23	29	10	100	7.92		50010	0.5950	210-064	248	25	25	10.48		50060	0.3601
113-32	29	10	10	6.89		50014	0.5230	210-066	248	25	25	13.08		50061	0.3601
113-33	29	10	100	7.39		50015	0.5520	210-084	248	25	25	11.25		50062	0.4185
113-C32	57	25	25	10.24		40001	0.5959	210-086	248	25	25	14.42		50063	0.4219
116-22	30	10	10	11.82		50016	0.5540	210-122	248	25	25	12.60		50064	0.4817
116-32	30	5	50	12.22		50017	0.4700	213-060	248	25	25	9.19		50483	0.3166
116-C22	57	25	25	15.56		40002	0.6269	213-061	248	25	25	10.39		50955	0.4118
116-C223E	57	25	25	16.25		40003	0.6661	213-067	248	25	25	11.91		50067	0.3378
116X22	46	25	25	14.45		40004	1.3889	213-068	248	25	25	12.24		50957	0.3166
117-03	32	20	240	6.25		50018	0.2340	213-069	248	25	25	9.33		50956	0.2911
117-22	30	10	100	8.25		50019	0.5690	213-090	104	25	25	8.45		10502	0.3483
117-C22	57	25	25	11.91		40005	0.6455	213-092	104	25	25	9.35		10503	0.3483
117-C223E	57	25	25	12.53		40027	0.6811	215-064	248	25	25	10.28		50070	0.3503
118-01	32	12	12	1.76		50000	0.0770	215-066	248	25	25	13.19		50071	0.3503
118-02	32	12	12	0.10		50021	0.0070	216-084	248	25	25	11.67		50072	0.6682
118-03	32	1	1	0.80		50022	0.0130	216-086	248	25	25	14.71		50073	0.6582
118-04	32	12	12	0.30		50023	0.0060	220-040	249	50	50	3.19		50074	0.1270
118-05	32	12	12	0.10		50667	0.0010	220-048	249	48	48	3.52		50075	0.1290
118-06	32	1	1	0.42		50034	0.0020	220-060	249	50	50	4.89		52031	0.1846
118-07	32	1	1	2.89		50044	0.0140	220-068	249	24	24	3.51		50076	0.1900
118-08	32	1	1	2.04		50027	0.0270	220-088	249	24	24	4.73		50077	0.2480
118-0904	32	1	1	7.50		50028	0.1160	220-120	249	25	25	6.84		50078	0.3692
118-0906	32	1	1	8.00		50029	0.1400	220-128	249	24	24	6.29		50079	0.3920
118-0908	32	1	1	8.50		50030	0.1580	220-168	249	24	24	8.67		50080	0.4960
118-0910	32	1	1	9.00		50031	0.1760	223-128	249	24	24	9.60		50040	0.4400
118-0912	32	1	1	9.50		50032	0.2060	224-128	249	24	24	11.35		50041	0.5280
118-204	31	2	40	24.60		51000	1.0500	225-068	249	24	24	5.54		50042	0.2400
118-206	31	2	40	24.75		51001	1.1350	225-088	249	24	24	6.06		50043	0.2880
118-208	31	2	40	26.25		51002	1.2240	225-128	249	24	24	8.29		50085	0.3920
118-210	31	2	40	29.26		51004	1.2960	226-068	249	24	24	6.11		50086	0.2720
118-210CPK	31	5	5	37.35	✓	48916	1.6320	226-088	249	24	24	7.39		50087	0.3440
118-210PK	31	5	5	35.10	✓	48917	1.7020	226-128	249	24	24	10.00		50088	0.4640
118-212	31	2	40	32.40		51007	1.3590	230-040	250	25	25	0.78		50089	0.0640

A 10% surcharge will be applied to any item NOT purchased in multiples of the stated Minimum Quantity, except on drop ship orders. Items that are bold in the Min Qty column may NEVER be broken.

Numerical Index

CATALOG 2007

NUMERICAL INDEX

NUMERICAL INDEX

NUMERICAL INDEX

NUMERICAL INDEX

NUMERICAL INDEX

Item No.	Page No.	Min Qty	Case Qty	List Price	UPC Bar-Coded	UPC 5-Digit 739236	Weight (lbs)
230-040B	250	25	25	0.73		50090	0.0680
230-060	250	25	25	0.73		50035	0.0880
230-080	250	25	25	1.01		50045	0.1120
230-120	250	25	25	1.62		50046	0.1440
230-160	250	25	25	2.79		50094	0.2320
230-160B	250	25	25	2.79		50095	0.2160
231-2	249	25	25	2.49		50096	0.1520
231-3	249	25	25	2.50		50097	0.1520
232-2	249	25	25	2.76		50098	0.1680
232-3	249	25	25	2.76		50099	0.1680
232-3B	249	25	25	2.76		50100	0.1680
234-10	250	25	25	2.48		50101	0.3760
234-10B	250	25	25	2.48		50102	0.3440
234-2	250	25	25	7.37		50103	0.6904
234-5	250	25	25	3.36		50104	0.2640
234-5B	250	25	25	3.36		50105	0.2560
234-OP	230	25	100	0.70		30000	0.0336
236-060	250	25	25	1.63		50106	0.3120
236-080	250	25	25	1.77		50107	0.1440
236-120	250	25	25	2.02		50108	0.1920
236-160	250	25	25	3.55		50109	0.3120
236-160B	250	25	25	3.55		50110	0.3120
238-120	250	25	25	2.57		50111	0.2240
238-160	250	25	25	3.04		50112	0.3040
239	256	50	50	3.98		51899	0.0940
239PK2	256	10	10	4.55	✓	30200	0.1254
242-10	246	1	10	9.64	✓	50114	0.5589
242-20	246	1	100	1.50	✓	50115	0.0709
242-20102	246	1	10	10.08	✓	50116	0.6129
242-20106	246	1	10	5.50	✓	50117	0.1668
242-20116	246	1	25	1.50	✓	50118	0.0787
242-25	246	1	10	5.26	✓	50119	0.1616
249	256	25	25	8.92		50120	0.2800
249-20135	256	1	10	4.75	✓	50121	0.3246
251-550	251	25	25	6.76		50122	0.4640
251-550B	251	25	25	6.92		50123	0.4920
253-550	251	25	25	5.50		50124	0.4240
253-550B	251	25	25	5.46		50125	0.4280
253-552	251	15	15	7.08		50126	0.4530
253-552B	251	15	15	7.07		50127	0.4530
253-553	251	15	15	7.08		50128	0.5440
257-550	251	25	25	6.55		50129	0.5840
257-550B	251	25	25	6.48		50130	0.5440
258-160	251	25	25	7.07		50131	0.6240
270-6	254	25	25	10.84		50132	0.4899
272-6	254	25	25	11.26		50134	0.5219
274-5	254	10	100	7.81		50135	0.0626
274-6	254	10	100	5.67		50136	0.0689
274-7	254	10	100	5.73		50137	0.0729
280-100	243	100	2000	0.28		50138	0.0038
280-12	243	100	100	3.10		50139	0.1260
280-20	243	100	100	4.67		50140	0.2020
280-36	243	50	50	8.23		50141	0.3680
283-12	243	50	50	3.86		50142	0.1320
283-20	243	50	50	5.44		50143	0.2300
285-100	243	100	10000	0.10		50144	0.0011
285-12	243	100	100	0.94		50145	0.0400
285-20	243	100	100	1.18		50146	0.0600
285-30	243	100	100	1.47		50147	0.0880
285-36	243	100	100	1.78		50148	0.1140
287-12	243	100	100	0.98		50149	0.0420
287-20	243	100	100	1.22		50150	0.0600
289-12	243	100	100	1.81		50151	0.1110
289-20	243	100	100	2.85		50152	0.1864
290-20180	257	5	25	0.75		50153	0.0350
290-20181	257	1	25	1.88	✓	50154	0.1264

A 10% surcharge will be applied to any item NOT purchased in multiples of the stated Minimum Quantity, except on drop ship orders. Items that are bold in the Min Qty column may NEVER be broken.

Item No.	Page No.	Min Qty	Case Qty	List Price	UPC Bar-Coded	UPC 5-Digit 739236	Weight (lbs)
290-20185	257	1	12	3.05		50155	0.1813
290-20200	254	1	10	17.49	✓	50156	0.8028
290-20202	254	5	25	3.72		50157	0.1210
290-20300	253	25	300	0.48		50158	0.0069
290-20301	253	100	1000	0.44		50159	0.0068
290-20310	253	25	300	0.48		50958	0.0069
290-20311	253	100	1000	0.44		50161	0.0068
290-20312	253	10	100	0.61		50162	0.0133
290-20313	253	50	500	0.54		50163	0.0126
290-20320	253	100	1000	0.60		50164	0.0060
290-20320PK2	253	1	12	2.70	✓	56615	0.0513
290-20320PK4	253	1	1	63.97	✓	51018	0.9309
290-20322	253	100	1000	0.60		50165	0.0020
290-20322PK4	253	1	1	128.38	✓	51020	0.9506
290-20324	253	100	1000	0.60		50166	0.0040
290-20324PK2	253	1	12	2.70	✓	56617	0.0414
290-20324PK4	253	1	1	128.38	✓	51022	1.3506
290-20379	252	25	25	2.95		50167	0.0777
290-20380	253	25	300	0.48		50168	0.0069
290-20381	253	100	1000	0.44		50169	0.0068
290-20400	32	1	20	7.08	✓	50170	0.2647
290-20480	244	50	500	0.32		50171	0.0165
290-20482	244	50	500	0.45		50172	0.0245
290-20514	255	1	12	19.55	✓	50174	0.8759
290-20525	255	3	120	1.19		50179	0.0213
290-20526	255	3	120	1.45		50180	0.0223
290-20560	255	5	25	0.74		50192	0.0422
290-20562	255	5	25	0.72		50193	0.0680
290-20564	255	5	25	1.18		50194	0.0580
290-20566	255	5	25	0.74		50195	0.0392
290-20568	255	5	25	0.75		50196	0.0560
290-21100	244	6	48	2.10		50197	0.0542
290-21104	244	6	48	2.10		50199	0.0442
290-21110	244	5	250	3.05		50201	0.0844
291-30125	245	1	1	19.32		50223	0.8006
291-30126	245	1	1	36.85		50224	1.4683
291-30225	245	1	1	19.93		50237	1.0209
291-30226	245	1	1	31.51		50238	1.3316
291-30380	245	1	10	24.75		50265	0.5450
291-30400	295	24	240	1.66		50266	0.0281
291-30500	244	12	144	0.15		50283	0.0030
291-60230	239	1	24	5.60		50297	0.5081
300-12	277	12	12	15.32		50012	0.4982
300-12B	277	1	25	12.25		50013	0.3401
300-20	277	4	4	36.24		50020	1.0800
300-20B	277	6	6	23.25		50417	1.1031
301-061	277	5	100	0.68		50037	0.0396
301-062	277	10	10	11.33		50026	0.3760
301-065	277	20	20	2.89		50036	0.1700
304-06	294	1	24	9.90	✓	52043	0.0000
304-08	278	6	60	16.70		51015	0.2760
304-09PK1	279	1	1	19.95	✓	50525	0.1952
304-1	278	1	50	7.05		50057	0.0600
304-10	278	1	36	82.00	✓	50423	0.8360
304-15	278	1	12	40.25	✓	50424	0.1526
304-20	279	1	100	6.50	✓	56646	0.0000
304-25	279	1	10	25.42		56620	0.0000
304-30	279	1	10	9.95	✓	55621	0.0000
304-32	279	1	20	2.95	✓	55622	0.0000
304-5	278	10	50	7.05		51893	0.0649
304-6B	294	1	50	9.75	✓	55623	0.0000
304-9	279	1	25	5.75	✓	56618	0.0353
305-10	289	1	12	214.04	✓	50081	3.7750
305-100PK1	289	1	10	55.00		52042	3.7750
305-10CPK1	289	1	1	180.00	✓	50505	3.0710
305-20	289	1	12	214.04	✓	50082	3.5830

Item No.	Page No.	Min Qty	Case Qty	List Price	UPC Bar-Coded	UPC 5-Digit 739236	Weight (lbs)	Item No.	Page No.	Min Qty	Case Qty	List Price	UPC Bar-Coded	UPC 5-Digit 739236	Weight (lbs)
305-23	289	1	1	212.50	✓	50011	4.6000	360-30PK1	231	1	10	8.50	✓	51853	0.3051
305-23CKIT	289	1	16	269.99	✓	50513	6.1855	360-60PK1	231	1	10	8.50	✓	51856	0.2851
305-23CPK1	289	1	1	200.00	✓	50508	3.5000	390-50105	278	1	25	6.62	✓	50024	0.0517
305-30	289	1	12	214.04	✓	50083	3.7250	390-50110	292	1	25	6.86	✓	50460	0.0818
305-30CPK1	289	1	10	180.00	✓	52040	3.1691	390-50115	292	1	24	14.75	✓	50461	0.1860
305-40	289	1	12	260.00	✓	50084	3.8000	390-50117	292	1	25	4.42	✓	50462	0.2227
305-521	290	1	1	474.49	✓	50429	6.2000	390-50120	284	1	10	38.75	✓	50463	1.0747
305-91	289	1	20	253.50	✓	50091	2.1930	390-50122	284	1	100	13.66	✓	50464	0.3223
305-92	289	1	20	253.50	✓	50092	2.2150	390-50126	291	1	25	18.22	✓	50465	0.5767
305-92R	289	1	1	225.00	✓	52033	1.7531	390-50128	290	1	12	14.47	✓	50467	0.5592
305-93	289	1	20	253.50	✓	50093	2.5700	390-50130	284	1	25	44.21	✓	50468	1.1512
305-95	289	1	12	4.40	✓	50433	0.0813	390-50132	284	1	12	6.09	✓	50469	0.1932
305-99	290	1	10	85.00	✓	56645	0.0000	390-50133	284	1	12	8.28	✓	50470	0.4203
306-10	281	10	10	19.25	✓	50434	0.9720	390-50134	290	1	12	3.91	✓	50734	0.3890
306-12	281	1	5	22.82	✓	55624	0.0000	390-50138	292	1	12	6.26	✓	50473	0.0557
307-2	227	10	10	20.00		40020	0.3162	390-50139	292	1	12	1.86	✓	50474	0.0481
307-2P	227	10	10	25.50		40021	0.3905	390-50148	296	1	12	9.22		50477	1.6950
307-616	241	1	10	15.50	✓	40032	1.5926	390-50153	277	1	10	8.54	✓	50068	0.1733
307-625	241	1	6	7.10	✓	40013	0.9597	390-50154	277	1	10	7.07	✓	50069	0.0512
308-2	293	1	12	61.30	✓	55625	0.0000	390-50160	299	1	25	15.62	✓	50160	0.4343
308-5	293	1	5	46.52	✓	55626	0.0000	390-50163	277	1	10	22.62	✓	50065	0.2977
309-10	281	4	40	24.80	✓	50435	1.2310	390-50164	277	1	100	4.38	✓	50066	0.0327
309-12	281	1	5	27.50	✓	55627	0.0000	390-50175	300	1	20	2.04		50488	0.0782
310-05	294	1	12	17.37	✓	50436	0.1890	390-50176	300	50	50	0.89		50489	0.0567
310-08	293	1	24	5.50	✓	55628	0.0000	390-50177	298	50	250	0.46		50490	0.0537
310-09	293	1	12	6.60	✓	55629	0.0000	390-50178	298	10	100	0.40		50491	0.0260
310-10	293	1	24	3.00	✓	55632	0.1206	390-50179	298	100	500	0.28		50492	0.0234
311-10	283	1	10	32.96	✓	50438	2.1313	390-50180	300	2	20	1.15		50493	0.0390
312-2	296	18	18	8.95		50439	1.3220	390-50181	300	10	50	0.68		50494	0.0181
313-08	281	1	6	37.49	✓	56633	0.0000	390-50185	284	1	10	9.10	✓	50495	0.9229
313-10	281	1	6	56.65	✓	56634	0.0000	390-50191	281	1	10	15.76	✓	50497	0.5201
313-14	281	1	6	72.25	✓	56635	0.0000	390-50197	282	1	20	17.35	✓	50499	1.8151
313-18	281	1	6	102.45	✓	56636	0.0000	390-50198	283	1	20	5.64	✓	50500	0.5243
313-20	282	1	12	19.90	✓	56637	0.0000	390-50200	300	10	50	0.67		50502	0.1101
313-25	281	1	12	52.52	✓	56638	0.0000	390-50310	283	1	12	11.00	✓	50503	0.4683
313-26	281	1	10	85.40	✓	56639	0.0000	410	259	100	1000	0.78		50504	0.0470
314-1	291	10	100	3.60		50440	0.0455	410-PB	259	50	500	1.45		51900	0.0960
314-10	291	12	12	8.81		50441	0.3830	411	259	100	500	1.01		50506	0.0575
314-3	291	10	100	3.60		50442	0.0630	411-PB	259	50	250	2.01		51906	0.1179
315-1	278	10	100	1.60	✓	50443	0.0150	412-PB	259	50	250	1.80	✓	51901	0.0987
315-10	278	12	60	7.80		50444	0.4566	412-PBPK2	259	25	25	1.91	✓	30416	0.1022
316-1	282	1	6	23.50	✓	56640	0.0000	414-PB	259	50	250	2.59	✓	51902	0.1445
316-2	282	1	6	23.50	✓	56641	0.0000	415	259	100	500	1.00		50510	0.0694
318-20	291	1	5	55.00		56642	0.0000	415-PB	259	50	250	1.89		50511	0.1425
318-4	291	1	5	34.15	✓	56643	0.0000	416	259	100	500	1.12		50512	0.0604
318-9	293	1	10	14.25	✓	56644	0.0000	416-PB	259	50	250	2.34		51903	0.1245
319-09	299	50	50	1.82		50445	0.2400	416PK2	259	25	25	2.46		30406	0.1280
319-15	299	50	50	2.33		50446	0.3000	417	259	100	1000	0.13		50514	0.0095
319-20	299	50	50	2.50		50447	0.3400	418	259	100	1000	0.22		50515	0.0125
319-31	299	50	50	3.17		50448	0.4120	419	259	100	1000	0.12		50516	0.0061
330-260	295	24	24	7.85		50449	1.5500	420	258	100	100	0.50		50517	0.0297
332-260	295	24	24	18.20		50450	2.0563	420-PB	258	50	50	1.12		51012	0.0636
335-260	295	100	500	0.44		50451	0.0240	420-PBJ	258	1	1	61.00	✓	52037	3.1820
335-263	295	70	350	0.88		50452	0.0370	420-PBPK2	258	10	10	1.29	✓	30414	0.0771
335-520	295	100	500	0.54		50925	0.0280	421	258	100	100	0.50		50520	0.0272
335-523	295	70	350	0.99		50454	0.0300	421-PB	258	50	50	1.06		50521	0.0586
355-05PK2	231	1	10	8.80	✓	50455	0.5298	421-PBJ	258	1	1	56.65	✓	51895	2.9320
355-15PK1	231	1	10	17.10	✓	51801	0.6031	422	258	100	100	0.62		50522	0.0335
355-30PK1	231	1	10	17.10	✓	51803	0.6651	422-PB	258	50	50	1.36		51014	0.0709
355-60PK1	231	1	10	17.10	✓	51806	0.7051	422-PBJ	258	1	1	71.64	✓	52039	3.5449
356-100PK1	231	1	10	9.99	✓	51860	0.2851	422-PBPK2	258	10	10	1.47		30436	0.0841
356-160PK1	231	1	10	9.99	✓	51866	0.2791	425	258	100	100	0.46		30410	0.0200
356-30PK1	231	1	10	9.99	✓	50457	0.3051	425-PB	258	25	250	0.98		50526	0.0430
356-60PK1	231	1	10	9.99	✓	50458	0.2851	425-PBJ	258	1	1	50.50	✓	52036	2.1885
360-15PK1	231	1	10	7.25	✓	51851	0.2681	425-PBPK2	258	10	10	1.22	✓	30412	0.0577
360-300PK1	231	1	10	17.99		52030	0.0651	426	258	100	100	0.36		50528	0.0175

A 10% surcharge will be applied to any item NOT purchased in multiples of the stated Minimum Quantity, except on drop ship orders. Items that are bold in the Min Qty column may NEVER be broken.

Numerical Index

CATALOG 2007

NUMERICAL INDEX

NUMERICAL INDEX

NUMERICAL INDEX

NUMERICAL INDEX

NUMERICAL INDEX

Item No.	Page No.	Min Qty	Case Qty	List Price	UPC Bar-Coded	UPC 5-Digit 739236	Weight (lbs)
426-PB	258	50	50	0.91		50529	0.0386
426-PBJ	258	1	1	51.10	✓	50530	1.9711
427	258	100	100	0.54		50531	0.0238
427-PB	258	50	50	1.19		51013	0.0505
427-PBJ	258	1	1	65.14	✓	52038	2.5640
427-PBPK2	258	10	10	1.38		30434	0.0647
440-2W	260	1	25	2.60		55660	0.0000
440-2WPK	260	10	10	2.75		56656	0.0000
442-2W	260	1	25	1.65		56658	0.0000
442-2WPK	260	1	1	2.00		56657	0.0000
452-PB	260	50	50	3.60		30424	0.2289
460-10	270	100	1000	0.25		50535	0.0118
460-10J	270	1	1	56.00	✓	51904	4.7098
460-10TP	270	1	10	11.65	✓	50537	0.5704
460-11300	270	1	10	3.00		31510	0.0127
460-11310	270	1	10	3.80		31512	0.0125
460-20	270	100	1000	0.34		50540	0.0118
460-20J	270	1	1	72.00	✓	51905	4.7350
460-20TP	270	1	10	13.62	✓	50542	0.5704
460-30TP	270	1	10	12.60	✓	50543	0.5819
490-10105	265	1	25	2.82	✓	50546	0.1098
490-10106	265	25	25	2.52		50547	0.0972
490-10108	265	1	25	3.62	✓	50548	0.1094
490-10109	265	50	50	3.20		50549	0.1058
490-10110	265	1	25	3.82	✓	50550	0.1224
490-10111	265	50	50	3.34		50551	0.1189
490-10112	265	1	25	6.28	✓	50552	0.6274
490-10115	265	1	25	5.04	✓	50553	0.1468
490-10116	265	25	25	4.53		50554	0.1342
490-10120	265	1	25	5.98	✓	50555	0.1416
490-10121	265	1	25	6.94	✓	50556	0.1264
490-10122	265	1	50	1.58	✓	50557	0.0205
490-10125	265	1	20	4.23	✓	50558	0.1015
490-10126	265	25	25	3.44		50559	0.0899
490-10200	266	1	25	3.14	✓	50560	0.1224
490-10201	266	50	50	2.72		50561	0.1188
490-10205	266	1	20	4.59	✓	50562	0.1565
490-10206	266	25	25	4.18		50563	0.1512
490-10210	266	1	25	3.27	✓	50564	0.1334
490-10211	266	50	50	3.04		50565	0.1298
490-10302	264	1	25	2.97	✓	50566	0.0904
490-10303	264	50	50	2.70		50567	0.0811
490-10305	264	1	25	1.96	✓	50568	0.1184
490-10306	264	25	25	1.69		50569	0.1172
490-10312	264	1	25	3.11	✓	50570	0.0904
490-10313	264	50	50	2.72		50571	0.0811
490-10315	264	1	25	2.66	✓	50572	0.1234
490-10316	264	25	25	2.15		50573	0.1222
490-10320	264	1	25	2.79	✓	50574	0.0382
490-10325	266	1	12	9.36	✓	50575	0.3030
490-10340	264	1	25	3.49	✓	50578	0.0951
490-10341	264	1	25	1.81	✓	50579	0.0238
490-10360	269	1	25	2.95	✓	50580	0.0775
490-10375	269	1	25	4.86	✓	50586	0.0455
490-10383	269	10	1000	0.86		50589	0.0046
490-10411	268	25	100	0.93		50591	0.0359
490-10413	268	25	1000	0.42		50592	0.0173
490-10415	268	25	200	0.65		50593	0.0201
490-10423	268	25	100	1.60		50595	0.1169
490-10451	268	24	24	1.20		50596	0.2623
490-10465	268	1	1	12.63	✓	50598	1.2447
490-10466	268	1	25	3.20	✓	50599	0.0925
490-10467	268	1	1	4.73	✓	50600	0.1214
490-10500	260	1	50	4.86	✓	50601	0.2806
490-10502	260	25	250	0.32		50602	0.0069
490-10505	260	25	200	0.18		50658	0.0106

Item No.	Page No.	Min Qty	Case Qty	List Price	UPC Bar-Coded	UPC 5-Digit 739236	Weight (lbs)
490-10540	263	10	10	3.77		50604	0.3037
490-10541	263	10	10	3.37		50605	0.1857
490-10542	263	10	10	3.47		50606	0.2347
490-10543	263	10	10	4.10		50607	0.3396
490-10545	263	10	10	3.63		50609	0.3603
490-10546	263	10	10	4.30		30446	0.5003
490-10547	263	10	10	4.95		50611	0.4033
490-10548	263	10	10	6.30		50612	0.7435
490-10555	261	1	25	6.48	✓	50613	0.3507
490-10560	261	1	25	6.39	✓	50614	0.4181
490-10565	261	1	25	7.36	✓	50615	0.4241
490-10570	261	1	25	10.03	✓	50616	0.5304
490-10572	261	1	25	9.29	✓	50617	0.5624
490-10575	261	1	25	6.76	✓	50618	0.3517
490-10585	261	1	25	8.53	✓	50619	0.5460
490-10655	262	1	20	1.88	✓	50620	0.0755
490-10656	262	25	25	1.51		50621	0.0719
490-10660	262	1	20	1.89	✓	50622	0.1395
490-10661	262	25	25	1.37		50623	0.1342
490-10665	262	1	20	2.76	✓	50624	0.1455
490-10666	262	25	25	2.30		50625	0.1402
490-10670	262	1	20	3.35	✓	50626	0.1275
490-10671	262	25	25	2.98		50627	0.1222
490-10672	262	1	20	2.70	✓	50628	0.1595
490-10673	262	25	25	1.93		50629	0.1479
490-10675	262	1	20	2.62	✓	50630	0.0750
490-10676	262	25	25	1.98		50631	0.0729
490-10700	266	1	12	3.06	✓	50632	0.1049
490-11100	267	1	25	3.49	✓	50633	0.2702
490-11101	267	50	50	3.22		50634	0.2584
490-11120	267	1	15	6.30	✓	50635	0.3579
490-11130	267	1	12	4.38	✓	50636	0.1018
490-11140	267	1	12	4.95	✓	50637	0.1681
490-11150	263	1	12	7.06	✓	50640	0.6612
490-11151	263	1	12	7.76	✓	50641	0.7474
490-11152	263	5	25	1.88		50642	0.0889
490-11155	267	1	12	14.16	✓	50643	0.2931
490-11157	267	1	12	6.86	✓	50645	0.1481
490-11159	267	1	12	11.98	✓	50647	0.3451
490-11164	263	1	6	8.93	✓	50648	0.4097
490-11166	263	1	6	10.47	✓	50649	0.4267
490-11168	263	1	6	8.74	✓	50650	0.4327
490-11170	263	1	6	13.05	✓	50651	0.3667
490-11172	263	1	6	22.60	✓	50652	0.8087
490-11221	259	25	2500	0.34		50653	0.0083
490-11223	259	25	250	0.48		50654	0.0153
490-11227	259	25	250	0.50		50655	0.0133
490-11240	259	1	50	1.33	✓	50656	0.0848
490-11242	259	1	50	1.33	✓	50657	0.0848
490-11320	269	1	10	6.60	✓	30346	0.1878
490-11321	269	50	50	5.53		30349	0.1861
490-11322	270	1	10	19.50	✓	30348	0.8169
490-11520	263	5	25	1.54		50661	0.0779
490-11522	263	5	25	1.28		50662	0.0609
490-11530	263	5	25	1.10		50663	0.0589
500-2	199	100	500	0.30		20001	0.0220
500-3	199	100	500	0.35		20002	0.0240
501-0	199	100	500	0.10		26596	0.0180
501-OPK	199	100	100	0.21	✓	20440	0.0138
501-OPK3		10	10	11.50		20438	1.2708
501-1	199	100	500	0.11		26592	0.0190
501-1PK	199	100	100	0.23	✓	20441	0.0148
501-1PK3		10	10	12.50		20421	0.8200
501-2	199	100	500	0.105		26593	0.0210
501-2PK	199	100	100	0.24	✓	20423	0.0088
501-2PK2	199	10	10	2.17	✓	20422	0.1500

A 10% surcharge will be applied to any item NOT purchased in multiples of the stated Minimum Quantity, except on drop ship orders. Items that are bold in the Min Qty column may NEVER be broken.

Item No.	Page No.	Min Qty	Case Qty	List Price	UPC Bar-Coded	UPC 5-Digit 739236	Weight (lbs)	Item No.	Page No.	Min Qty	Case Qty	List Price	UPC Bar-Coded	UPC 5-Digit 739236	Weight (lbs)
501-2PK3		10	10	14.00		20424	0.6750	506-26PPK2	201	5	5	2.44	✓	20536	0.3270
501-3	199	100	500	0.13		26594	0.0152	506-32C	200	100	2000	0.12		20042	0.0180
501-3PK	199	100	100	0.27	✓	20427	0.0108	506-34	200	50	500	0.23		26570	0.0440
501-3PK2	199	10	10	2.49	✓	20426	0.1600	506-34C	200	50	500	0.26		20043	0.0440
501-3PK3		10	10	14.50		20428	0.9950	506-34CP	201	50	1000	0.39		20045	0.0440
501-4	199	100	100	0.20		26595	0.0362	506-34P	201	50	500	0.38		26575	0.0460
501-4PK	199	100	100	0.34	✓	20430	0.0260	506-34PK2		5	5	1.39		20510	0.2556
501-5	199	100	100	0.30		20008	0.0599	506-36	200	50	500	0.23		26571	0.0608
501-5PK	199	100	100	0.44	✓	20431	0.0340	506-36C	200	50	500	0.28		26579	0.0640
501-6	199	100	100	0.32		20009	0.0729	506-36CP	201	50	1000	0.42		20049	0.0616
501-6PK	199	100	100	0.46	✓	20432	0.0410	506-36CPK2	200	5	5	1.74	✓	20574	0.2800
501-7	199	100	100	0.35		20010	0.0929	506-36CPK3		1	1	14.04		20576	3.2000
501-7PK	199	100	100	0.49	✓	20433	0.0420	506-36P	201	50	500	0.40		26576	0.0650
502-0	199	100	100	0.13		20396	0.0140	506-36PK2	200	5	5	1.49	✓	20514	0.3130
502-0PK	199	100	100	0.24	✓	20395	0.0180	506-36PPK2	201	5	5	2.34	✓	20544	0.3330
502-1	199	100	100	0.14		20400	0.0180	506-36PPK3		1	1	20.04		20546	3.3630
502-1PK	199	100	100	0.25	✓	20399	0.0160	506-38	200	50	500	0.29		26572	0.0724
502-2	199	100	100	0.15		26552	0.0170	506-38C	200	50	500	0.33		26580	0.0760
502-2PK	199	100	100	0.26	✓	20403	0.0240	506-38CP	201	50	1000	0.50		20053	0.0760
502-2PK2	199	10	10	1.82	✓	20402	0.2300	506-38P	201	50	500	0.46		26577	0.0810
502-3	199	100	100	0.18		26554	0.0235	506-46	200	50	500	0.23		20524	0.0661
502-3PK	199	100	100	0.29	✓	20407	0.0270	506-46C	200	50	500	0.30		26581	0.0662
502-3PK2	199	10	10	2.12	✓	20406	0.2570	506-46CP	201	50	1000	0.52		20057	0.0662
502-4	199	100	100	0.28		26555	0.0830	506-46CPK2	200	5	5	1.84	✓	20582	0.3360
502-4PK	199	100	100	0.39	✓	20410	0.0440	506-46P	201	50	500	0.48		26578	0.0660
502-4PK2	199	10	10	1.31	✓	20392	0.1920	506-46PK2	200	5	5	1.49	✓	20522	0.3070
502-5	199	50	50	0.41		26556	0.1380	506-46PPK2	201	5	5	2.74	✓	20552	0.3270
502-5PK	199	50	50	0.52	✓	20412	0.0440	506-56	200	50	500	0.35		20059	0.0700
502-5PK2	199	10	10	1.83	✓	20393	0.2600	506-56P	201	50	500	0.54		20694	0.0617
502-6	199	50	50	0.45		26557	0.0800	506-66	200	50	500	0.39		20066	0.0700
502-6PK	199	50	50	0.56	✓	20414	0.0800	506-66P	201	50	500	0.56		20067	0.0636
502-7	199	50	50	0.59		26551	0.0960	506-710	200	50	50	0.48		20063	0.0950
502-75	199	25	25	1.21		20017	0.3000	506-78	200	50	50	0.46		20064	0.0820
502-75PK	199	20	20	1.32	✓	20417	0.1550	506-78P	201	50	50	0.66		20065	0.0809
502-7PK	199	50	50	0.70	✓	20416	0.0980	508-2PK	201	25	25	1.60	✓	20351	0.0791
502-8	199	25	25	1.45		26553	0.3600	508-3PK	201	25	25	1.65	✓	20355	0.0671
502-8PK	199	15	15	1.56	✓	20418	0.2000	508-4PK	201	25	25	1.70	✓	20358	0.0821
502-9	199	25	25	1.73		20019	0.5000	509	202	1	10	16.11		20069	2.1856
502-9PK	199	10	10	1.84	✓	20419	0.2400	509-PK2	202	20	20	1.85		20445	0.1142
503-2	200	100	1000	0.13		26563	0.0207	510-6PK	209	20	20	1.77	✓	26066	0.2823
503-2P	200	100	1000	0.25		26564	0.0205	510-6VPK	209	10	10	3.60	✓	26086	0.3044
503-3	200	100	1000	0.15		26565	0.0247	510-7PK	209	20	20	1.90	✓	26067	0.2933
503-3P	200	100	1000	0.28		26566	0.0247	510-7VPK	209	10	10	3.82	✓	26087	0.3165
503-3PK2	200	10	10	1.85	✓	20450	0.2691	510-8PK	209	20	20	2.38	✓	26069	0.3982
504-3	200	100	1000	0.15		20025	0.0225	510-8VPK	209	10	10	4.50	✓	26089	0.4161
504-3P	200	100	1000	0.30		26567	0.0227	510-9PK	209	20	20	2.66	✓	26070	0.4362
504-3PK2	200	10	10	1.82	✓	20462	0.2323	510-9VPK	209	10	10	5.35	✓	26090	0.4838
504-3PK3	200	1	10	15.08	✓	20464	2.1915	512-212PK	205	50	50	1.63	✓	21567	0.1285
504-3PPK2	200	10	10	3.32	✓	20466	0.2493	512-26PK	205	50	50	1.10	✓	21566	0.0810
505-24	220	100	100	0.49		20027	0.0497	512-312PK	205	50	50	1.63	✓	21575	0.1445
505-29	220	100	500	0.45		26549	0.0245	512-36PK	205	50	50	1.15	✓	21574	0.0900
505-34	220	100	100	0.52		20034	0.0491	512-412PK	205	50	50	2.03	✓	21583	0.0000
505-39	220	100	500	0.51		26550	0.0278	512-46PK	205	50	50	1.22	✓	21582	0.0890
505-49	220	50	50	0.72		20032	0.0339	513-26PK	205	25	25	1.60	✓	21509	0.0911
506-22C	200	100	2000	0.11		20033	0.0170	513-36PK	205	25	25	1.75	✓	21517	0.1021
506-24	200	50	500	0.20		26568	0.0420	515-10GPK2	203	10	10	4.54	✓	26110	1.3366
506-24C	200	50	500	0.23		20564	0.0420	515-2CPK2	203	10	10	1.78	✓	26122	0.1573
506-24CP	201	50	1000	0.38		20036	0.0622	515-2GPK2	203	10	10	1.63	✓	26102	0.1613
506-24P	201	50	500	0.40		26573	0.0415	515-3CPK2	203	10	10	1.81	✓	26123	0.1593
506-24PK3		1	1	17.66		20504	2.1000	515-3GPK2	203	10	10	1.69	✓	26103	0.1803
506-26	200	50	500	0.21		26569	0.0580	515-4CPK2	203	10	10	1.90	✓	26124	0.1413
506-26C	200	50	500	0.25		20568	0.0620	515-4GPK2	203	10	10	1.70	✓	26104	0.1983
506-26CP	201	50	1000	0.44		20040	0.0616	515-5CPK2	203	10	10	2.00	✓	26125	0.2341
506-26CPK2	200	5	5	1.59	✓	20566	0.2630	515-5GPK2	203	10	10	1.94	✓	26105	0.2891
506-26P	201	50	500	0.42		26574	0.0660	515-6CPK2	203	10	10	2.10	✓	26126	0.2924
506-26PK2	200	5	5	1.39	✓	20506	0.3070	515-6GPK2	203	10	10	2.23	✓	26106	0.2624

NUMERICAL INDEX

NUMERICAL INDEX

NUMERICAL INDEX

NUMERICAL INDEX

NUMERICAL INDEX

Numerical Index

CATALOG 2007

NUMERICAL INDEX

NUMERICAL INDEX

NUMERICAL INDEX

NUMERICAL INDEX

NUMERICAL INDEX

Item No.	Page No.	Min Qty	Case Qty	List Price	UPC Bar-Coded	UPC 5-Digit 739236	Weight (lbs)
515-7CPK2	203	10	10	2.38	✓	26127	0.4064
515-7GPK2	203	10	10	2.34	✓	26107	0.3288
515-8GPK2	203	10	10	3.75	✓	26108	0.8826
515-9GPK2	203	10	10	4.23	✓	26109	0.9526
516-2CPK2	203	20	20	1.40	✓	26342	0.1104
516-2GPK2	203	20	20	1.25	✓	26322	0.1274
516-3CPK2	203	20	20	1.50	✓	26343	0.1244
516-3GPK2	203	20	20	1.44	✓	26323	0.1694
516-4CPK2	203	10	10	1.75	✓	26344	0.1703
516-4GPK2	203	10	10	1.50	✓	26324	0.1923
516-5CPK2	203	10	10	1.90	✓	26345	0.1423
516-5GPK2	203	10	10	1.88	✓	26325	0.2203
516-6CPK2	203	10	10	2.23	✓	26346	0.2323
516-6GPK2	203	10	10	2.10	✓	26326	0.3026
516-7CPK2	203	10	10	2.35		26347	0.2793
516-7GPK2	203	10	10	2.10	✓	26327	0.2638
520-16	214	100	100	1.00		20660	0.1580
520-1624	214	100	100	3.65		20661	0.3262
520-165020Q	214	100	100	4.00		20662	0.3999
520-16C	214	100	100	1.31		20663	0.1570
520-16CPK	214	100	100	1.65	✓	20802	0.1616
520-19	214	50	50	1.24		20664	0.2160
520-19C	214	50	50	2.30		20665	0.2160
520-19CPK	214	50	50	2.88	✓	20906	0.2285
520-19PK	214	50	50	1.55	✓	20902	0.2285
520-19T	214	50	50	1.41		20666	0.2040
520-19TC	214	50	50	2.36		20667	0.1920
520-24	214	25	25	1.68		20668	0.2920
520-24C	214	25	25	2.80		20669	0.3840
520-419	214	50	50	2.47		20670	0.1920
520-419C	214	50	50	3.40		20671	0.2060
520-419T	214	50	50	2.47		20672	0.2080
520-419TC	214	50	50	3.41		20673	0.1800
521-110	217	25	25	6.15		20120	0.7125
521-118	215	50	50	2.94		20674	0.3540
521-118R	215	25	25	3.25		20675	0.4160
521-126	215	50	50	4.89		20676	0.6584
521-210	206	25	100	0.98		20677	0.0697
521-318	215	50	50	2.73		20678	0.6000
521-360	215	50	50	3.30		20679	0.7640
521-557	216	25	25	0.80		26598	0.0075
521-558	216	25	25	0.90		20680	0.1640
521-559	216	25	25	1.25		26616	0.1867
521-6415	216	25	25	2.71		20681	0.3050
521-6416	216	25	25	2.71		26585	0.3532
521-723	217	25	25	6.75		26615	0.0000
521-723B	217	25	25	6.00		26632	0.0000
521-726	217	5	5	9.27		20682	0.9320
521-810	215	50	50	3.85		20683	0.3880
521-810PK	215	50	50	4.20	✓	22020	0.3880
521-820	215	50	50	3.65		20684	0.2560
521-851	215	50	50	2.50		20685	0.3400
521-851PK	215	50	50	2.80	✓	20702	0.3541
521-852	215	50	50	4.25		20686	0.5800
522-100B	195	1	100	31.00		20133	0.0024
522-100BPK2	195	1	10	3.75	✓	26618	0.0243
522-101	211	100	100	0.17		20135	0.0089
522-16	211	50	50	2.46		20131	0.1922
522-1604	211	50	50	2.81		20129	0.2246
522-1610	211	50	50	3.21		20128	0.2291
522-1614	211	50	50	3.36		20139	0.2451
522-161463	211	50	50	3.48		20803	0.2397
522-1620	211	50	50	3.66		20140	0.2606
522-162001	211	1	1	178.00		20141	12.8514
522-1620PK1	211	10	10	5.10	✓	20922	0.2917
522-1624	211	50	50	3.81		20142	0.2726

A 10% surcharge will be applied to any item NOT purchased in multiples of the stated Minimum Quantity, except on drop ship orders. Items that are bold in the Min Qty column may NEVER be broken.

Item No.	Page No.	Min Qty	Case Qty	List Price	UPC Bar-Coded	UPC 5-Digit 739236	Weight (lbs)
522-162401	211	1	1	185.50		20143	13.4576
522-16245	211	50	50	3.81		20144	0.2686
522-162463	211	50	50	3.93		20145	0.2673
522-1630	211	50	50	4.41		20146	0.2881
522-1634	211	50	50	4.56		20147	0.3001
522-24	211	50	50	3.18		20149	0.2700
522-2404	211	50	50	3.53		20150	0.2946
522-2414	211	50	50	4.08		20151	0.3151
522-241463	211	50	50	4.20		20804	0.3097
522-2420	211	50	50	4.38		20153	0.3306
522-242001	211	1	1	214.00		20127	16.3514
522-2424	211	50	50	4.53		20126	0.3426
522-242401	211	1	1	221.50		20155	16.9576
522-24245	211	50	50	4.53		20125	0.3386
522-242463	211	50	50	4.65		20157	0.3373
522-2434	211	50	50	5.28		20124	0.3701
522-5500	211	100	100	0.43		20159	0.0317
522-5501	211	100	100	0.61		20692	0.0374
523-01	213	10	50	1.92		20161	0.0937
523-1	216	50	50	1.14		20123	0.0601
523-16	213	50	50	3.00		26646	0.0000
523-1604	213	50	50	3.35		26644	0.0000
523-1610	213	50	50	3.75		26647	0.0000
523-1614	213	50	50	3.90		26636	0.0000
523-1620	213	50	50	4.20		26635	0.0000
523-162001	213	1	1	205.00		26637	0.0000
523-1620N	213	50	50	4.20		26634	0.0000
523-1624	213	50	50	4.35		26638	0.0000
523-162401	213	1	1	212.50		26639	0.0000
523-1630	213	50	50	4.95		26643	0.0000
523-1634	213	50	50	5.10		26640	0.0000
523-16N	213	50	50	3.00		26645	0.0000
523-1B	216	5	50	2.96		20163	0.1637
523-1K52000	213	10	10	5.46		20164	0.5004
523-24	213	50	50	3.90		20166	0.4963
523-2404	213	50	50	4.25		20167	0.5465
523-2414	213	50	50	4.80		20168	0.5634
523-2420	213	50	50	5.10		20169	0.5697
523-242001	213	1	1	250.00		20122	28.3089
523-2420N	213	50	50	5.10		26642	0.0000
523-2424	213	50	50	5.25		20171	0.5909
523-242401	213	1	1	257.50		20121	29.3733
523-2424PK2	213	12	12	19.00	✓	26613	2.3580
523-2434	213	50	50	6.00		20173	0.6184
523-24N	213	50	50	3.90		26641	0.0000
523-31	198	100	100	0.57		20174	0.0283
523-32	198	100	100	0.57		20175	0.0403
523-33	198	50	50	0.79		20176	0.0478
523-34	198	50	50	0.98		20177	0.0618
523F2424	213	50	50	7.25		20807	0.6259
523F5500	211	100	100	1.85		26599	0.0490
524-10	209	50	50	1.40		20178	0.6000
524-100	209	5	5	14.90		20179	5.5880
524-10B	209	25	25	1.45		20180	0.6440
524-10C	209	50	50	3.77		20181	0.6650
524-10CPK2	209	10	10	3.98	✓	20316	0.4650
524-10PK	209	50	50	1.66		20303	0.5800
524-10PK2	209	10	10	1.56	✓	20302	0.6270
524-50	209	10	10	7.76		20182	3.2400
524-50PK3	209	1	1	8.00	✓	20306	2.1300
525-18	214	100	100	1.00		26600	0.1980
525-20	214	100	100	1.10		26601	0.2300
525-26	214	100	100	1.25		26602	0.3079
528-10	209	50	50	1.37		20183	0.4740
528-100	209	5	5	12.42		20184	3.3260
528-10B	209	25	25	1.47		20185	0.4580

Item No.	Page No.	Min Qty	Case Qty	List Price	UPC Bar-Coded	UPC 5-Digit 739236	Weight (lbs)	Item No.	Page No.	Min Qty	Case Qty	List Price	UPC Bar-Coded	UPC 5-Digit 739236	Weight (lbs)
528-10PK		50	50	1.69		20309	0.3040	550-20QPK2	196	1	10	9.80	✓	26617	1.1638
528-10PK2		10	10	1.78		20308	0.3400	550-22	196	1	1	54.00		20230	4.8500
528-50	209	10	10	6.21		20186	2.5000	550-22T	197	1	1	87.00		26631	4.6750
530-163	222	100	100	0.191		26582	0.0740	550-2T	197	25	25	1.85		20232	0.1134
530-1635	222	100	100	0.48		20188	0.2190	550-2T1	197	25	25	2.20		26624	0.1384
530-165	222	100	100	0.30		20607	0.1300	550F11	195	25	25	3.00		20041	0.0440
530-166	222	100	100	0.28		20190	0.1520	550F20	196	25	25	7.95		20046	0.1425
530-3	222	100	100	0.15		20191	0.0710	550F2T	197	5	5	8.45		20048	0.1754
530-3PK	222	100	100	0.25	✓	20602	0.0580	550-M1	220	50	50	0.83		20234	0.0480
530-5	222	100	100	0.22		26583	0.1000	550-M2	220	50	50	0.93		20235	0.1013
530-5PK	222	100	100	0.29	✓	20604	0.0938	550-M3	220	25	25	1.55		20236	0.2300
530-6	222	100	100	0.233		20193	0.1260	550-MP2	220	25	25	2.80		20238	0.2048
530-6M	222	100	100	0.233		26614	0.1490	550-MP2PK	220	10	10	3.20	✓	20854	0.2299
533-1	221	25	25	2.30		20194	0.5780	551-2	194	100	1000	0.13		20239	0.0131
533-1H	221	12	12	14.75		26603	1.1467	551-2BK	194	1	1	130.06		20240	13.9370
533-1PK	221	25	25	2.41	✓	20751	0.4490	551-2C	194	100	1000	0.13		20241	0.0132
533-2	221	25	25	2.60		20195	0.6780	551-2CBK	194	1	1	130.06		20242	13.9870
533-2H	221	12	12	15.75		26604	1.5250	551-2CPK2	194	10	10	1.69	✓	20024	0.1633
533-2PK	221	25	25	2.71	✓	20752	0.6176	551-3	194	50	500	0.17		26528	0.0206
533-3	221	10	10	3.10		20196	0.6600	551-3BK	194	1	1	102.04		20244	12.9670
533-3H	221	12	12	17.50		26605	1.7133	551-3C	194	50	500	0.17		20031	0.0218
535-14	208	25	25	2.35		20197	0.7600	551-3CBK	194	1	1	102.04		20246	13.7110
535-26	208	25	25	3.43		20198	1.1040	551-3CPK2	194	10	10	2.09	✓	20028	0.2886
535-914	208	25	25	2.31		20199	0.6144	551-4	194	25	250	0.48		20247	0.0324
535-926	208	25	25	3.26		20200	0.9659	551-4BK	194	1	1	168.00		20248	12.0155
535-9P	208	50	50	0.63		20201	0.0998	551-4C	194	25	250	0.48		20249	0.0333
536-09	222	50	50	0.57		20202	0.2200	551-4CBK	194	1	1	168.00		20250	12.0155
536-12	222	50	50	0.72		20203	0.3500	551-P2	194	100	1000	0.16		26529	0.0172
536-18	222	50	50	1.08		20204	0.4280	551-P2PK2	194	10	10	2.00	✓	20054	0.1935
536-35	222	100	100	0.50		20205	0.2600	551-P2PK3		10	10	15.98		20056	1.7452
536-36	222	50	50	0.75		26606	0.3520	551-P2S	194	100	1000	0.24		26544	0.0323
536-58	222	50	50	1.60		20206	0.7152	551-P3	194	50	500	0.27		26530	0.0228
536-612	222	25	25	2.15		26607	1.0523	551-P3PK2	194	10	10	3.00	✓	20058	0.2808
536-85	222	50	50	1.55		20207	0.5960	551-P3PK3		10	10	13.47		20060	1.1886
536-85PK	222	50	50	1.60	✓	20627	0.6720	551-P3S	194	50	500	0.35		20062	0.0389
538-09	222	50	50	0.49		20208	0.1940	553-010B	207	25	100	2.21		25300	0.1710
538-09PK	222	50	50	0.54	✓	20622	0.1640	553-010W	207	25	100	2.21		25301	0.1720
538-12	222	50	50	0.60		20209	0.2520	553-014B	207	25	100	2.68		25302	0.2070
538-18	222	50	50	0.93		20210	0.4000	553-014BPK	207	25	25	2.73	✓	20284	0.2426
539-18	222	50	50	2.19		20211	0.9970	553-014W	207	25	100	2.68		25303	0.2080
539-518	222	25	25	3.42		20808	1.4320	553-014WPK	207	25	25	2.73	✓	25284	0.2426
539-6	222	50	50	0.75		20212	0.3920	553-026B	207	25	50	4.17		25304	0.3221
540	204	20	20	0.91		20213	0.1300	553-026W	207	25	50	4.17		25305	0.3231
541-CPK2	204	20	20	1.53	✓	26363	0.2014	553-0LB	207	1	100	1.29		25306	0.0659
541-GPK2	204	20	20	1.20	✓	26362	0.2114	553-0LW	207	1	100	1.29		25307	0.0659
542-PK2	204	10	10	1.66	✓	26401	0.3973	553-22W	205	50	150	1.00	✓	25200	0.0575
543	204	10	10	1.70		20217	0.4510	553-23W	205	50	150	1.12	✓	25201	0.0645
544	204	20	20	4.08	✓	26451	1.7400	553-2W	205	50	50	0.67	✓	25204	0.0341
549-712	208	50	100	2.05		20218	0.1293	553-33W	205	50	150	1.12	✓	25203	0.0655
549-734	208	25	100	2.10		20219	0.1465	553-3W	205	50	50	0.75	✓	25208	0.0354
550	221	50	50	0.60		20220	0.0538	553-4W	205	50	50	0.82	✓	25212	0.0390
550-11	195	100	100	0.53		20221	0.0308	553-5W	205	50	50	0.93	✓	25244	0.0461
550-11E	197	100	100	1.98		26621	0.0650	553-6	206	50	50	0.90	✓	25207	0.0724
550-11PK2	195	10	10	3.30	✓	20044	0.1354	553-6W	206	50	50	0.82	✓	25216	0.0789
550-11PK4	195	1	1	30.00	✓	20470	1.6903	553-7	206	50	50	0.96	✓	25287	0.0952
550-11Q	195	100	100	1.16		20223	0.0352	553-7W	206	50	50	0.87	✓	25220	0.0985
550-11QPK2	195	1	10	11.75	✓	26619	0.3521	553-8	206	50	50	1.07	✓	25209	0.1205
550-12	195	1	1	36.00		20224	2.4972	553-830W	206	50	50	1.10	✓	25285	0.1267
550-20	196	50	50	1.28		20047	0.1001	553-8W	206	50	50	0.98	✓	25224	0.1279
550-200B	196	1	10	26.00		20228	0.0093	553-9	206	25	25	1.16	✓	25211	0.1510
550-200BPK2	196	1	10	5.50	✓	26628	0.0934	553-9W	206	25	25	1.10	✓	25228	0.1536
550-201		25	25	0.35		26623	0.0250	554-08	202	100	2500	0.071		20280	0.0033
550-20E	197	25	25	2.80		26622	0.1649	554-100	209	1	20	9.90		20328	1.5000
550-20PK2	196	10	10	1.81	✓	20047	0.1114	554-10PK2	209	10	10	1.73	✓	20322	0.2114
550-20PK4	196	1	1	31.99	✓	26609	1.7196	554-14	202	100	1000	0.14		26545	0.0056
550-20Q	196	50	50	1.58		20229	0.1164	554-21	202	50	500	0.47		20283	0.0286

A 10% surcharge will be applied to any item NOT purchased in multiples of the stated Minimum Quantity, except on drop ship orders. Items that are bold in the Min Qty column may NEVER be broken.

Numerical Index

CATALOG 2007

NUMERICAL INDEX

NUMERICAL INDEX

NUMERICAL INDEX

NUMERICAL INDEX

NUMERICAL INDEX

Item No.	Page No.	Min Qty	Case Qty	List Price	UPC Bar-Coded	UPC 5-Digit 739236	Weight (lbs)
554-25	209	1	20	2.98		20324	0.4400
554-36	202	50	250	0.64		20285	0.0444
554-608	202	100	500	0.18		20286	0.0048
554-614	202	100	1000	0.28		20287	0.0076
555-1	192	100	1000	0.13		26531	0.0071
555-2	192	100	1000	0.075		26532	0.0097
555-23	192	100	1000	0.125		26535	0.0155
555-23BK	192	1	1	106.25		20292	14.0970
555-23PK2	192	10	10	1.60	✓	20092	0.1774
555-23S	192	100	1000	0.28		26633	0.0359
555-2BK	192	1	1	135.00		20293	17.7862
555-3	192	100	1000	0.113		26533	0.0148
555-3BK	192	1	1	113.00		20295	15.5870
555-4	192	50	500	0.32		26534	0.0236
555-45	192	25	100	0.48		20297	0.0311
555-45BK	192	1	1	168.00		20810	10.9515
555-45S	192	25	100	0.64		20298	0.0297
555-4BK	192	1	1	160.00		20299	12.5870
555-623	192	100	1000	0.17		20300	0.0135
556-1	193	100	1000	0.13		20301	0.0076
556-1BK	193	1	1	299.00		20811	26.5739
556-1C	193	100	1000	0.13		20700	0.0075
556-2	193	100	1000	0.075		20699	0.0094
556-2BK	193	1	1	120.00		20304	15.4470
556-2C	193	100	1000	0.075		20305	0.0093
556-2CBK	193	1	1	120.00		20291	15.2998
556-2CPK4	193	1	1	27.50	✓	26612	2.1674
556-2PK2	193	10	10	1.14	✓	20074	0.1101
556-2PK3	193	10	10	7.60	✓	20076	0.9433
556-2PK4	193	1	1	27.50	✓	20471	2.1674
556-2S	193	100	1000	0.24		20307	0.0104
556-3	193	100	1000	0.113		20698	0.0150
556-3BK	193	1	1	90.40		20701	12.7270
556-3C	193	100	1000	0.113		20310	0.0150
556-3CBK	193	1	1	90.40		20311	12.7270
556-3CPK4	193	1	1	27.50	✓	56613	2.5174
556-3PK2	193	10	10	1.55	✓	20078	0.1713
556-3PK3	193	10	10	11.40	✓	20080	1.5199
556-3PK4	193	1	1	27.50	✓	20472	2.5174
556-3S	193	100	1000	0.27		20312	0.0155
556-4	193	50	500	0.32		20695	0.0267
556-4BK	193	1	1	128.00		20314	11.6426
556-4C	193	50	500	0.32		20315	0.0265
556-4CBK	193	1	1	128.00		20696	11.5670
556-4PK3	193	10	10	16.05	✓	20082	1.3831
557-2	197	100	1000	0.22		20689	0.0089
557-2PK2	197	10	10	1.50	✓	20170	0.0714
557-3	197	100	1000	0.23		20319	0.0115
557-3PK2	197	10	10	1.58	✓	20172	0.0814
557-4	197	50	500	0.52		20321	0.0156
557-5	197	25	250	0.96		20697	0.0256
557-6	197	25	250	1.08		20323	0.0307
557-7	197	25	250	1.40		20290	0.0405
557F2	197	100	1000	1.25		20325	0.0163
557F3	197	100	1000	1.50		20326	0.0212
557F4	197	50	500	2.05		20327	0.0291
558-2	198	50	500	0.36		26541	0.0210
558-2PK2	198	10	10	1.92	✓	20152	0.1244
558-3	198	50	500	0.37		26542	0.0164
558-3PK2	198	10	10	1.97	✓	20156	0.1033
558-4	198	25	250	0.38		26543	0.0158
558-E1	191	50	500	0.35		20336	0.0208
558-E2	191	50	500	0.26		26538	0.0193
558-E2PK2	191	10	10	1.60	✓	20130	0.1176
558-E3	191	50	500	0.27		26539	0.0174
558-E3PK2	191	10	10	1.65	✓	20134	0.1083

A 10% surcharge will be applied to any item NOT purchased in multiples of the stated Minimum Quantity, except on drop ship orders. Items that are bold in the Min Qty column may NEVER be broken.

Item No.	Page No.	Min Qty	Case Qty	List Price	UPC Bar-Coded	UPC 5-Digit 739236	Weight (lbs)
558-E4	191	25	250	0.37		26540	0.0163
558-E4PK2	191	10	10	2.25	✓	20137	0.0983
558FM2	191	10	100	1.20		20346	0.0151
558FM3	191	10	100	1.30		20347	0.0173
558FM4	191	5	25	1.40		20348	0.0185
558-M2	191	100	1000	0.22		26597	0.0072
558-M2G	191	100	1000	0.22		26625	0.0083
558-M2R	191	100	1000	0.27		20341	0.0073
558-M3	191	100	1000	0.24		26611	0.0070
558-M3G	191	100	1000	0.24		26626	0.0124
558-M3R	191	100	1000	0.30		20343	0.0070
558-M4	191	25	250	0.28		20344	0.0062
558-M4G	191	25	250	0.28		26627	0.0783
558-M4R	191	25	250	0.33		20345	0.0063
559-2	198	100	1000	0.22		26536	0.0105
559-2PK2	198	10	10	1.28	✓	20110	0.0779
559-3	198	50	1000	0.23		20331	0.0136
559-3PK2	198	10	10	1.32	✓	20114	0.0914
559-4	198	50	500	0.52		26537	0.0191
559-5	198	25	250	0.68		20354	0.0322
559-6	198	25	250	1.07		20353	0.0370
559-7	198	25	250	1.18		20342	0.0484
559F2	198	100	1000	1.25		20357	0.0199
559F3	198	50	1000	1.50		20340	0.0253
559F4	198	50	500	2.05		20339	0.0364
570	218	24	24	3.40		20363	0.3040
570-10	218	24	24	6.45		20364	0.4460
570-20	218	24	24	7.80		20365	0.5460
570-22	218	24	24	8.63		20338	0.5420
570-24	218	24	24	9.26		20367	0.5660
570-53	218	50	50	0.96		20337	0.0351
571	219	24	24	3.00		20370	0.3258
571-10	219	24	24	3.90		20371	0.4083
571-145	219	24	24	6.85		20373	0.7078
571-20	219	24	24	5.70		20691	0.5083
571-22	219	24	24	6.40		20375	0.5043
572	218	24	24	5.09		26586	0.3491
572-20	218	24	24	10.18		20379	0.6133
572-22	218	24	24	11.13		20380	0.6093
572-24	218	24	24	11.40		20381	0.6333
572-53	218	50	50	1.11		20813	0.0421
572-58	218	50	50	1.43		20382	0.0710
574-104	216	50	50	2.73		50664	0.1299
574-72	216	50	50	1.77		50665	0.1081
574-75	218	50	50	2.41		50666	0.1041
590-08	202	1	10	8.00		20383	0.9325
590-10	202	1	10	7.69		50302	1.0693
591-08	202	1	10	4.00		20385	0.0055
591-081	202	1	10	4.80		26630	0.5313
591-10	202	1	10	4.30		20386	0.0071
591-63SSB	202	1	10	17.00		20814	0.1711
592-10	202	1	10	3.30		20387	0.0012
593-10	202	1	50	1.50		20388	0.0430
600-203	25	50	500	1.63		40011	0.0768
600-204CV	25	10	10	22.98	✓	44040	0.8182
600-204V	25	10	10	13.78	✓	40040	0.5299
600-206	25	25	250	2.74		40014	0.1533
600-206C	25	25	25	11.01		40015	0.3650
600-206CPK	25	10	10	11.36	✓	44056	0.3741
600-206PK	25	10	10	2.88	✓	40056	0.1678
600-212	25	50	50	4.92		40016	0.3081
600-212C	25	25	25	13.24		40017	0.5201
600-212CPK	25	10	10	13.38	✓	44062	0.5291
600-212N	26	25	25	10.16		40018	0.3387
600-212PK	25	10	10	5.06	✓	40062	0.3251
600-303	25	25	250	2.26		40019	0.1210

Item No.	Page No.	Min Qty	Case Qty	List Price	UPC Bar-Coded	UPC 5-Digit 739236	Weight (lbs)	Item No.	Page No.	Min Qty	Case Qty	List Price	UPC Bar-Coded	UPC 5-Digit 739236	Weight (lbs)
600-304CV	25	10	10	37.85		44042	1.5931	608-L248	15	50	50	3.50		40068	0.2426
600-304V	25	10	10	18.90	✓	40042	1.0238	608-L2488	19	25	25	18.45		40069	1.3304
600-306	25	50	50	3.98		40022	0.2431	608-L2488E	19	25	25	19.45		40070	1.4499
600-306C	25	25	25	20.63		40023	0.6575	608-L248PK	15	50	50	3.64	✓	45720	0.2525
600-306CPK	25	10	10	20.76	✓	44076	0.6665	608-L2508	19	25	25	19.19		40071	1.3770
600-306PK	25	10	10	4.12	✓	40076	0.2528	608-L2508E	19	25	25	20.19		40072	1.4965
600-312	25	50	50	7.36		40024	0.4799	608-L2508EX	19	25	25	23.48		40073	1.7785
600-312C	25	25	25	23.50		40025	0.8931	608-L2508EY	19	25	25	23.54		40074	1.8823
600-312CPK	25	10	10	23.64	✓	44082	0.9213	608-L2508X	19	25	25	22.48		40350	1.6590
600-312N	26	25	25	12.77		40026	0.5109	608-L2508Y	19	25	25	22.54		40075	1.4287
600-312PK	25	10	10	7.50	✓	40082	0.4951	608-L2612	15	50	50	5.81		40031	0.3975
600-40170	246	6	6	5.36	✓	44131	0.5771	608-L2812	15	50	50	6.35		40078	0.4415
600-40171	246	6	6	5.36	✓	44132	0.6100	608-L348	15	50	50	7.36		40079	0.4315
600-40172	246	6	6	5.57	✓	44133	0.5781	608-L3612	15	50	50	11.27		40080	0.6606
600-40173	246	6	6	6.38	✓	44134	0.6401	608-L3812	15	50	50	12.28		40081	0.7202
600-40174	246	6	6	6.88	✓	44135	0.6361	608-L4612	15	25	25	17.51		40029	0.9658
600-40175	246	6	6	8.53	✓	44136	0.6911	608-L4812	15	25	25	18.70		40083	1.0461
600-40176	246	6	6	8.66	✓	44137	0.7361	609-D288E	16	25	25	12.58		40084	0.5812
600-40181	246	6	6	8.83	✓	44162	1.1361	609-L2138	16	50	50	6.76		40085	0.4620
600-40182	246	6	6	10.28	✓	44163	1.1171	609-L246	16	50	50	3.17		40086	0.2069
600-40183	246	6	6	10.47	✓	44164	1.1461	609-L246E	16	25	25	4.17		40087	0.2985
600-40184	246	6	6	12.50	✓	44165	1.1861	609-L248	16	50	50	3.62		40088	0.2426
600-40185	246	6	6	14.65	✓	44166	1.3071	609-L248E	16	25	25	4.62		40089	0.3000
600-40186	246	6	6	15.67	✓	50681	1.4777	609-L2612	16	50	50	6.05		40090	0.3962
601-20CV	28	6	6	22.46	✓	40204	0.7380	609-L263A	19	50	50	3.18		40091	0.1932
601-20V	28	6	6	19.11	✓	40200	0.5251	609-L263X	19	50	50	6.65		40092	0.2638
601-21CV	28	6	6	19.83	✓	40234	0.2547	609-L263Y	19	50	50	5.47		40093	0.2449
601-21V	28	6	6	16.69	✓	40230	0.4997	609-L27	19	50	50	4.86		40094	0.2152
601-22	27	10	10	5.97	✓	40226	0.1109	609-L2812	16	50	50	6.63		40095	0.4409
601-22CVM	28	6	6	20.82	✓	40220	0.2599	609-L3248	16	50	50	4.16		40096	0.2607
601-22CVX	28	6	6	20.03	✓	40212	0.2599	609-L348	16	50	50	8.21		40097	0.4338
601-22VM	28	6	6	17.84	✓	40216	0.5210	609-L3612	16	50	50	11.80		40098	0.6606
601-22VX	28	6	6	16.51	✓	40208	0.5051	609-L3812	16	50	50	12.57		40099	0.7202
601-30CV	28	6	6	27.95	✓	40206	0.9583	609-L4612	16	25	25	18.00		40100	0.9658
601-30V	28	6	6	20.98	✓	40202	0.5609	609-L4812	16	25	25	19.28		40101	1.0461
601-31CV	28	6	6	26.63	✓	40236	0.3419	612-108	17	25	25	6.86		40102	0.4588
601-31V	28	6	6	18.28	✓	40232	0.5355	612-2	220	50	500	1.34		20389	0.0295
601-32	27	10	10	7.44	✓	40228	0.1467	612-2PK2	220	10	10	6.99	✓	46522	0.1700
601-32CVM	28	6	6	26.89	✓	40222	0.3471	612-3	220	25	250	1.40		46523	0.0371
601-32CVX	28	6	6	27.22	✓	40214	0.3471	612-3PK2	220	10	10	8.45	✓	26610	0.2077
601-32VM	28	6	6	19.37	✓	40218	0.5568	612-4	220	25	250	1.64		46542	0.0251
601-32VX	28	6	6	18.10	✓	40210	0.5409	612-557	17	25	25	7.17		40103	0.4011
602-L2015	26	100	100	0.76		40045	0.0345	612-57	17	25	25	4.73		46410	0.3168
602-L202	26	100	100	0.95		40046	0.0453	612-87	17	25	25	5.72		40104	0.3904
602-L2025	26	100	100	1.10		40047	0.0560	613-107	17	50	50	5.43		40106	0.3720
602-L203	26	100	100	1.25		40048	0.0668	613-137	17	50	50	6.30		40107	0.4388
602-L2035	26	100	100	1.51		40049	0.0776	613-139	17	50	50	6.85		40108	0.4833
602-L204	26	100	100	1.56		40050	0.0884	613-57	17	50	50	3.79		40109	0.2576
602-L2045	26	100	100	1.71		40051	0.0994	613-57E	17	25	25	4.79		40110	0.3168
602-L205	26	100	100	1.87		40052	0.1102	613-57M	14	50	50	6.37		40111	0.3238
602-L2055	26	100	100	2.01		40053	0.1210	613-57PK	17	20	20	3.94	✓	40105	0.2794
602-L206	26	100	100	2.14		40054	0.1318	613-57X	17	50	50	7.23		40112	0.3300
602-L2K	26	1	1	142.65		40055	8.7298	613-57Y	17	50	50	6.12		40113	0.3111
608-D288E	16	25	25	12.23		40028	0.5812	613-67	17	50	50	4.05		40114	0.2794
608-L2138	15	50	50	6.43		40057	0.4607	613-67M	17	50	50	6.58		40115	0.3496
608-L2187	15	50	50	7.68		40058	0.5506	613-67X	17	50	50	7.27		40116	0.3600
608-L2277	15	50	50	11.00		40059	0.7503	613-67Y	17	50	50	6.15		40117	0.3411
608-L2308	19	25	25	13.31		40060	0.8608	613-87	17	50	50	4.62		40118	0.3252
608-L2308E	19	25	25	14.31		40061	0.9161	613-87E	17	25	25	5.62		40119	0.4003
608-L2308EX	19	25	25	17.39		40030	1.0708	613-87M	17	50	50	7.09		40120	0.3896
608-L2308EY	19	25	25	16.87		40063	1.1937	613-87X	17	50	50	8.18		40121	0.3987
608-L2308X	19	25	25	16.39		40064	0.9314	613-87Y	17	50	50	7.13		40122	0.3869
608-L2308Y	19	25	25	15.87		40065	0.9125	613-887L	18	25	25	8.33		40353	0.5148
608-L2337	15	50	50	13.37		40066	0.9135	613-887R	18	25	25	8.33		40354	0.5148
608-L246	15	50	50	2.98		40067	0.2028	614-2	26	50	500	1.19		40152	0.0338
608-L246PK	15	50	50	3.12	✓	45710	0.2153	614-22C	27	25	250	3.75		40158	0.1328

A 10% surcharge will be applied to any item NOT purchased in multiples of the stated Minimum Quantity, except on drop ship orders. Items that are bold in the Min Qty column may NEVER be broken.

Numerical Index

CATALOG 2007

NUMERICAL INDEX

NUMERICAL INDEX

NUMERICAL INDEX

NUMERICAL INDEX

NUMERICAL INDEX

Item No.	Page No.	Min Qty	Case Qty	List Price	UPC Bar-Coded	UPC 5-Digit 739236	Weight (lbs)
614-3	26	50	500	1.73		40125	0.0395
614-4	26	25	250	2.95		40126	0.0604
614-6M	14	50	50	4.09		40127	0.1687
614-6MPK	14	50	50	4.23	✓	45650	0.1883
614-8L	14	50	50	5.11		40128	0.2481
615-213	24	10	100	9.02		40129	0.3000
615-214	24	10	100	9.47		40130	0.4896
615-233	24	10	100	9.64		40131	0.3090
615-234	24	10	100	9.60		40132	0.4893
615-C2113	54	25	25	16.30		49535	0.5660
615-C263	54	25	25	14.23		40133	0.4781
615-C264	54	25	25	14.33		40134	0.6631
616-02C	241	25	25	3.80	✓	50689	0.1147
616-02C8L	241	25	25	9.19	✓	50690	0.3539
616-02P	241	25	25	4.62	✓	50691	0.1680
616-02PN	241	1	25	10.26	✓	50692	0.1046
616-02RB	241	1	25	23.40	✓	40355	0.1046
616-02SN	241	1	25	9.90	✓	50693	0.1046
616-02W	241	25	25	4.35	✓	50694	0.1650
616-15	20	25	25	3.14		40135	0.1567
616-2	20	50	50	8.67		40136	0.4169
616-2E	20	50	50	3.78		40137	0.2133
616-2PK2	20	10	10	9.65		40162	0.4397
616-630	19	50	50	15.31		40138	0.8633
616-630X	19	50	50	19.10		40139	0.9339
616-630Y	19	50	50	17.82		40140	0.9150
616-648	19	12	12	18.74		40141	1.2009
616-650	19	25	25	20.37		40142	1.3911
616-650X	19	25	25	24.19		40143	1.4617
616-650Y	19	25	25	22.90		40144	1.4428
616-C2	51	50	50	11.09		40145	0.4776
616-C2PK	51	10	10	11.21	✓	49296	0.4999
616X1PX	36	50	50	11.31		48297	0.4455
616X2PX	36	50	50	10.93		48296	0.4435
616X2PXP2	36	20	20	11.08	✓	48294	0.4370
622-L06	13	100	100	1.88		40148	0.1331
622-L06PK	13	100	100	2.02	✓	40007	0.1394
622-L08	13	100	100	2.43		40149	0.1767
622-L08N	13	25	25	5.85		40151	0.1984
622-L08PK	13	100	100	2.57	✓	40009	0.1830
622-L08W	14	100	100	3.91		40123	0.1903
622-L09CF	24	25	25	9.24		40153	0.2856
622-L10	13	100	100	3.19		40154	0.2203
622-L12	13	100	100	3.58		40155	0.2653
622-L15	13	100	100	4.52		40156	0.3287
622-L18	13	100	100	5.26		40157	0.3980
622-L24	13	50	50	7.18		40159	0.5347
622-L24E	13	20	20	8.18		40160	0.6053
622-M06	13	100	100	1.47		49525	0.0983
622-M08	13	100	100	1.89	✓	40146	0.1304
622-M08PK	13	100	100	2.03		40008	0.1358
622-M10	13	100	100	2.47		40010	0.1625
622-M12	13	100	100	2.72		40165	0.1946
622-M12PK	13	100	100	2.86	✓	40012	0.1989
622-M15	13	100	100	3.34		40164	0.2422
622-M18	13	100	100	4.03		40168	0.2943
622-M24	13	50	50	5.60		40169	0.3956
623-L06	13	50	50	4.00		40170	0.2203
623-L08	13	50	50	5.06		40171	0.2956
623-L08D	14	50	50	6.83		49538	0.3000
623-L12	13	50	50	7.32		40172	0.4503
623-L12D	14	50	50	8.09		40173	0.4503
623-L15	13	50	50	8.96		40174	0.5682
623-L18	13	50	50	10.29		40175	0.6636
623-L18D	14	50	50	11.28		49539	0.6636
623-L24	13	50	50	15.23		40176	0.9494

A 10% surcharge will be applied to any item NOT purchased in multiples of the stated Minimum Quantity, except on drop ship orders. Items that are bold in the Min Qty column may NEVER be broken.

Item No.	Page No.	Min Qty	Case Qty	List Price	UPC Bar-Coded	UPC 5-Digit 739236	Weight (lbs)
623-L24D	14	50	50	16.10		49540	0.9494
623-M06	13	50	50	3.18		40177	0.1588
623-M08	13	50	50	3.96		40178	0.2129
623-M12	13	50	50	5.70		40179	0.3240
624-L08	13	30	30	7.44		40180	0.4306
624-L08D	14	30	30	8.54		40181	0.4378
624-L12	13	30	30	10.70		40182	0.6557
624-L12D	14	30	30	12.74		40183	0.6557
624-L15	13	30	30	13.17		40184	0.8271
624-L18	13	30	30	15.08		40185	0.9676
624-L18D	14	30	30	17.08		40186	0.9676
624-L24	13	30	30	20.92		40187	1.3824
624-L24D	14	30	30	22.24		40188	1.3824
629-06	15	100	100	4.27		40190	0.2382
629-12	15	50	50	7.43		40191	0.4639
629-L15	15	50	50	10.11		40192	0.5682
629-M	15	50	50	6.27		40193	0.3612
629-WCL	15	50	50	11.94		40194	0.7740
629-WCM	15	50	50	9.29		40195	0.5490
629-WCMPK	15	50	50	9.43	✓	45640	0.5490
630-C2412	50	50	50	7.38		40196	0.3620
630-C248	50	50	50	5.70		40197	0.2686
630-C248E	50	25	25	6.70		40198	0.3359
630-C248PK	50	10	10	5.84	✓	49073	0.2937
630-C287	50	50	50	6.70		40199	0.3454
630-C348	50	50	50	10.52		40161	0.5375
630-C3612	50	25	25	13.51		40602	0.7036
630-C41110	50	25	25	22.63		40033	1.1968
630W246E	34	25	25	6.39		49569	0.3240
630X146	34	50	50	3.37		40203	0.2014
630X148	34	50	50	3.85		40034	0.2426
630X148E	34	25	25	4.85		40036	0.3045
630X2138	34	50	50	7.62		40344	0.4601
630X2412	34	50	50	5.24		40037	0.3368
630X246	34	50	50	3.19		40343	0.2014
630X246E	34	25	25	4.13		40209	0.2606
630X246PK	34	20	20	3.33	✓	48092	0.2139
630X248	34	50	50	3.78		40211	0.2426
630X248E	34	25	25	4.78		49526	0.3018
630X248EPK	34	20	20	4.91		48096	0.3243
630X248N	34	25	25	8.33		40342	0.2686
630X248PK	34	20	20	3.91	✓	48094	0.2552
630X3136	34	50	50	11.08		40213	0.6660
630X3412	34	50	50	12.29		40035	0.5745
630X348	34	50	50	7.65		40215	0.4338
630X348E	34	25	25	8.65		40333	0.4942
631-305FP	20	25	25	21.82		40217	0.9902
631-33F	20	25	25	7.04		40331	0.2470
631-C307	52	25	25	12.06		40219	0.4578
631-C307FP	52	25	25	26.65		40332	1.1122
631WM0914E	38	10	10	25.75		40356	1.3079
631WM0914FPE	38	10	10	39.92		40357	2.0536
631WM0914RFE	38	10	10	39.92		49541	2.0536
631X02	37	25	25	6.11		40225	0.2638
631X02FP	37	12	12	22.48		40321	1.0586
631X06	37	25	25	8.74		40227	0.4034
631XM	38	25	25	9.82		40330	0.5694
631XM0914E	38	10	10	20.79		40358	1.1639
631XM0914FPE	38	10	10	34.61		40359	1.9085
631XS	38	50	50	7.80		40231	0.3262
632-C2123	51	50	50	6.70		40326	0.3415
632-C263	51	50	50	5.06		40233	0.2042
632-C263PK	51	10	10	5.21	✓	49146	0.2422
632-C263X	51	50	50	7.58		40327	0.2748
632-C263Y	51	50	50	6.36		40235	0.2559
632-C283	51	50	50	5.35		40253	0.2480

Item No.	Page No.	Min Qty	Case Qty	List Price	UPC Bar-Coded	UPC 5-Digit 739236	Weight (lbs)
632-C283PK	51	10	10	5.60	✓	49148	0.2732
632W273	36	50	50	6.32		40237	0.2578
632W273X	36	50	50	9.78		40238	0.3302
632WR11	45	5	50	9.88		40361	0.2705
632WR21	45	5	50	9.46		40362	0.2862
632X117	44	50	50	7.17		40239	0.1182
632X121M	44	50	50	5.32		40364	0.0521
632X122	43	100	1000	2.40		40240	0.0472
632X125	43	100	1000	2.40		40241	0.0492
632X125PK2	43	20	20	4.97		48730	0.1100
632X143	36	50	50	3.12		40242	0.1985
632X217	44	50	50	6.55		40243	0.1192
632X221M	44	50	50	5.08		40365	0.0521
632X221MPK2	44	10	10	5.15		48761	0.1873
632X222	43	100	1000	2.15		40244	0.0623
632X222M	44	50	50	5.25		48766	0.1238
632X222MPK2	44	10	10	5.45	✓	48764	0.1418
632X222PK2	43	20	20	4.47		48734	0.1100
632X225	43	100	1000	2.15		40246	0.0502
632X225PK2	43	20	20	4.47		48738	0.1200
632X232	43	50	50	3.18		40247	0.1049
632X232MPK2	44	10	10	7.92		48765	0.3854
632X243	36	50	50	2.48		40248	0.1438
632X243PK	36	20	20	2.62	✓	48146	0.1564
632X263	36	50	50	3.02		40249	0.1877
632X263X	36	50	50	6.83		40250	0.2583
632X263Y	36	50	50	5.57		40251	0.2394
632X332	43	25	250	2.89		40252	0.1011
632X332M	44	50	50	6.36		48778	0.1950
632X335	43	25	250	3.09		40254	0.1043
632X335PK2	43	20	20	6.35		48750	0.2300
632X3412	36	50	50	11.10		40255	0.5745
632X364	36	50	50	6.56		40256	0.3369
632XR11	45	5	50	9.43		40366	0.2738
632XR21	45	5	50	8.96		40369	0.2730
633-212	21	10	10	7.34		40257	0.3243
633-212FP	21	10	10	16.87		40258	0.7643
633-312	21	25	25	11.31		40259	0.5587
633-312C	21	25	25	18.23		40260	0.8011
633-312CFP	21	25	25	33.79		40261	1.4416
633-312FP	21	25	25	24.98		40262	1.1992
633-3TM11	22	25	25	20.32		40263	0.8568
633-3TM15	22	25	25	22.60		40264	0.9870
633-4312	21	25	25	17.77		40265	0.6746
633-4312FP	21	25	25	34.14		40266	1.4112
633-4TM11	22	25	25	30.98		40267	0.8079
633-4TM15	22	25	25	33.45		40268	1.1371
633-C02	52	50	50	6.23		40269	0.1983
633-C02PK	52	10	10	6.37	✓	49310	0.2112
633-C09	52	25	25	10.79		40270	0.4413
633-C09FP	52	25	25	24.87		40271	1.2026
633-C18	52	25	25	15.06		40272	0.7803
633-C18FP	52	25	25	29.21		40273	1.5154
633-C18FPM3	52	25	25	39.31		40274	1.7443
633-C18FPT	52	20	20	43.34		40275	1.7051
633-C18FRV	52	10	10	69.82		49571	2.2021
633-C18M3	52	25	25	24.83		40276	1.1002
633-C18PK	52	10	10	15.43	✓	49446	0.8886
633-C24	52	25	25	18.37		40277	0.9744
633-C24FP	52	25	25	32.32		40278	1.7273
633-C24FPT	52	20	20	46.47		40279	1.9486
633-C418	52	25	25	23.81		40280	0.8962
633-C418FP	52	25	25	37.40		40281	1.6432
633-C418FRV	52	10	10	73.39		49570	1.5022
633-C424	52	25	25	27.75		40283	1.1879
633-C424FP	52	25	25	40.41		40284	1.8552

Item No.	Page No.	Min Qty	Case Qty	List Price	UPC Bar-Coded	UPC 5-Digit 739236	Weight (lbs)
633-C4403	54	20	20	15.77		40286	0.4033
633X02	37	25	25	4.85		49543	0.1616
633X02PK	37	25	25	5.00	✓	48414	0.2825
633X18	37	25	25	13.90		40288	0.7534
633X18FP	37	25	25	28.26		40289	1.4981
633X18FPT	37	20	20	41.31		40290	1.6350
633X18FRV	79	10	10	68.52		49924	1.4981
633X18PK	37	25	25	14.12	✓	48446	0.6786
633X418	37	25	25	21.10		40291	0.8662
633X418FP	37	25	25	35.08		40292	1.5282
634-115	21	25	25	10.22		40293	0.5200
634-118	21	25	25	11.17		40294	0.6400
634-315	21	25	25	10.22		40297	0.4560
634-318	21	25	25	11.21		40298	0.5400
634-C118	53	25	25	17.71		40299	0.6223
634-C118FP	53	25	25	30.77		40300	1.3893
634X418	37	25	25	14.40		40301	0.5554
634X418FP	37	25	25	27.82		40590	1.2846
635-32	23	25	25	3.91		40303	0.1607
635-33	23	25	25	4.50		40304	0.2367
635-36	23	25	25	6.85		40591	0.5239
635-43	23	25	25	8.68		40306	0.3699
636-31305F	82	10	10	53.21		40307	2.4917
636-31308FK	82	10	10	99.68		40308	3.1317
636-3L10888	23	10	10	35.78		40309	1.6400
636-3TR	23	25	25	13.28		40311	0.6752
636-4L10888	23	10	10	49.95		40312	2.1600
636-C1307F2	82	10	10	77.45		40313	3.7121
636-C1310FK2	82	10	10	120.73		40314	4.3521
636-L3888	23	25	25	15.59		40315	0.8430
636X38883	39	12	12	34.48		40316	1.4420
636X3FPL	39	12	12	40.00		40317	2.0671
636X48884	39	12	12	42.43		40319	2.0071
637-C20	54	25	25	4.47		40320	0.1108
637-C20PK2	54	10	10	4.66	✓	49308	0.1331
637WR11	45	5	50	8.43		49519	0.1803
637WR21	45	5	50	7.90		49520	0.1960
637X10	45	50	50	1.41		48153	0.0447
637X10PK2	45	10	10	3.22	✓	48151	0.1116
637X15	45	50	500	2.36		48157	0.0585
637X20	45	50	500	1.09		48154	0.0423
637X20C	45	50	500	0.90		40324	0.0265
637X20PK2	45	10	10	2.58	✓	48152	0.1069
637X235	44	50	50	5.01		40325	0.1816
637X25	45	50	500	2.16		48158	0.0606
637X335	44	25	25	4.78		48790	0.1868
637X335PK2	44	10	10	4.72		49881	0.1868
637X410	45	50	500	2.10		40328	0.0531
637X413	45	50	50	3.48		40329	0.0986
637X420	45	50	50	2.01		48164	0.0567
637X423	45	50	50	3.37		48168	0.0986
637X711	42	50	50	6.63		40337	0.0964
637X721	42	50	50	6.54		40592	0.0963
637X920	47	25	250	10.24		40334	0.0935
637X920PK2	47	10	10	10.41		48540	0.1158
637X9220	47	25	250	11.15		48542	0.1238
637XR11	45	5	50	7.77		49521	0.1836
637XR21	45	5	50	7.30		49522	0.1827
638X208	35	100	100	3.06		40336	0.1767
638X208PK	35	20	20	3.24	✓	48130	0.1906
638X212	35	100	100	4.13		48132	0.2613
638X212E	35	50	50	5.27		49983	0.3187
638X312	35	50	50	8.80		40338	0.4503
638XT263	35	25	25	7.10		40339	0.2313
638XT283	35	25	25	7.66		40340	0.2725
640X01	41	100	1000	0.99		48262	0.0174

A 10% surcharge will be applied to any item NOT purchased in multiples of the stated Minimum Quantity, except on drop ship orders. Items that are bold in the Min Qty column may NEVER be broken.

Numerical Index

CATALOG 2007

NUMERICAL INDEX

NUMERICAL INDEX

NUMERICAL INDEX

NUMERICAL INDEX

NUMERICAL INDEX

Item No.	Page No.	Min Qty	Case Qty	List Price	UPC Bar-Coded	UPC 5-Digit 739236	Weight (lbs)
640X01PK2	41	20	20	2.34	✓	48260	0.0474
640X02	41	100	1000	0.94		48266	0.0233
640X02PK2	41	20	20	2.24	✓	48264	0.0593
640X03	41	100	1000	1.51		48270	0.0417
640X03PK2	41	20	20	3.35	✓	48268	0.0934
640X04	41	25	250	2.41		48271	0.0816
640X04PK2	41	20	20	5.18	✓	48269	0.1766
640X12	41	100	1000	0.58		40345	0.0064
640X13	41	100	1000	0.59		40346	0.0138
641-222	48	50	500	3.24		40347	0.0536
641-222X	44	50	50	4.60		40348	0.1504
641-222XPK2	44	10	10	4.78	✓	48668	0.1653
641-332	48	20	200	4.26		40349	0.0957
641-332X	44	50	50	5.49		48672	0.2378
641-333	48	20	200	4.50		40351	0.1094
641-333X	44	50	50	6.52		40352	0.2573
641-333XPK2	44	10	10	6.70	✓	48673	0.2716
641X111	40	50	500	3.60		48616	0.0671
641X111PK2	40	20	20	3.79	✓	48614	0.0807
641X222	40	50	500	2.11		48620	0.0650
641X222PK2	40	20	20	2.40	✓	48618	0.0784
641X223	40	20	200	3.65		48621	0.1385
641X223PK2	40	20	20	3.84	✓	48619	0.1519
641X322	40	20	200	3.25		48624	0.1286
641X322PK2	40	20	20	3.42	✓	48622	0.1144
641X323	40	20	200	3.25		48628	0.1227
641X323PK2	40	20	20	3.42	✓	48626	0.1361
641X332	40	20	200	3.25		48632	0.1275
641X332PK2	40	20	20	3.42	✓	48630	0.1409
641X333	40	20	200	3.23		48636	0.1401
641X333PK2	40	20	20	3.40	✓	48634	0.1535
641X334	40	20	200	8.32		40360	0.2328
641X432	40	20	200	11.21		48644	0.1983
641X433	40	20	200	8.42		48648	0.1976
641X434	40	20	20	8.42		40363	0.2258
641X442	40	20	200	8.23		48652	0.2145
641X443	40	20	200	8.23		48656	0.2100
641X443PK2	40	20	20	8.40	✓	48654	0.2271
641X444	40	20	200	8.23		48660	0.2248
641X444PK2	40	20	20	8.40	✓	48658	0.2419
642-2	48	25	250	2.07		40367	0.0368
642-3	48	25	250	2.69		40368	0.0851
642X1	40	25	250	1.49		48702	0.0312
642X1PK2	40	20	20	3.34	✓	48700	0.0684
642X2	40	25	250	1.15		48706	0.0426
642X23PK2	40	20	20	8.62	✓	48705	0.2251
642X2PK2	40	20	20	2.64	✓	48704	0.0957
642X3	40	25	250	1.56		48710	0.0877
642X3PK2	40	20	20	3.49	✓	48708	0.1861
642X4	40	25	25	4.81		48714	0.1734
642X4PK2	40	20	20	9.92	✓	48712	0.3844
643-2	48	100	1000	1.21		40370	0.0252
643-3	48	50	500	2.29		40371	0.0603
643-3B	48	50	50	2.43		40375	0.0648
643-C211	56	100	100	6.80		40376	0.2608
643-C311	56	50	50	9.60		40377	0.4389
643-C418	56	25	25	19.52		40378	1.0182
643X1	41	100	1000	1.30		48172	0.0282
643X11	41	100	1000	1.30		40380	0.0208
643X1PK2	41	20	20	2.97	✓	48170	0.0682
643X2	41	100	1000	0.65		48176	0.0262
643X202	41	50	500	1.40		40382	0.0458
643X208	35	100	100	3.06		40383	0.1740
643X212	35	100	100	4.14		40384	0.2613
643X23	41	50	100	1.41		48177	0.0341
643X23PK2	41	20	20	3.16	✓	48175	0.0792

A 10% surcharge will be applied to any item NOT purchased in multiples of the stated Minimum Quantity, except on drop ship orders. Items that are bold in the Min Qty column may NEVER be broken.

Item No.	Page No.	Min Qty	Case Qty	List Price	UPC Bar-Coded	UPC 5-Digit 739236	Weight (lbs)
643X2PK2	41	20	20	1.64	✓	48174	0.0642
643X3	41	50	500	1.20		48184	0.0524
643X32	41	50	500	1.74		48180	0.0528
643X32PK2	41	10	10	3.96	✓	48178	0.1243
643X34	41	25	250	2.67		40388	0.0866
643X3PK2	41	10	10	2.89	✓	48182	0.1240
643X4	41	25	250	3.09		48192	0.0873
643X43	41	25	250	2.65		40390	0.0846
644-2	48	100	1000	1.27		40391	0.0273
644-3	48	50	500	2.04		40392	0.0641
644X1	41	100	1000	1.31		48202	0.0282
644X1PK2	41	20	20	2.98	✓	48200	0.0682
644X2	41	100	1000	0.73		49527	0.0281
644X2PK2	41	20	20	1.81	✓	48204	0.0680
644X3	41	50	500	1.18		49528	0.0567
644X32	41	50	500	2.22		48210	0.0566
644X32PK2	41	10	10	4.81	✓	48208	0.1324
644X34	41	25	250	2.81		40397	0.0756
644X3PK2	41	10	10	2.73	✓	48212	0.1324
644X4	41	25	250	3.37		48226	0.0936
644X43	41	25	250	3.07		40399	0.0906
644X4PK2	41	5	5	7.80		48224	0.2207
645-2	48	100	1000	1.15		40400	0.0226
645-3	48	50	500	1.50		40401	0.0454
645-C2G	48	50	50	5.82		40411	0.0885
645-C3G	48	50	50	6.05		40410	0.1893
645WC2	43	50	50	5.72		40404	0.1259
645WC3	43	50	50	7.84		40405	0.2721
645WC4	43	20	20	14.52		40406	0.4674
645X1	39	100	1000	0.86		48232	0.0152
645X12PK2	39	20	20	4.06	✓	48231	0.1394
645X1PK2	39	20	20	2.07	✓	48230	0.0170
645X2	39	100	1000	0.65		48236	0.0234
645X2G	43	50	50	1.63		40409	0.0580
645X2GPK2	43	10	10	1.81	✓	48254	0.0593
645X2PK2	39	20	20	1.63	✓	48234	0.0590
645X3	39	50	500	0.80		48244	0.0382
645X32	39	50	500	1.60		48240	0.0369
645X32PK2	39	20	20	3.55	✓	48238	0.0848
645X3G	43	50	50	2.09		40412	0.0799
645X3GPK2	43	10	10	2.27	✓	48256	0.0767
645X3PK2	39	10	10	1.95	✓	48242	0.0955
645X4	39	25	250	2.04		48252	0.0688
645X43	39	25	250	2.44		48248	0.0595
645X43PK2	39	10	10	5.24	✓	48246	0.1414
645X4PK2	39	10	10	4.44	✓	48250	0.1535
645XC2	43	50	50	4.32		40415	0.0684
645XC2PK2	43	10	10	4.52	✓	48205	0.0908
645XC3	43	50	50	5.07		40416	0.1267
645XC3PK2	43	10	10	5.33	✓	48213	0.1493
645XC4	43	20	20	11.97		40417	0.3052
646-2	48	100	100	5.41		40418	0.0912
646-3	48	25	25	7.15		40419	0.3205
646-312	22	25	25	12.28		40420	0.7176
646-312C	22	25	25	19.06		40421	0.9600
646-312CFP	22	25	25	35.57		40422	1.6942
646-312FP	22	25	25	26.58		40423	1.4519
646-C2	55	50	50	4.26		40424	0.1264
646-C2PK2	55	10	10	4.44	✓	49312	0.1487
646-C3	53	50	50	5.56		40426	0.3802
646-C309	53	25	25	10.31		49568	0.4383
646-C309FP	53	25	25	21.31		49566	1.4123
646-C318	53	25	25	15.20		40427	0.9260
646-C318FP	53	25	25	28.76		40428	1.6853
646-C318FPPK	53	10	10	28.91	✓	49430	1.5976
646-C318FPT	53	20	20	43.27		40430	1.9433

Item No.	Page No.	Min Qty	Case Qty	List Price	UPC Bar-Coded	UPC 5-Digit 739236	Weight (lbs)
646-C318PK	53	10	10	15.36	✓	49428	0.8915
646-C324	53	25	25	19.26		40431	1.1556
646-C324FP	53	25	25	31.85		40432	1.8899
646-C324FPT	53	20	20	46.54		40433	2.1886
646-C3418	53	25	25	19.38		40434	0.8222
646-C3418FP	53	25	25	33.05		40435	1.6454
646-C3424	53	25	25	23.80		40437	1.0591
646-C3424FP	53	25	25	35.91		40438	1.8573
646-C3PK	53	10	10	5.68	✓	49320	0.4069
646-C4	55	20	20	10.99		40440	0.3697
646-C5	55	10	10	36.45		49985	0.0000
646-C6	55	10	10	48.90		49986	0.0000
646-C7	55	10	10	75.95		49987	0.0000
646-P3	60	50	50	8.46		40441	0.3940
646-P4	60	20	20	14.00		40442	0.3723
646-P4312FD	24	25	25	43.38		40443	1.7071
646-P4312FP	24	25	25	37.57		40444	1.6921
646-P4412FD	24	25	25	54.05		49523	1.9014
646-P4412FP	24	25	25	47.89		49524	1.8784
646-P5	60	10	10	18.65		49901	0.7599
646-P6	60	10	10	54.85		49988	0.0000
646-P7	60	10	10	72.65		49989	0.0000
646X12PK2	42	20	20	4.35	✓	48309	0.1234
646X2	42	100	100	2.62		49530	0.1082
646X23PK2	42	20	20	4.28	✓	48315	0.0934
646X2PK2	42	20	20	2.83	✓	48310	0.1194
646X3	42	25	250	3.81		49531	0.1758
646X318	38	25	25	15.04		40447	0.9316
646X318FP	38	25	25	28.51		40448	1.5936
646X32	42	50	50	4.40		48316	0.3086
646X32PK2	42	20	20	5.05	✓	48314	0.3177
646X34	42	25	25	5.11		40450	0.1867
646X3PK2	42	20	20	4.00	✓	48318	0.1824
646X4	42	50	50	9.34		48324	0.2789
646X43PK2	42	20	20	7.28	✓	48319	0.1694
646X4PK2	42	20	20	9.77	✓	48322	0.2911
647-2	48	50	50	6.19		40452	0.1153
647-3	48	50	50	8.54		40453	0.2062
647-C2	55	50	50	4.82		40454	0.1484
647-C2D	54	50	50	14.27		40455	0.2806
647-C2DPK2	54	10	10	14.47	✓	49322	0.3073
647-C2DW	54	50	50	13.83		40456	0.2926
647-C2DWPK2	54	10	10	14.00	✓	49324	0.3193
647-C2E	51	50	50	6.88		40457	0.2709
647-C2EPK2	51	10	10	7.06	✓	49292	0.2932
647-C2PK2	55	10	10	5.07	✓	49302	0.1707
647-C3	55	50	50	6.87		40458	0.2696
647-C3PK2	55	10	10	7.05	✓	49306	0.2963
647-C4	55	20	20	11.53		40459	0.4251
647-C5	55	10	10	34.20		49934	0.0000
647-C6	55	10	10	47.05		49935	0.0000
647-C7	55	10	10	72.90		49936	0.0000
647-P3	60	50	50	9.46		40460	0.2834
647-P4	60	20	20	16.14		40461	0.4276
647-P5	60	10	10	20.02		49900	0.0000
647-P6	60	10	10	57.00		49937	0.0000
647-P7	60	10	10	80.00		49938	0.0000
647X1E	36	50	50	5.60		48288	0.2407
647X1EPK2	36	20	20	5.76	✓	48286	0.2304
647X2	42	50	250	3.85		48302	0.1268
647X23E	36	50	50	6.73		48293	0.2462
647X23EPK2	36	20	20	6.90	✓	48291	0.2304
647X23PK2	42	10	10	5.78	✓	48301	0.2063
647X2E	36	50	50	4.72		49529	0.2409
647X2EPK2	36	20	20	4.99	✓	48290	0.2531
647X2PK2	42	10	10	4.03	✓	48300	0.1463

Item No.	Page No.	Min Qty	Case Qty	List Price	UPC Bar-Coded	UPC 5-Digit 739236	Weight (lbs)
647X3	42	50	50	4.76		48306	0.1944
647X3PK2	42	10	10	4.94	✓	48304	0.2124
647X4	42	50	50	10.30		48307	0.2998
647X4PK2	42	10	10	10.80	✓	48305	0.2381
648-2	46	10	10	14.75		40468	0.4358
648-3	46	10	10	24.90		40469	0.9249
648-82	29	10	10	15.79		49928	0.0000
648-83	29	10	10	22.87		49927	0.0000
648-84	29	10	10	39.95		49922	0.0000
648-C2FP	56	10	10	16.75		40470	0.5049
648-C2FPD	56	10	10	18.46		40471	0.5649
648-C2FPPK	56	10	10	16.86	✓	49500	0.5227
648-C2W	57	10	10	15.95		40473	0.6299
648-C3FP	56	10	10	22.50		40474	1.0577
648-C3FPD	56	10	10	28.75		40475	1.0727
648-C3W	57	10	10	20.90		40477	0.8697
648-C4FP	56	10	10	41.45		40478	1.6247
648-C4FPD	56	10	10	47.60		49567	1.5000
648-P3FP	60	10	10	23.75		40479	1.0824
648-P4FP	60	10	10	42.55		40480	1.6298
648X2	46	10	100	10.15		50695	0.2980
648X2FA	47	5	60	5.12		48532	0.1757
648X2FS	47	5	60	5.42		50697	0.2273
648X2W	46	12	12	11.80		50699	0.5588
648X3	46	10	100	14.94		50700	0.4430
648X3W	46	12	12	15.10		50702	0.7173
648X4FP	46	10	10	29.35		49534	1.3767
648X4FPPK	46	6	6	29.40		48504	1.4186
649-1	48	100	1000	0.241		40481	0.0103
649-2	48	100	1000	0.256		40482	0.0134
649-3	48	100	500	0.311		40483	0.0183
649-4	48	25	250	0.416		40484	0.0228
649X1	34	100	1000	0.224		48352	0.0111
649X1PK2	34	10	10	6.03	✓	48350	0.0380
649X2	34	100	1000	0.176		49532	0.0130
649X2PK2	34	10	10	5.25	✓	48354	0.3423
649X3	34	100	500	0.226		49533	0.0178
649X3PK2	34	10	10	6.08	✓	48358	0.4541
649X4	34	25	250	0.298		48364	0.0240
649X4PK2	34	10	10	3.35	✓	48362	0.2300
652-A	98	1	16	17.40		10752	0.6520
652-AD	102	1	16	18.40		10966	0.6520
652-AS	98	1	16	17.15		10702	0.6997
653-B	98	1	16	20.90		10753	0.9351
653-BS	98	1	16	20.40		10705	0.8445
654-C	98	1	16	50.90		10754	1.0320
654-CS	98	1	16	49.90		10708	1.0591
655-D	98	1	4	65.75		10755	2.0476
655-DS	98	1	4	64.75		10711	2.1446
656-E	98	1	4	87.75		10712	2.3756
656-ES	98	1	4	86.75		10714	2.4628
657-F	98	1	4	134.25		10715	2.7856
657-FD	102	1	4	134.25		10967	2.7856
657-FS	98	1	4	133.25		10717	2.9875
658-1503	100	1	1	1,250.00		10726	21.1829
658-2002	100	1	1	1,250.00		10733	21.6495
658-2004	100	1	1	1,315.00		10735	23.2261
658-4004	100	1	1	1,635.00		10741	34.9261
658-4004F2	100	1	1	1,815.00		10743	24.2526
658S2002	100	1	1	3,360.00		10750	13.6264
658S2004F2	100	1	1	3,920.00		10751	29.4572
658S4004F2	100	1	1	4,500.00		10756	34.9851
660-2	95	6	6	14.30	✓	10662	0.3529
660-2B	95	50	50	12.80		10601	0.2151
660-3SB	95	50	50	16.25		10603	0.2862
660-C	95	6	6	16.60	✓	10664	0.4200

A 10% surcharge will be applied to any item NOT purchased in multiples of the stated Minimum Quantity, except on drop ship orders. Items that are bold in the Min Qty column may NEVER be broken.

Numerical Index

CATALOG 2007

NUMERICAL INDEX

NUMERICAL INDEX

NUMERICAL INDEX

NUMERICAL INDEX

NUMERICAL INDEX

Item No.	Page No.	Min Qty	Case Qty	List Price	UPC Bar-Coded	UPC 5-Digit 739236	Weight (lbs)
660-CB	95	50	50	15.10		10605	0.2821
660-H	95	6	6	17.15	✓	10660	0.6982
660-HB	95	25	25	15.65		10607	0.4400
660-S	95	6	6	13.75	✓	10677	0.3787
660-SB	95	50	50	12.25		10609	0.2409
660-T	97	6	6	19.35	✓	10666	0.6603
660-T22	95	25	25	15.50		10611	0.2620
660-TA2B	97	25	25	18.95		10961	0.5529
660-TB	97	25	25	17.85		10612	0.5246
660-TC0	97	6	6	18.75	✓	10614	0.5887
660-TC0B	97	25	25	17.25		10615	0.4517
660-TC1	97	6	6	19.25	✓	10638	0.5783
660-TC1B	97	25	25	17.75		10613	0.4413
660-TC2	97	6	6	19.50	✓	10968	0.4860
660-TC2B	97	25	25	18.00		10969	0.4860
660-TK	95	6	6	21.45	✓	10616	0.6233
660-TKB	95	25	25	19.95		10618	0.4873
660-TR	97	6	6	19.15	✓	10672	0.6466
660-TR1	97	6	6	18.75	✓	10637	0.5815
660-TR1B	97	25	25	17.25		10621	0.4452
660-TR2	97	6	6	19.75	✓	10970	0.6118
660-TR2B	97	25	25	18.25		10971	0.5118
660-TRB	97	25	25	17.65		10622	0.5107
660-TS	96	25	25	18.50		10623	0.2834
660-TSF7	96	25	25	21.25		10996	0.5802
660-TSV7	96	25	25	21.75		10988	0.5207
660-TSX	96	25	25	22.50		10983	0.4365
660-TSX7	96	25	25	20.75		10989	0.5097
660-TW2	97	25	25	17.95		10626	0.4640
660-TX1	97	6	6	18.75	✓	10630	0.7749
660-TX1B	97	25	25	17.25		10629	0.6390
660-TX2	97	6	6	17.45	✓	10628	0.5167
660-TX2B	97	25	25	15.95		10627	0.4120
660-V2	95	6	6	16.40	✓	10650	0.3173
660-V2B	95	50	50	14.90		10651	0.1788
660-X2B	95	50	50	12.95		10631	0.1875
671X0430	85	25	25	19.45		40495	0.7462
671X0490	85	25	25	18.42		40496	0.6584
671X0630	85	25	25	25.22		40497	1.0253
671X0690	85	25	25	24.71		40498	0.9161
671X0830	85	25	25	31.32		40499	1.3095
671X0890	85	25	25	30.91		40500	1.2170
671X1030	85	25	25	38.05		40501	1.6022
671X1090	85	25	25	37.25		40502	1.4624
671X1230	85	25	25	46.33		40503	1.8138
671X1290	85	25	25	47.60		40504	1.8138
672C0242	91	1	10	35.29		49999	0.0000
672C0342	91	1	10	48.76		49998	0.0000
672C0442	91	1	10	62.17		49939	0.0000
672CB0242	91	1	10	72.81		49940	0.0000
672CB0342	91	1	10	104.26		49941	0.0000
672CB0442	91	1	10	132.39		49942	0.0000
672CV0242	91	1	10	43.16		49943	0.0000
672CV0342	91	1	10	61.80		49944	0.0000
672CV0442	91	1	10	78.47		49945	0.0000
672R0242	91	1	10	28.60		49946	0.0000
672R0342	91	1	10	38.72		49948	0.0000
672R0442	91	1	10	48.78		49949	0.0000
672RB0242	91	1	10	69.43		49950	0.0000
672RB0342	91	1	10	99.41		49951	0.0000
672RB0442	91	1	10	126.23		49952	0.0000
672RVO242	91	1	10	42.27		49953	0.0000
672RVO342	91	1	10	60.52		49954	0.0000
672RVO442	91	1	10	76.85		49955	0.0000
672X0242	90	1	10	16.84		49965	0.0000
672X0342	90	1	10	21.09		49966	0.0000

A 10% surcharge will be applied to any item NOT purchased in multiples of the stated Minimum Quantity, except on drop ship orders. Items that are bold in the Min Qty column may NEVER be broken.

Item No.	Page No.	Min Qty	Case Qty	List Price	UPC Bar-Coded	UPC 5-Digit 739236	Weight (lbs)
672X0390	86	25	25	14.03		40505	0.5211
672X0399	86	25	25	14.24		40506	0.5209
672X0430	86	25	25	17.07		40507	0.7324
672X0431PK	86	5	5	24.10	✓	48072	0.9754
672X0433EE	86	10	10	25.78		40508	1.1682
672X0441PK	86	5	5	24.67	✓	48082	0.9756
672X0442	90	1	10	25.18		49967	0.0000
672X0490	86	25	25	16.87		48032	0.6448
672X0490EE	86	10	10	26.00		40510	1.1682
672X0499	86	25	25	17.51		48012	0.6448
672X0590	86	25	25	20.35		40512	0.7856
672X0599	86	25	25	20.91		40513	0.7935
672X0630	86	25	25	23.08		40514	1.0048
672X0633EE	86	10	10	31.10		40515	1.4066
672X0690	86	25	25	22.71		48036	0.8958
672X0690EE	86	10	10	28.21		40517	1.4066
672X0699	86	25	25	23.34		40518	0.8958
672X0699PK	86	5	5	24.60	✓	48016	0.9600
672X0790	86	25	25	25.25		40519	1.0226
672X0830	86	25	25	28.45		40520	1.2822
672X0833EE	86	10	10	37.25		40521	1.7579
672X0890	86	25	25	27.78		40522	1.1901
672X0899	86	25	25	29.27		48018	1.1901
672X0930	86	25	25	30.86		40524	1.4109
672X0990	86	25	25	29.92		40525	1.2998
672X0999	86	25	25	31.93		40526	1.2998
672X1033EE	86	10	10	45.10		40527	2.0149
672X1090	86	25	25	32.30		40528	1.4285
672X1230	86	25	25	39.99		40529	1.7731
672X1233EE	86	10	10	51.24		40530	3.0547
672X1240	86	25	25	39.38		40531	1.7731
672X1290	86	25	25	40.70		48046	1.7731
672X1299	86	25	25	41.45		48022	1.7731
672X4L-1131B3	86	5	5	84.48		40534	3.8130
672XB0242	90	1	10	63.71		49968	0.0000
672XB0342	90	1	10	91.22		49969	0.0000
672XB0442	90	1	10	115.83		49970	0.0000
672XV0242	90	1	10	31.89		49971	0.0000
672XV0342	90	1	10	43.67		49972	0.0000
672XV0431PK	85	5	5	63.78	✓	48083	1.8586
672XV0442	90	1	10	55.46		49973	0.0000
672XV0490	85	1	10	57.53		40535	1.9397
672XV0499	85	1	10	58.75		40536	1.9720
672XV0590	85	1	10	70.55		40537	2.3495
672XV0599	85	1	10	71.87		40538	2.3946
672XV0690	85	1	10	84.60		40539	2.7677
672XV0699	85	1	10	86.37		40540	2.8262
672XV0699-2PK	85	5	5	98.70	✓	48017	2.7780
672XV0810	85	1	10	105.73		40541	3.4976
672XV1010	85	1	10	132.98		40542	4.3842
672XV1210	85	5	5	160.86		40543	5.1685
672XV1510	85	5	5	202.19		40544	7.3391
672XV1810	85	5	5	255.30		40545	8.5368
672XV3L-0431PK	85	5	5	62.11	✓	48073	1.9399
672XV4L-11313	85	5	5	193.08		40546	6.1294
675-20242	90	1	10	20.73		49974	0.0000
675-20244	88	10	10	20.63		40547	0.5344
675-20342	90	1	10	26.72		49975	0.0000
675-20344	88	10	10	26.62		40548	0.7307
675-20442	90	1	10	33.90		49976	0.0000
675-20444	88	10	10	33.80		40549	0.9269
675-20544	88	10	10	41.72		40550	1.1232
675-B20242	90	1	10	64.52		49977	0.0000
675-B20342	90	1	10	92.37		49978	0.0000
675-B20442	90	1	10	117.30		49979	0.0000
675-V20242	90	1	10	35.60		49980	0.0000

Item No.	Page No.	Min Qty	Case Qty	List Price	UPC Bar-Coded	UPC 5-Digit 739236	Weight (lbs)
675-V20244	88	1	10	35.50		40551	1.0147
675-V20342	90	1	10	48.84		49981	0.0000
675-V20344	88	1	10	48.74		40552	1.4347
675-V20442	90	1	10	62.24		49947	0.0000
675-V20444	88	1	10	62.24		40553	1.8547
675-V20544	88	1	10	76.09		40554	2.2747
677-11	91	1	10	23.72		49984	0.0000
67745L-08334	87	5	5	92.74		40555	4.6767
678-20242	87	10	10	13.05		40556	0.4056
678-20342	87	10	10	16.91		40557	0.5374
678-20344	87	10	10	16.82		40558	0.5374
678-20442	87	10	10	21.30		40559	0.6692
678-20644	87	10	10	29.97		40560	0.9401
678-21244	87	10	10	56.02		40561	1.8093
6784L-11313	87	5	5	63.95		40562	3.1345
6795L-12333	87	5	5	110.42		40563	4.9200
6796L-12333	87	5	5	122.95		40564	5.4600
6797L-12333	87	5	5	156.32		40565	7.2400
679X102299	87	10	10	45.64		40566	1.8622
679X152190	87	10	10	24.48		40567	0.9269
679X152199	87	10	10	25.38		40568	0.9269
679X172199	87	10	10	32.64		40569	1.2624
682-L5113	18	25	25	9.77		40571	0.3795
682-L5140	18	25	25	11.68		40572	0.5361
682-M5113	18	25	25	8.55		40573	0.2928
682-M5140	18	25	25	10.52		40574	0.4494
682XL5213	35	25	25	10.42		40575	0.4103
682XL5240	35	25	25	12.31		40576	0.5578
682XL5240PK	35	10	10	12.58	✓	48804	0.6284
683-M5113	18	25	25	11.57		40577	0.4536
683-M5140	18	25	25	13.67		40578	0.6100
683XM5213	35	25	25	12.62		40579	0.4921
690-0101	82	1	1	101.82		49565	3.9568
690-2020	82	1	1	109.35		49564	4.1000
692-1308	24	25	25	19.23		40580	0.7199
693-01020402		12	12	34.80		49554	2.2213
693-01024102	72	12	12	42.76		40581	2.8162
693-01035104		12	12	31.93		49549	3.0675
693-02016403	72	12	12	47.73		40583	3.9430
693-06020403		12	12	41.38		49553	3.1830
693-06024203	72	12	12	54.43		40584	3.5917
693-13045301		12	12	43.01		49547	4.6478
693-13155301	68	12	12	38.35		49548	3.3770
693-14155303	68	12	12	40.03		49546	4.1007
693-32434403	72	12	12	50.27		49555	4.4727
694-211120	76	10	10	37.79		40585	1.7199
694-211123	76	10	10	44.79		40586	2.1470
694C33012091		10	10	65.81		49557	2.8868
694C33012093		10	10	63.53		49558	2.7582
694C33012391		10	10	72.81		49562	3.3154
694C33012393		10	10	70.53		49662	3.1868
694C331220		10	10	45.77		40587	2.1997
694C36012092		10	10	85.41		49561	3.1222
694C36012094		10	10	82.94		49559	2.7977
694C36012492		10	10	100.31		49563	3.9585
694C361520		10	10	62.71		49560	2.5516
695-01	103	1	24	56.75		10900	1.2600
695-D20	104	1	16	17.30		10901	0.6540
695-D30	104	1	16	19.00		10902	0.7493
695-D40	104	1	16	21.25		10903	0.4628
695-D432	104	1	16	21.25		10904	0.4628
695-D4325	104	1	16	21.75		10905	0.4628
695-D432F	104	1	10	31.75		10504	0.8392
695-Y52	104	1	10	31.75		10906	0.8942
696-1	308	10	10	5.00		10907	0.7404
696-1000AF	307	10	10	18.00		10908	1.2489

Item No.	Page No.	Min Qty	Case Qty	List Price	UPC Bar-Coded	UPC 5-Digit 739236	Weight (lbs)
696-1000AR	307	10	10	16.50		10909	0.9184
696-1000CF	307	10	10	17.10		10910	1.2000
696-1000CR	307	10	10	15.60		10911	1.0582
696-1000KF	307	10	10	17.50		10912	1.2170
696-1000KR	307	10	10	16.00		10913	0.9184
696-1000MF	307	10	10	16.20		10914	1.2000
696-1000MFPK4	307	5	5	22.25	✓	10974	1.2000
696-1000MR	307	10	10	14.70		10915	0.9184
696-1000PF	307	10	10	19.30		10976	0.7358
696-1000WF	307	10	10	16.75		10916	1.3000
696-1000WR	307	10	10	15.25		10917	1.1442
696-1000XF	307	10	10	16.65		10918	1.1670
696-1000XR	307	10	10	15.15		10919	0.9184
696-1010AF	307	10	10	38.30		10920	1.0030
696-1010AR	307	10	10	36.80		10921	0.9192
696-1010CF	307	10	10	37.40		10922	1.0030
696-1010CR	307	10	10	35.90		10923	0.9192
696-1010CR26	309	10	10	36.40		10990	0.9192
696-1010KF	307	10	10	37.80		10924	1.0030
696-1010KR	307	10	10	36.30		10925	0.9192
696-1010MF	307	10	10	36.50		10926	1.4032
696-1010MR	307	10	10	35.00		10927	1.3184
696-1010MR26	309	10	10	35.50		10991	1.3184
696-1010WF	307	10	10	37.05		10928	1.3920
696-1010WR	307	10	10	35.55		10929	0.9192
696-1010XF	307	10	10	36.95		10930	1.0030
696-1010XR	307	10	10	35.45		10931	1.3129
696-1010XR26	309	10	10	35.95		10992	1.3129
696-1F	308	10	10	1.50		10932	0.0838
696-2	308	10	10	5.00		10933	0.7287
696-2303AF	306	10	10	34.55		10934	2.4780
696-2303AR	306	10	10	32.55		10935	1.6638
696-2303CF	306	10	10	32.75		10936	2.2160
696-2303CR	306	10	10	30.75		10937	1.6485
696-2303CR00	306	10	10	28.50		10987	1.1958
696-2303KF	306	10	10	33.55		10938	2.3898
696-2303KR	306	10	10	31.55		10939	1.6639
696-2303MF	306	10	10	30.95		10940	2.4140
696-2303MFPK4	306	4	4	47.74	✓	10973	2.9250
696-2303MR	306	10	10	28.95		10941	1.6639
696-2303MR00	306	10	10	26.70		10986	1.2112
696-2303PF	306	10	10	37.55		10972	2.5430
696-2303WF	306	10	10	32.05		10942	2.5000
696-2303WR	306	10	10	30.05		10943	2.2267
696-2303XF	306	10	10	31.85		10944	2.4080
696-2303XR	306	10	10	29.85		10945	2.2134
696-2313AF	306	10	10	59.60		10946	1.8800
696-2313AR	306	10	10	57.60		10947	1.6972
696-2313CF	306	10	10	57.80		10948	2.6600
696-2313CR	306	10	10	55.80		10949	2.4361
696-2313CR00	306	10	10	53.55		10985	1.2292
696-2313CR26	306	10	10	56.30		10993	2.4361
696-2313KF	306	10	10	58.60		10950	2.7778
696-2313KR	306	10	10	56.60		10951	2.5904
696-2313MF	306	10	10	56.00		10952	2.7840
696-2313MR	306	10	10	54.00		10953	2.6000
696-2313MR0	306	10	10	53.75		10975	2.4020
696-2313MR00	306	10	10	51.75		10984	2.0040
696-2313MR26	306	10	10	54.50		10994	2.6000
696-2313WF	306	10	10	57.10		10954	2.8000
696-2313WR	306	10	10	55.10		10955	2.6301
696-2313XF	306	10	10	56.90		10956	2.7900
696-2313XR	306	10	10	54.90		10957	2.5880
696-2313XR26	306	10	10	55.40		10995	2.5880
696-2F	308	10	10	2.00		10958	0.1828
696-3	308	10	10	5.00		10959	0.4104

A 10% surcharge will be applied to any item NOT purchased in multiples of the stated Minimum Quantity, except on drop ship orders. Items that are bold in the Min Qty column may NEVER be broken.

Numerical Index

CATALOG 2007

Item No.	Page No.	Min Qty	Case Qty	List Price	UPC Bar-Coded	UPC 5-Digit 739236	Weight (lbs)	Item No.	Page No.	Min Qty	Case Qty	List Price	UPC Bar-Coded	UPC 5-Digit 739236	Weight (lbs)
696-BC	308	10	10	2.00		10960	0.2785	801-APK	181	10	10	5.08	✓	30034	0.3326
696-CF	308	10	10	10.00		10997	0.0000	801-N	181	1	1	41.50	✓	30038	1.1412
696-PN	308	50	50	0.35		10979	0.0083	801-NER	181	1	1	12.50	✓	30011	0.4644
700-0	285	12	120	1.98		50704	0.0750	801-P	181	1	1	4.96	✓	30012	0.3340
700-1	285	12	120	1.98		50705	0.0800	801-PPK	181	10	10	5.08	✓	30032	0.3376
700-2	285	12	120	1.98		50706	0.0930	802-7	159	12	12	5.12	✓	30002	0.1089
700-3	285	12	120	2.05		40373	0.0960	803-2PK2	187	12	12	33.75	✓	30005	0.2423
700-4	285	12	120	2.25		40374	0.1050	803-3PK2	187	12	12	22.50	✓	30006	0.5934
700-5	285	6	60	2.45		50709	0.1110	803-4PK2	187	12	12	25.00	✓	30007	1.0860
700-6	285	6	60	2.70		50710	0.1360	821-200A	154	20	20	9.95	✓	30014	1.1662
700-7	285	6	60	3.10		50711	0.1580	821-200ABQ	155	1	5	58.50	✓	35638	2.3754
701-2	285	12	120	2.00		50712	0.0930	821-200ABR	155	1	5	44.25	✓	35164	1.9254
701-3	285	12	120	2.10		50713	0.0930	821-200ANQ	155	1	5	45.00	✓	35637	3.1329
701-4	285	12	120	2.32		50714	0.0930	821-200ANR	155	5	5	35.00	✓	30193	1.5504
702-2	285	24	240	1.32		50715	0.0530	821-200AP	154	20	20	17.00	✓	35228	1.1573
702-3	285	24	240	1.36		50716	0.0550	821-200APK	154	8	8	11.22	✓	30164	1.1275
702-4	285	24	240	1.58		50717	0.0640	821-200ARBQ	155	1	5	108.50	✓	35231	3.1296
703-2	285	24	240	1.36		50718	0.0540	821-200ARBR	155	1	5	71.50	✓	35232	1.4466
703-3	285	24	240	1.44		50719	0.0560	821-200P	154	20	20	9.95	✓	30017	1.2756
703-4	285	24	240	1.74		50720	0.0630	821-200PBQ	155	1	5	58.50	✓	30197	2.5854
703-5	285	12	120	2.42		50721	0.1130	821-200PBR	155	1	5	44.25	✓	30194	2.1354
703-6	285	6	60	2.62		50722	0.1350	821-200PNQ	155	1	5	45.00	✓	30196	2.4300
703-7	285	6	60	2.94		50723	0.1470	821-200PNR	155	5	5	35.00	✓	30192	1.7604
704-2	285	12	120	2.10		50724	0.0960	821-200PP	154	20	20	17.00	✓	30162	1.3723
704-3	285	12	120	2.18		50725	0.0960	821-200PPK	154	8	8	11.22	✓	30160	1.2933
704-4	285	12	120	2.45		50726	0.0980	821-200PRBQ	155	1	5	108.50	✓	35233	3.3274
705-2	285	12	120	4.60		50727	0.1100	821-200PRBR	155	1	5	71.50	✓	35234	1.6599
705-3	285	12	120	4.78		50728	0.1270	821-2080A	154	20	20	10.45	✓	30022	1.1821
705-4	285	12	120	4.82		50729	0.1220	821-2080P	154	20	20	10.45	✓	30023	1.3889
706-2	285	6	60	1.32		50730	0.0420	821-270A	154	20	20	9.20	✓	35156	1.0744
706-3	285	6	60	1.36		50731	0.0440	821-270P	154	20	20	9.20	✓	30024	1.2669
706-4	285	6	60	1.78		50732	0.0500	821-2780A	154	1	10	9.70	✓	30025	1.1072
707-2	285	6	60	1.39		50733	0.0430	821-2780P	154	1	10	9.70	✓	30026	1.3172
707-3	285	6	60	1.44		50950	0.0500	821-280A	154	20	20	9.95	✓	35237	1.1264
707-4	285	6	60	1.54		50735	0.0500	821-280P	154	20	20	9.95	✓	30030	1.2679
710-2	286	6	120	4.78		40402	0.0580	821-2A	154	20	20	9.25	✓	30041	1.1584
710-3	286	6	120	5.36		40403	0.0850	821-2ABP	155	1	5	36.00	✓	35238	1.6000
710-4	286	6	120	6.08		50738	0.1000	821-2ACP	155	1	5	30.75	✓	30033	1.7302
730-05	286	1	24	8.34	✓	40596	0.3080	821-2P	154	20	20	9.25	✓	30035	1.2679
730-10	286	1	24	11.89	✓	40302	0.5680	821-2PBP	155	1	5	36.00	✓	30036	1.7965
730-25	286	1	12	28.28	✓	40597	1.1000	821-2PCP	155	1	5	30.75	✓	30037	1.8959
740-02	286	1	50	1.80	✓	40601	0.0840	821-2RB	182	1	1	28.00	✓	30052	0.1753
740-05	286	1	24	3.19	✓	40598	0.2360	821-2S	182	1	1	2.75	✓	30039	0.2219
740-10	286	1	24	5.95	✓	40305	0.4260	821-2SB	182	1	10	18.50	✓	35152	0.5495
740-25	286	1	12	13.28	✓	40595	0.9420	821-2SN	182	1	10	19.10	✓	35158	0.5264
743-05	286	1	24	4.62	✓	40599	0.3640	821-2SNRPK1	182	6	6	28.93	✓	31542	0.8831
743-10	286	1	24	8.26	✓	40335	0.5680	821-2SP	182	1	1	8.75	✓	30040	0.1699
743-25	286	1	12	19.62	✓	40600	1.1900	821-2SPK1	182	10	10	3.93	✓	30090	0.2291
750-46	287	1	14	8.60		50749	0.3860	821-2SPPK1	182	10	10	9.93	✓	30092	0.1871
750-69	287	1	12	7.30		50750	0.3580	821-2SRB	182	1	10	53.60	✓	31543	0.5264
752-69	287	1	12	4.74		50751	0.3170	821-2SRBRPK1	182	6	6	67.68	✓	31544	0.5264
771	287	1	12	18.61		50752	2.1330	821-2SW	182	1	1	8.50	✓	30094	0.1629
772	287	1	12	23.86		50753	2.4330	821-2SZ	182	1	1	4.75	✓	36708	0.1865
773	287	36	360	1.43		50754	0.0360	821-HBP	155	1	5	28.75	✓	35159	0.8346
774	287	36	36	1.84		50755	0.0560	821-HCP	155	1	5	28.25	✓	35160	0.9108
776	287	24	24	2.69		50756	0.0710	825-10A	156	20	20	7.75	✓	35624	0.5723
777	287	24	24	3.21		50757	0.0790	825-10P	156	20	20	7.75	✓	35625	0.7013
800-A	159	12	12	21.00	✓	30010	2.4307	825-17A	156	20	20	6.35	✓	35626	0.5826
800-ABW	159	12	12	28.00	✓	30013	2.4991	825-17P	156	20	20	6.35	✓	35627	0.6939
800-ANR	159	1	2	74.00	✓	35620	4.9642	825-1A	156	20	20	6.50	✓	35628	0.3250
800-APK	159	3	3	22.20	✓	30010	2.8441	825-1P	156	20	20	6.50	✓	35629	0.6989
800-P	159	12	12	21.00	✓	30008	3.1369	825-20A	156	20	20	7.75	✓	30042	0.5723
800-PBW	159	12	12	28.00	✓	30015	3.2066	825-20P	156	20	20	7.75	✓	30043	0.7013
800-PNR	159	1	2	74.00	✓	30676	5.7168	825-27A	156	20	20	6.35	✓	30044	0.5826
800-PPK	159	3	3	22.20	✓	30008	3.4308	825-27P	156	20	20	6.35	✓	30045	0.6939
801-A	181	1	1	4.96	✓	30009	0.3290	825-27PP	156	1	5	13.25	✓	30046	0.7019

A 10% surcharge will be applied to any item NOT purchased in multiples of the stated Minimum Quantity, except on drop ship orders. Items that are bold in the Min Qty column may NEVER be broken.

Item No.	Page No.	Min Qty	Case Qty	List Price	UPC Bar-Coded	UPC 5-Digit 739236	Weight (lbs)	Item No.	Page No.	Min Qty	Case Qty	List Price	UPC Bar-Coded	UPC 5-Digit 739236	Weight (lbs)
825-2A	156	20	20	6.50	✓	30047	0.5875	832-4DNO	111	1	1	120.00		37613	0.0000
825-2AB	182	1	1	30.00	✓	30571	0.1633	832-4DNR	111	1	1	104.00		37614	0.0000
825-2AFS	158	10	10	10.75	✓	30157	0.7066	832-4HBO	130	1	1	74.75		37406	2.9556
825-2APK	156	12	12	6.63	✓	30154	0.6051	832-4HBR	130	1	1	57.50		37407	2.0366
825-2P	156	20	20	6.50	✓	30049	0.6989	832-4HNQ	130	1	1	63.25		37408	3.0046
825-2PFS	158	10	10	10.75	✓	30155	0.8826	832-4HNR	130	1	1	47.50		37390	2.0046
825-2PP	156	1	5	13.50	✓	30152	0.7045	832-4PBQ	112	1	1	95.50		37455	5.1308
825-2PPK	156	12	12	6.63	✓	30150	0.7165	832-4PBR	112	1	1	78.25		37430	4.1733
825-2SC	182	1	1	30.00	✓	30613	0.1633	832-4PF	112	1	1	19.75		37436	1.6016
825-2SN	182	1	1	30.00	✓	30615	0.1633	832-4PNQ	112	1	1	84.00		37454	5.1712
826-2A	158	1	20	15.50	✓	30182	0.5120	832-4PNR	112	1	1	68.25		37440	4.1712
826-2P	158	1	20	15.50	✓	35223	0.5888	826-S4	128	1	10	9.00		37382	0.0522
826-2PPK	158	10	10	15.63	✓	30180	0.6226	833-22BQ	129	1	1	130.75		37483	11.6925
826-2S	182	1	1	5.00		30184	0.1904	833-22BR	129	1	1	113.50		37484	10.8615
826-2SP	182	1	1	17.85		30186	0.2304	833-22DF	128	1	1	86.00		37615	0.0000
827-2AB	182	1	1	26.50	✓	35646	0.1562	833-22DiR	128	1	1	143.00		37616	0.0000
827-2ABPK1	182	6	6	27.68	✓	31539	0.2737	833-22DNQ	128	1	1	166.00		37617	0.0000
827-2B	157	1	10	20.45	✓	30176	1.7957	833-22DNR	128	1	1	150.00		37618	0.0000
827-2BG	157	1	10	1.75		30057	0.0111	833-22F	129	1	1	55.00		37485	8.2898
827-2BLN	157	1	10	5.68		30058	0.0271	833-22NQ	129	1	1	119.25		37486	11.8594
827-2BN	157	1	10	4.00		30059	0.0255	833-22NR	129	1	1	103.50		37487	10.8594
827-2BP	157	1	10	26.47	✓	30178	1.7571	833-23BQ	129	1	1	130.75		37488	9.9415
827-2J	157	1	6	32.00	✓	30204	2.2107	833-23BR	129	1	1	113.50		37489	9.1105
827-2RB	182	1	1	26.50	✓	37438	0.1554	833-23DF	128	1	1	86.00		37619	0.0000
827-2RBPK1	182	6	6	27.68	✓	31536	0.2750	833-23DiR	128	1	1	143.00		37620	0.0000
827-2S	182	1	1	2.50	✓	30064	0.2058	833-23DNQ	128	1	1	166.00		37621	0.0000
827-2SA	182	1	1	8.50	✓	35239	0.2125	833-23DNR	128	1	1	150.00		37622	0.0000
827-2SC	182	1	1	26.50	✓	35644	0.1562	833-23F	129	1	1	55.00		37490	6.5388
827-2SN	182	1	1	26.50	✓	35645	0.1562	833-23NQ	129	1	1	119.25		37491	10.1084
827-2SNPK1	182	6	6	27.68	✓	31538	0.2667	833-23NR	129	1	1	103.50		37492	9.1084
827-2SP	182	1	1	8.50	✓	30065	0.1726	833-24BQ	129	1	1	130.50		37493	11.4415
827-2SPK1	182	10	10	3.68	✓	30174	0.2260	833-24BR	129	1	1	113.50		37494	10.6105
827-2SPPK1	182	10	10	9.68	✓	30175	0.1873	833-24DF	128	1	1	86.00		37623	0.0000
827-2SW	182	1	1	8.00	✓	35648	0.1554	833-24DiR	128	1	1	143.00		37624	0.0000
827-2SWPK1	182	6	6	9.18	✓	31541	0.2751	833-24DNQ	128	1	1	166.00		37625	0.0000
827-2SZ	182	1	1	4.75	✓	35647	0.2271	833-24DNR	128	1	1	150.00		37626	0.0000
828-2	157	1	20	8.00	✓	30067	0.6066	833-24F	129	1	1	55.00		37388	8.0388
828-2P	157	1	20	13.75	✓	30173	0.5679	833-24NQ	129	1	1	119.25		37495	11.6084
828-2PK	157	10	10	8.13	✓	30171	0.6346	833-24NR	129	1	1	103.50		37497	10.6084
829-2A	156	20	20	10.00	✓	30069	0.5128	833-24BQ	130	1	1	111.25		37498	6.8417
829-2P	156	20	20	10.00	✓	30055	0.6218	833-2ABR	130	1	1	94.00		37499	6.0107
829-S2	158	1	20	16.00	✓	30071	0.6506	833-2AF	130	1	1	35.50		37500	3.4390
832-36ABQ	112	1	1	94.50		37479	4.7142	833-2ANQ	130	1	1	99.75		37501	7.0086
832-36ABR	112	1	1	77.25		37473	3.8832	833-2ANR	130	1	1	84.00		37502	6.0086
832-36AF	112	1	1	18.75		37467	1.3115	833-2PBQ	130	1	1	111.25		37503	7.1267
832-36ANQ	112	1	1	83.00		37480	4.8811	833-2PBR	130	1	1	94.00		37456	6.2975
832-36ANR	112	1	1	67.25		37472	3.8814	833-2PF	130	1	1	35.50		37432	3.7240
832-36PBQ	112	1	1	94.50		37431	4.8676	833-2PNQ	130	1	1	99.75		37505	7.2936
832-36PBR	112	1	1	77.25		37429	4.0366	833-2PNR	130	1	1	84.00		37443	6.2936
832-36PF	112	1	1	18.75		37422	1.4649	833-3ABQ	130	1	1	111.25		37508	7.0067
832-36PNQ	112	1	1	83.00		37453	5.0345	833-3ABR	130	1	1	94.00		37509	6.1757
832-36PNR	112	1	1	67.25		37446	4.0345	833-3AF	130	1	1	35.50		37510	3.6040
832-3DF	111	1	1	37.00		37604	0.0000	833-3ANQ	130	1	1	99.75		37511	7.1736
832-3DiR	111	1	1	94.00		37605	0.0000	833-3ANR	130	1	1	84.00		37512	6.1736
832-3DNQ	111	1	1	117.00		37606	0.0000	833-3PBQ	130	1	1	111.25		37513	7.1917
832-3DNR	111	1	1	101.00		37607	0.0000	833-3PBR	130	1	1	94.00		37457	6.3610
832-4ABQ	112	1	1	95.50		37481	4.8479	833-3PF	130	1	1	35.50		37387	3.7890
832-4ABR	112	1	1	78.25		37478	4.0169	833-3PNQ	130	1	1	99.75		37507	7.3586
832-4AF	112	1	1	19.75		37466	1.4452	833-3PNR	130	1	1	84.00		37423	6.3586
832-4ANQ	112	1	1	84.00		37482	5.0148	833-4ABQ	130	1	1	111.25		37514	7.0566
832-4ANR	112	1	1	68.25		37474	4.0148	833-4ABR	130	1	1	94.00		37515	6.2257
832-4DF	111	1	1	40.00		37608	0.0000	833-4AF	130	1	1	35.50		37516	3.6540
832-4DHiR	128	1	1	56.00		37609	0.0000	833-4ANQ	130	1	1	99.75		37517	7.2236
832-4DHNO	128	1	1	79.00		37610	0.0000	833-4ANR	130	1	1	84.00		37518	6.2236
832-4DHNR	128	1	1	63.00		37611	0.0000	833-4PBQ	130	1	1	111.25		37519	7.1817
832-4DiR	111	1	1	97.00		37612	0.0000	833-4PBR	130	1	1	94.00		37458	6.3507

NUMERICAL INDEX

NUMERICAL INDEX

NUMERICAL INDEX

NUMERICAL INDEX

NUMERICAL INDEX

Numerical Index

CATALOG 2007

NUMERICAL INDEX

NUMERICAL INDEX

NUMERICAL INDEX

NUMERICAL INDEX

NUMERICAL INDEX

Item No.	Page No.	Min Qty	Case Qty	List Price	UPC Bar-Coded	UPC 5-Digit 739236	Weight (lbs)
833-4PF	130	1	1	35.50		37435	3.7790
833-4PNQ	130	1	1	99.75		37548	7.3486
833-4PNR	130	1	1	84.00		37424	6.3486
833-62BQ	129	1	1	133.75		37521	10.2115
833-62BR	129	1	1	116.50		37522	9.3805
833-62DF	128	1	1	89.00		37627	0.0000
833-62DiR	128	1	1	146.00		37628	0.0000
833-62DNQ	128	1	1	169.00		37629	0.0000
833-62DNR	128	1	1	153.00		37630	0.0000
833-62F	129	1	1	58.00		37523	6.8088
833-62NQ	129	1	1	122.25		37524	10.3784
833-62NR	129	1	1	106.50		37526	10.9505
833-63BQ	129	1	1	133.75		37527	11.9505
833-63BR	129	1	1	116.50		37506	10.9505
833-63DF	128	1	1	89.00		37631	0.0000
833-63DiR	128	1	1	146.00		37632	0.0000
833-63DNQ	128	1	1	169.00		37633	0.0000
833-63DNR	128	1	1	153.00		37634	0.0000
833-63F	129	1	1	58.00		37426	8.3788
833-63NQ	129	1	1	122.25		37525	11.9484
833-63NR	129	1	1	106.50		37528	11.1614
833-64BQ	129	1	1	133.75		37529	11.8984
833-64BR	129	1	1	116.50		37530	11.1114
833-64DF	128	1	1	89.00		37635	0.0000
833-64DiR	128	1	1	146.00		37636	0.0000
833-64DNQ	128	1	1	169.00		37637	0.0000
833-64DNR	128	1	1	153.00		37638	0.0000
833-64F	129	1	1	58.00		37470	8.5918
833-64NQ	129	1	1	122.25		37531	12.1614
833-64NR	129	1	1	106.50		37437	11.1614
834-3ABQ	141	1	1	112.00		37532	5.6539
834-3ABR	141	1	1	90.50		37533	4.8229
834-3AF	141	1	1	21.75		37468	1.4112
834-3ANQ	141	1	1	102.00		37534	5.6573
834-3ANR	141	1	1	73.00		37535	4.2608
834-3ATQ	141	1	1	70.50		37536	3.6808
834-3ATR	141	1	1	58.00		37537	3.3708
834-3DF	140	1	1	40.00		37639	0.0000
834-3DiR	140	1	1	97.00		37640	0.0000
834-3DNQ	140	1	1	134.00		37641	0.0000
834-3DNR	140	1	1	114.00		37642	0.0000
834-3PBQ	141	1	1	112.50		37434	5.8073
834-3PBR	141	1	1	90.50		37460	4.9763
834-3PF	141	1	1	21.75		37421	1.5655
834-3PNQ	141	1	1	102.00		37462	5.8107
834-3PNR	141	1	1	73.00		37419	4.4151
834-3PTQ	141	1	1	70.50		35738	3.8342
834-3PTR	141	1	1	58.00		37418	3.5242
834-4ABQ	141	1	1	113.00		37539	5.7673
834-4ABR	141	1	1	91.50		37540	5.1363
834-4AF	141	1	1	22.75		37469	1.5246
834-4ANQ	141	1	1	103.00		37541	5.7707
834-4ANR	141	1	1	74.00		37542	4.3742
834-4ATQ	141	1	1	71.50		37543	3.7942
834-4ATR	141	1	1	59.00		37544	3.4842
834-4DF	140	1	1	43.00		37643	0.0000
834-4DHiR	140	1	1	56.00		37644	0.0000
834-4DHNQ	140	1	1	93.00		37645	0.0000
834-4DHNR	140	1	1	73.00		37646	0.0000
834-4DiR	140	1	1	100.00		37647	0.0000
834-4DNQ	140	1	1	137.00		37648	0.0000
834-4DNR	140	1	1	117.00		37649	0.0000
834-4HBQ	141	1	1	89.25		37433	3.7900
834-4HBR	141	1	1	67.75		37420	2.9646
834-4HNQ	141	1	1	79.25		37416	3.6811
834-4HNR	141	1	1	50.25		37391	2.2846

A 10% surcharge will be applied to any item NOT purchased in multiples of the stated Minimum Quantity, except on drop ship orders. Items that are bold in the Min Qty column may NEVER be broken.

Item No.	Page No.	Min Qty	Case Qty	List Price	UPC Bar-Coded	UPC 5-Digit 739236	Weight (lbs)
834-4HTQ	141	1	1	47.75		37459	1.7046
834-4HTR	141	1	1	35.25		37447	1.3946
834-4PBQ	141	1	1	113.00		37545	5.9673
834-4PBR	141	1	1	91.50		37461	5.1363
834-4PF	141	1	10	22.75		37389	1.7246
834-4PNQ	141	1	1	103.00		37546	5.9707
834-4PNR	141	1	1	74.00		36518	4.5742
834-4PTQ	141	1	1	71.50		37547	3.9942
834-4PTR	141	1	1	59.00		37417	3.6842
840-20A	162	20	20	6.50	✓	30072	0.4763
840-20ABR	162	1	10	36.25	✓	35243	1.1770
840-20ANR	162	1	10	26.50	✓	30073	0.8328
840-20P	162	20	20	6.50	✓	30060	0.5353
840-20PBR	162	1	10	36.25	✓	30075	1.2338
840-20PNR	162	1	10	26.50	✓	30076	0.8896
840-20PP	162	1	10	12.75	✓	35144	0.5293
840-27A	162	20	20	5.00	✓	35157	0.4658
840-27P	162	20	20	5.00	✓	30077	0.5440
840-2A	162	20	20	5.00	✓	30078	0.4747
840-2APK	162	10	10	5.13	✓	30054	0.4783
840-2P	162	20	20	5.00	✓	30079	0.5489
840-2PP	162	1	10	13.50	✓	35248	0.7763
840-2PPK	162	10	10	5.13	✓	30050	0.5573
840-30A	162	1	20	8.50	✓	35249	0.4975
840-30ABR	162	1	10	37.25	✓	35250	1.1812
840-30ANR	162	1	10	27.50	✓	35251	0.8518
840-30P	162	1	20	8.50	✓	35155	0.5992
840-30PBR	162	1	10	37.25	✓	30080	1.2752
840-30PNR	162	1	10	27.50	✓	30081	0.9458
840-37A	162	1	10	8.25	✓	35254	0.5118
840-37P	162	1	10	8.25	✓	30082	0.5996
840-3A	162	20	20	7.25	✓	30083	0.5837
840-3APK	162	10	10	7.38	✓	30074	0.5873
840-3P	162	20	20	7.25	✓	30084	0.5784
840-3PPK	162	10	10	7.38	✓	30070	0.6123
841-29P	161	12	12	16.25	✓	35137	1.6093
841-29PL	161	12	12	14.25	✓	30085	1.6261
841-2A	160	12	12	10.75	✓	30020	0.9521
841-2ANR	160	1	6	64.00	✓	35259	3.1448
841-2P	160	12	12	10.75	✓	30018	1.2415
841-2PNR	160	1	6	64.00	✓	35138	3.4524
841-39P	161	12	12	16.25	✓	35139	1.5569
841-39PL	161	12	12	14.25	✓	30091	1.5132
841-3P	160	1	12	17.00	✓	30019	1.6149
841-3PNR	160	1	12	50.75	✓	35260	2.6297
842-22i	180	2	2	9.00	✓	35261	1.6234
842-23i	180	2	2	11.50	✓	35140	2.9234
842-24i	180	2	2	16.25	✓	35173	4.7500
842-2ABQ	114	1	10	58.50	✓	35262	1.7485
842-2ABR	113	1	10	41.75	✓	35263	1.2985
842-2Ai	115	1	2	33.50	✓	35264	3.3066
842-2ANQ	114	1	10	49.50	✓	35265	1.8769
842-2ANR	113	1	10	33.50	✓	30093	1.3384
842-2AP	116	1	10	12.50	✓	35266	0.7384
842-2iLi	117	1	2	54.00	✓	35267	5.3354
842-2iLNQ	117	1	1	66.50	✓	35268	3.8075
842-2iLNR	117	1	2	56.00	✓	35141	3.4421
842-2LBQ	114	1	1	55.00	✓	30103	1.6278
842-2LBR	113	1	10	38.25	✓	30095	1.1778
842-2Li	115	1	5	30.00	✓	35269	3.1014
842-2LNQ	114	1	5	46.00	✓	30096	1.7007
842-2LNR	113	1	10	30.00	✓	30097	1.2076
842-2LP	116	1	10	9.00	✓	30098	0.5936
842-2PBQ	114	1	10	58.50	✓	30099	1.8725
842-2PBR	113	1	10	41.75	✓	30100	1.4225
842-2Pi	115	1	2	33.50	✓	30101	3.4306

Item No.	Page No.	Min Qty	Case Qty	List Price	UPC Bar-Coded	UPC 5-Digit 739236	Weight (lbs)	Item No.	Page No.	Min Qty	Case Qty	List Price	UPC Bar-Coded	UPC 5-Digit 739236	Weight (lbs)
842-2PNQ	114	1	10	49.50	✓	30102	1.9411	842-72A	178	5	5	2.50	✓	35298	0.1654
842-2PNR	113	1	10	33.50	✓	35642	1.4671	842-72P	178	5	5	2.50	✓	35299	0.2894
842-2PNRPK	113	6	6	34.77	✓	32022	1.5023	842-73A	178	5	5	5.50	✓	35300	0.4705
842-2PP	116	1	10	12.50	✓	33919	0.8624	842-73P	178	5	5	5.50	✓	30131	0.5625
842-36ABQ	114	1	1	83.10	✓	35270	3.4504	842-74A	178	10	10	7.75	✓	35301	1.1730
842-36ABR	113	1	10	66.50	✓	35271	2.5894	842-74P	178	10	10	7.75	✓	33923	0.8930
842-36Ai	115	1	2	50.00	✓	35272	5.8595	842-76A	178	1	10	21.50	✓	30133	1.5470
842-36ANQ	114	1	1	71.60	✓	35273	3.6080	842-76P	178	1	10	21.50	✓	35302	2.2810
842-36ANR	113	1	10	53.00	✓	35163	2.6080	842-82AT	179	1	10	8.25	✓	32628	0.3591
842-36AP	116	1	10	20.25	✓	35274	1.6013	842-82PT	179	1	10	8.25	✓	32626	0.4551
842-36LBQ	114	1	1	75.85	✓	35275	2.9807	842-83AT	179	1	10	10.25	✓	35171	0.7464
842-36LBR	113	1	10	59.25	✓	35276	2.1497	842-83PT	179	1	10	10.25	✓	32636	1.0394
842-36Li	115	1	5	42.75	✓	35277	5.3281	842-84AT	179	1	10	11.75	✓	35303	1.0160
842-36LNQ	114	1	5	64.35	✓	35143	3.1881	842-84PT	179	1	10	11.75	✓	32646	1.3204
842-36LNR	113	1	10	45.75	✓	30667	2.1383	842-92A	179	10	20	2.75	✓	32624	0.0308
842-36LP	116	1	10	13.00	✓	35278	1.1576	842-92P	179	10	20	2.75	✓	32622	0.0404
842-36PBQ	114	1	1	83.10	✓	35279	3.5424	842-93A	179	10	20	3.25	✓	32634	0.0749
842-36PBR	113	1	10	66.50	✓	35280	2.6814	842-93P	179	10	20	3.25	✓	32632	0.0937
842-36Pi	115	1	2	50.00	✓	35281	5.9515	842-94A	179	10	20	3.50	✓	32644	0.0998
842-36PNQ	114	1	1	71.60	✓	35136	3.7000	842-94P	179	10	20	3.50	✓	32642	0.1194
842-36PNR	113	1	10	53.00	✓	30668	2.7000	842-SB2	181	1	1	20.75	✓	30144	0.5542
842-36PP	116	1	10	20.25	✓	35282	1.7193	842-SB3	181	1	1	27.50	✓	35304	0.7242
842-3ABQ	114	1	10	74.25	✓	35283	2.7268	842-SB4	181	1	1	33.25	✓	35186	0.9985
842-3ABR	113	1	8	55.25	✓	35284	2.0538	842-Si2	181	1	1	12.00	✓	35305	1.6094
842-3Ai	115	1	2	44.50	✓	35285	4.9035	842-Si3	181	1	1	15.00	✓	35306	2.2500
842-3ANQ	114	1	10	61.50	✓	35286	2.9110	842-Si4	181	1	1	18.00	✓	35184	3.1134
842-3ANR	113	1	8	43.00	✓	35203	2.1424	842-SN2	181	1	1	17.75	✓	35307	0.2575
842-3AP	116	1	8	18.50	✓	35287	1.3394	842-SN3	181	1	1	21.00	✓	30145	1.1021
842-3iLi	117	1	2	61.75	✓	35288	7.5706	842-SN4	181	1	1	24.75	✓	30146	0.9766
842-3iLNQ	117	1	1	78.25	✓	35145	5.6904	842-SP2	181	1	1	5.00	✓	35308	0.2725
842-3iLNR	117	1	2	66.00	✓	35146	4.9854	842-SP3	181	1	1	6.00	✓	35309	0.4071
842-3LBQ	114	1	1	68.25	✓	35289	2.3148	842-SP4	181	1	1	8.00	✓	35310	0.5267
842-3LBR	113	1	10	49.25	✓	30573	1.6465	842-SS2	181	1	1	5.00	✓	35311	0.2610
842-3Li	115	1	5	38.50	✓	30110	4.3410	842-SS3	181	1	1	6.00	✓	35312	0.2930
842-3LNQ	114	1	5	55.50	✓	30574	2.4702	842-SS4	181	1	1	8.00	✓	35188	0.2942
842-3LNR	113	1	10	37.00	✓	30112	1.7444	843-2ABQ	118	1	1	58.50	✓	35313	1.7028
842-3LNRPK	113	5	5	38.27	✓	32031	1.8420	843-2ABR	118	1	10	40.00	✓	35314	1.2478
842-3LP	116	1	10	12.50	✓	30113	0.9321	843-2Ai	119	1	2	31.75	✓	35315	3.2656
842-3PBQ	114	1	10	74.25	✓	35147	2.8328	843-2ANQ	118	1	1	49.50	✓	35316	1.8452
842-3PBR	113	1	8	55.25	✓	30114	2.1798	843-2ANR	118	1	10	33.25	✓	30609	1.2974
842-3Pi	115	1	2	44.50	✓	33921	4.9093	843-2AP	119	1	10	10.75	✓	35317	0.6557
842-3PNQ	114	1	10	61.50	✓	30575	2.9534	843-2AS	119	1	10	10.75	✓	35318	0.6126
842-3PNR	113	1	8	43.00	✓	35643	2.2684	843-2PBQ	118	1	1	58.50	✓	30148	1.7928
842-3PNRPK	113	5	5	44.27	✓	32032	2.2886	843-2PBR	118	1	10	40.00	✓	35319	1.3378
842-3PP	116	1	8	18.50	✓	30576	1.4654	843-2Pi	119	1	2	31.75	✓	35320	3.3649
842-4ABQ	114	1	1	84.10	✓	35290	4.0824	843-2PNQ	118	1	1	49.25	✓	30149	1.8657
842-4ABR	113	1	10	67.50	✓	35291	3.2514	843-2PNR	118	1	10	33.25	✓	30581	1.3726
842-4Ai	115	1	2	51.00	✓	35292	6.4915	843-2PP	119	1	10	10.75	✓	30151	0.7757
842-4ANQ	114	1	1	72.60	✓	35293	4.2400	843-2PS	119	1	10	10.75	✓	30582	0.6928
842-4ANR	113	1	10	54.00	✓	35148	3.2400	843-3ABQ	118	1	1	67.75	✓	35321	2.2114
842-4AP	116	1	10	21.25	✓	35294	2.2650	843-3ABR	118	1	10	48.75	✓	35322	1.6075
842-4iLi	117	1	2	72.50	✓	35295	9.2200	843-3Ai	119	1	2	38.00	✓	35323	4.3449
842-4iLNQ	117	1	1	94.10	✓	35296	7.0800	843-3ANQ	118	1	1	55.00	✓	35324	2.4011
842-4iLNR	117	1	2	78.25	✓	30120	5.9806	843-3ANR	118	1	10	39.00	✓	35325	1.7054
842-4LBQ	114	1	1	76.85	✓	35297	2.8755	843-3AP	119	1	10	12.00	✓	35187	0.8604
842-4LBR	113	1	10	60.25	✓	30121	2.0717	843-3AS	119	1	10	12.00	✓	35326	0.7310
842-4Li	115	1	5	43.75	✓	30137	5.2190	843-3PBQ	118	1	1	67.75	✓	35327	2.3364
842-4LNQ	114	1	5	65.35	✓	30577	3.0790	843-3PBR	118	1	10	48.75	✓	35328	1.7325
842-4LNR	113	1	10	46.75	✓	30578	2.0603	843-3Pi	119	1	2	38.00	✓	30153	4.4606
842-4LP	116	1	10	14.00	✓	30125	1.0946	843-3PNQ	118	1	1	55.00	✓	35195	2.5261
842-4PBQ	114	1	10	84.10	✓	35149	3.8024	843-3PNR	118	1	10	39.00	✓	30583	1.8304
842-4PBR	113	1	10	67.50	✓	30126	2.9714	843-3PP	119	1	10	12.00	✓	30584	0.9914
842-4Pi	115	1	2	51.00	✓	30579	6.2115	843-3PS	119	1	10	12.00	✓	30680	0.8560
842-4PNQ	114	1	1	72.60	✓	30128	3.9600	843-4ABQ	118	1	1	76.10	✓	35329	2.7584
842-4PNR	113	1	10	54.00	✓	32042	2.9600	843-4ABR	118	1	4	59.50	✓	35330	2.0280
842-4PP	116	1	10	21.25	✓	35142	1.9850	843-4Ai	119	1	2	43.00	✓	35331	5.3050

A 10% surcharge will be applied to any item NOT purchased in multiples of the stated Minimum Quantity, except on drop ship orders. Items that are bold in the Min Qty column may NEVER be broken.

Numerical Index

CATALOG 2007

NUMERICAL INDEX

NUMERICAL INDEX

NUMERICAL INDEX

NUMERICAL INDEX

NUMERICAL INDEX

Item No.	Page No.	Min Qty	Case Qty	List Price	UPC Bar-Coded	UPC 5-Digit 739236	Weight (lbs)	Item No.	Page No.	Min Qty	Case Qty	List Price	UPC Bar-Coded	UPC 5-Digit 739236	Weight (lbs)
843-4ANQ	118	1	1	64.60	✓	35332	3.0459	850-3iN	149	1	4	176.00	✓	35342	10.4467
843-4ANR	118	1	4	49.50	✓	35333	2.0177	850-3N	149	1	6	156.75	✓	30190	7.3549
843-4AP	119	1	4	13.25	✓	35334	1.0770	850-3T	149	1	6	64.75	✓	30191	2.6969
843-4AS	119	1	4	13.25	✓	35335	0.7497	850-4i	149	1	2	65.00	✓	30585	12.7947
843-4PBQ	118	1	1	76.10	✓	35189	2.9550	850-4iN	149	1	2	221.00	✓	35344	16.6057
843-4PBR	118	1	4	59.50	✓	35182	2.1240	850-4N	149	1	6	205.00	✓	30607	9.8086
843-4Pi	119	1	2	43.00	✓	30167	5.4000	850-4T	149	1	1	98.50	✓	30586	3.4826
843-4PNQ	118	1	1	64.60	✓	35190	3.1124	850-Ci2	185	1	1	17.25	✓	35346	2.2082
843-4PNR	118	1	4	49.50	✓	30158	2.1127	850-Ci3	185	1	1	21.00	✓	35347	3.5283
843-4PP	119	1	4	13.25	✓	30159	1.1970	850-Ci4	185	1	1	25.00	✓	35348	5.1484
843-4PS	119	1	4	13.25	✓	30678	0.8897	850-CN2	185	1	1	47.50	✓	35349	1.7564
844-02G	183	1	10	5.00	✓	30161	1.2747	850-CN3	185	1	1	60.00	✓	35197	2.0144
844-02SL	165	2	2	10.00	✓	34421	2.6805	850-CN4	185	1	1	93.25	✓	35350	3.6878
844-04G	183	1	10	15.00	✓	30163	3.8496	850-CT2	185	1	1	21.00	✓	35351	0.6485
844-04iQ	165	2	2	21.00	✓	34412	9.2075	850-CT3	185	1	1	36.80	✓	30195	0.7085
844-04SL	165	2	2	23.00	✓	34423	10.1585	850-CT4	185	1	1	58.10	✓	35352	1.2587
844-0G	183	1	10	7.00	✓	30165	1.4396	850-VW1	186	10	10	15.00	✓	35192	0.0351
844-0SL	165	2	2	12.50	✓	34422	5.1130	850-VW4	186	10	10	15.00	✓	35353	0.0451
844-22i	120	1	4	47.50	✓	35336	5.3360	850-VW8	186	10	10	15.00	✓	35354	0.0281
844-22NQ	120	1	1	64.25	✓	35337	3.7658	851-24i	147	1	2	65.00	✓	30587	8.6735
844-22NR	120	1	4	43.75	✓	30168	3.2825	851-24iN	147	1	2	146.00	✓	35360	10.6060
844-23i	120	1	4	50.50	✓	35191	7.8658	851-24N	147	1	2	107.00	✓	35194	5.3834
844-23NQ	120	1	1	71.25	✓	35338	5.8108	851-24T	147	1	2	83.00	✓	35362	3.0234
844-23NR	120	1	4	49.25	✓	30169	5.1447	851-26i	147	1	2	115.00	✓	35185	14.7364
844-24i	120	1	4	54.50	✓	35198	9.5158	851-26iN	147	1	2	228.75	✓	35363	15.2483
844-24NQ	120	1	1	80.35	✓	35339	7.3609	851-26N	147	1	2	192.75	✓	35365	8.6452
844-24NR	120	1	4	65.50	✓	35193	6.2381	851-26T	147	1	2	148.50	✓	35366	6.7811
844-S4	183	1	1	6.50	✓	30170	1.2397	851-33N	146	1	2	82.00	✓	35370	3.0961
845-2APK	161	10	10	1.88	✓	30132	0.0662	851-33T	146	1	2	58.50	✓	35371	1.0561
845-2P	161	20	20	1.75	✓	30177	0.0758	851-34i	146	1	2	55.00	✓	30588	8.3135
845-2PPK	161	10	10	1.88	✓	30130	0.0828	851-34iN	146	1	2	136.00	✓	35372	10.1687
845-330P	161	20	20	2.75	✓	30172	0.1626	851-34N	146	1	2	92.00	✓	30589	5.0168
845-330PS	161	20	20	5.50	✓	30183	0.3399	851-34T	146	1	2	68.00	✓	30672	2.6568
845-3APK	161	10	10	2.88	✓	30136	0.1709	851-36i	146	1	2	109.00	✓	35374	14.4978
845-3P	161	20	20	2.75	✓	30185	0.1784	851-36iN	146	1	2	222.75	✓	35375	18.3759
845-3PPK	161	10	10	2.88	✓	30134	0.2084	851-36N	146	1	2	168.00	✓	35377	8.2747
845-3PS	161	20	20	5.75	✓	30135	0.3462	851-36T	146	1	2	110.00	✓	35378	4.6474
845-4APK	161	10	10	3.88	✓	30140	0.2600	851-43N	146	1	2	82.00	✓	30590	3.1681
845-4P	161	20	20	3.75	✓	33924	0.3105	851-43T	146	1	2	58.50	✓	30201	1.1281
845-4PPK	161	10	10	3.88	✓	30138	0.3443	851-44i	146	1	2	55.00	✓	30591	8.2555
845-4PS	161	20	20	8.00	✓	30139	0.5063	851-44iN	146	1	2	136.00	✓	35168	10.1574
846-S11PK	184	6	6	7.00	✓	30642	1.7680	851-44N	146	1	2	92.00	✓	30203	4.9588
846-S13PK	184	6	6	7.50	✓	30644	2.3300	851-44T	146	1	2	68.00	✓	35651	2.5988
846-S15PK	184	6	6	8.00	✓	30646	1.8500	851-46i	146	1	2	109.00	✓	30205	15.7781
846-S17PK	184	6	6	10.00	✓	30656	2.2500	851-46iN	146	1	2	222.75	✓	35169	19.7099
846-S19PK	184	6	6	14.00	✓	30666	2.9670	851-46N	146	1	2	168.00	✓	30206	9.6087
846-S1PK	184	6	6	3.25	✓	30630	1.2097	851-46T	146	1	2	110.00	✓	30674	5.6287
846-S3PK	184	6	6	3.75	✓	30632	0.9357	851-64i	148	1	2	80.00	✓	35170	11.3494
846-S5PK	184	6	6	5.50	✓	30636	1.2710	851-64N	148	1	2	122.00	✓	35174	8.0901
846-S7PK	184	6	6	6.00	✓	30638	1.5170	851-64T	148	1	2	98.00	✓	35390	5.7301
846-S9PK	184	6	6	6.50	✓	30640	1.6000	851-66i	148	1	2	197.00	✓	35181	24.1451
847-2	163	20	20	4.25	✓	33925	0.1550	851-66N	148	1	2	277.75	✓	35393	17.9757
847-2PK1	163	10	10	5.43	✓	30122	0.1864	851-66T	148	1	2	230.50	✓	35394	13.8785
847-3	163	20	20	4.50	✓	30669	0.3200	851-Ci3	185	1	1	16.00	✓	35395	1.5223
847-3PK1	163	10	10	5.68	✓	30123	0.3533	851-Ci4	185	1	1	17.50	✓	35396	2.1766
847-4	163	10	10	5.00	✓	30181	0.4464	851-Ci6	185	1	1	23.00	✓	35397	3.5811
847-4PK1	163	10	10	6.18	✓	30124	0.5260	851-Ci8	185	1	1	25.00	✓	35398	5.1366
847-7	163	10	10	22.00	✓	30127	1.1143	851-CN3	185	1	1	48.00	✓	35183	1.1423
847-7B	163	20	20	17.25	✓	30611	0.9393	851-CN4	185	1	1	58.00	✓	35165	1.1066
847-9	163	1	10	50.00	✓	30129	2.0400	851-CN6	185	1	1	78.00	✓	35399	3.0811
850-234N	149	1	10	60.50	✓	35196	4.2480	851-CN8	185	1	1	97.75	✓	35400	3.9011
850-2i	149	1	6	45.00	✓	30147	7.0343	851-CT3	185	1	1	25.75	✓	30211	0.4270
850-2iN	149	1	6	159.50	✓	35340	8.8834	851-CT4	185	1	1	34.50	✓	35401	0.6522
850-2N	149	1	6	114.75	✓	30187	4.4304	851-CT6	185	1	10	42.25	✓	35176	1.1811
850-2T	149	1	6	51.25	✓	30188	1.6904	851-CT8	185	1	1	55.25	✓	35402	1.3111
850-3i	149	1	4	50.00	✓	30189	9.8063	852-2ABR	142	1	5	44.75	✓	35404	1.6820

A 10% surcharge will be applied to any item NOT purchased in multiples of the stated Minimum Quantity, except on drop ship orders. Items that are bold in the Min Qty column may NEVER be broken.

Item No.	Page No.	Min Qty	Case Qty	List Price	UPC Bar-Coded	UPC 5-Digit 739236	Weight (lbs)	Item No.	Page No.	Min Qty	Case Qty	List Price	UPC Bar-Coded	UPC 5-Digit 739236	Weight (lbs)
852-2ANR	142	1	5	42.75	✓	35407	1.7199	858-62L	179	1	4	35.75	✓	35464	3.2662
852-2LBR	142	1	10	41.25	✓	30213	1.5312	858-63L	179	1	4	36.50	✓	35092	4.3340
852-2LNR	142	1	10	39.25	✓	30216	1.5691	858-64L	179	1	4	37.25	✓	30236	4.3038
852-2PBR	142	1	5	44.75	✓	35177	1.8060	860-2A	124	1	4	55.00	✓	35465	4.2296
852-2PNR	142	1	5	42.75	✓	30215	1.8439	860-2Ai	124	1	2	95.00	✓	35466	15.3775
852-3ABQ	143	1	5	86.25	✓	35426	3.4711	860-2AN	124	1	4	246.00	✓	35467	9.1450
852-3ABR	142	1	5	61.25	✓	35427	2.7981	860-2AX	124	1	4	35.00	✓	35468	3.0150
852-3Ai	144	1	2	40.75	✓	35428	4.6802	860-2P	124	1	4	55.00	✓	35081	5.5076
852-3ANQ	143	1	2	81.75	✓	35429	3.5923	860-2Pi	124	1	2	95.00	✓	35469	16.1025
852-3ANR	142	1	5	53.50	✓	35034	2.8160	860-2PN	124	1	4	246.00	✓	30238	9.9700
852-3AP	144	1	1	20.25	✓	35430	1.4490	860-2PX	124	1	4	35.00	✓	35084	3.7500
852-3ATR	142	1	5	38.25	✓	35432	1.7060	860-3A	124	1	4	55.00	✓	35085	3.9296
852-3LBQ	143	1	1	80.25	✓	35436	3.0352	860-3Ai	124	1	2	95.00	✓	35086	15.0775
852-3LBR	142	1	10	55.25	✓	30217	2.3622	860-3AN	124	1	4	246.00	✓	35470	8.3150
852-3Li	144	1	2	34.75	✓	35178	4.2123	860-3AX	124	1	4	35.00	✓	35471	2.6250
852-3LNQ	143	1	1	75.75	✓	35179	3.1496	860-3P	124	1	4	55.00	✓	33703	5.1076
852-3LNR	142	1	10	47.50	✓	30218	2.3801	860-3Pi	124	1	2	95.00	✓	30562	15.7025
852-3LP	144	1	10	14.25	✓	35437	1.0551	860-3PN	124	1	4	246.00	✓	30511	9.0400
852-3LTR	142	1	10	32.25	✓	30219	1.2701	860-3PSPK	124	2	2	65.36	✓	33708	6.3226
852-3PBQ	143	1	5	86.25	✓	35180	3.5631	860-3PX	124	1	4	35.00	✓	35225	3.3500
852-3PBR	142	1	5	61.25	✓	30220	2.8901	860-4A	124	1	4	55.00	✓	35472	3.9246
852-3Pi	144	1	2	40.75	✓	35069	4.7722	860-4Ai	124	1	2	95.00	✓	35473	14.9025
852-3PNQ	143	1	2	81.75	✓	35072	3.6843	860-4AN	124	1	4	246.00	✓	35474	8.8400
852-3PNR	142	1	5	53.50	✓	35032	2.9080	860-4AX	124	1	4	35.00	✓	35475	2.6200
852-3PP	144	1	1	20.25	✓	35073	1.5544	860-4P	124	1	4	55.00	✓	35226	5.0626
852-3PTR	142	1	5	38.25	✓	30605	1.7980	860-4Pi	124	1	2	95.00	✓	35227	15.7025
852-4ABQ	143	1	5	101.25	✓	35440	5.3875	860-4PN	124	1	4	246.00	✓	30675	9.5250
852-4ABR	142	1	10	80.50	✓	35441	4.2303	860-4PX	124	1	4	35.00	✓	35080	3.3050
852-4Ai	144	1	2	53.00	✓	35074	7.1494	860-4SS	126	1	1	1,495.00	✓	37572	24.7700
852-4ANQ	143	1	2	91.25	✓	35442	5.1565	860-6	126	1	10	6.00	✓	35476	0.2697
852-4ANR	142	1	10	60.00	✓	35044	3.6683	860-6A	124	1	1	130.00	✓	35477	5.9146
852-4AP	144	1	1	27.50	✓	35443	2.4668	860-6Ai	124	1	1	170.00	✓	35478	15.3825
852-4ATR	142	1	10	49.00	✓	35445	2.7783	860-6AN	124	1	1	321.00	✓	35479	10.3000
852-4iLi	145	1	1	73.75	✓	35075	9.8211	860-6AX	124	1	1	110.00	✓	35480	4.6100
852-4iLNQ	145	1	1	112.00	✓	35446	7.7504	860-6P	124	1	1	130.00	✓	35051	8.4850
852-4iLNR	145	1	2	91.25	✓	30594	6.3758	860-6Pi	124	1	1	170.00	✓	35052	18.6875
852-4LBQ	143	1	1	78.25	✓	35447	3.9339	860-6PN	124	1	1	321.00	✓	35481	12.3800
852-4LBR	142	1	10	75.75	✓	30595	3.0507	860-6PX	124	1	1	110.00	✓	35482	6.6900
852-4Li	144	1	2	45.75	✓	30596	6.0027	860-C	126	1	1	10.00	✓	35053	0.7882
852-4LNQ	143	1	1	84.00	✓	30227	4.0098	860-D	126	1	1	6.00	✓	30569	0.2820
852-4LNR	142	1	10	55.25	✓	30228	2.4886	860-GA	126	1	1	20.00	✓	35054	1.3883
852-4LNRPK	142	5	5	56.52	✓	35041	2.5329	860-GA2	126	1	1	15.00	✓	35483	0.6435
852-4LP	144	1	10	20.25	✓	35076	1.3668	860-GA3	126	1	1	18.00	✓	35484	0.9929
852-4LTR	142	1	10	41.75	✓	30597	1.5986	860-Gi	126	1	1	50.00	✓	35055	9.4100
852-4PBQ	143	1	5	101.25	✓	35077	4.7813	860-GN	126	1	1	146.00	✓	30550	2.6800
852-4PBR	142	1	10	80.50	✓	30598	3.9503	860-GN2	126	1	1	101.25	✓	30255	3.8800
852-4Pi	144	1	2	53.00	✓	30599	6.9089	860-GN3	126	1	1	121.00	✓	30549	4.6800
852-4PNQ	143	1	2	91.25	✓	30603	4.8765	860-GP	126	1	1	20.00	✓	30257	1.8451
852-4PNR	142	1	10	60.00	✓	35042	3.3883	860-GP2	126	1	1	15.00	✓	30499	1.2830
852-4PP	144	1	1	27.50	✓	30240	2.2898	860-GP3	126	1	1	18.00	✓	35056	2.2604
852-4PTR	142	1	10	49.00	✓	30235	2.4983	860-GPJ	126	1	1	25.00	✓	30548	2.1476
852-CB2	184	1	1	33.50	✓	35450	0.9629	860-RGN	126	1	1	211.00	✓	35057	5.6900
852-CB3	184	1	1	41.50	✓	35451	1.4572	860-RGN2	126	1	1	180.00	✓	35058	5.1300
852-CB4	184	1	1	51.50	✓	35452	1.9372	860-RGN3	126	1	1	195.50	✓	35485	5.1000
852-Ci2	184	1	1	15.50	✓	35453	1.6457	860-S	126	1	1	9.00	✓	30278	1.0330
852-Ci3	184	1	1	17.00	✓	35454	2.3000	860-U	126	1	1	8.00	✓	30261	0.8580
852-Ci4	184	1	1	25.00	✓	35455	3.6500	860-UM	126	1	1	72.00	✓	30483	0.7382
852-CN2	184	1	1	30.65	✓	35456	0.9809	861-22X	121	1	1	92.00	✓	30275	22.0000
852-CN3	184	1	1	35.25	✓	35457	1.4809	861-23X	121	1	1	92.00	✓	30274	25.3600
852-CN4	184	1	1	43.00	✓	35079	1.8551	861-24X	121	1	1	92.00	✓	30265	23.2000
852-CP2	184	1	1	6.50	✓	35458	0.4609	861-2P	122	1	1	81.00	✓	35070	7.0593
852-CP3	184	1	1	8.50	✓	35459	0.5809	861-2Pi	122	1	1	175.00	✓	35486	16.3867
852-CP4	184	1	1	11.00	✓	35460	0.8051	861-2PN	122	1	1	387.00	✓	35487	15.5067
852-CT2	184	1	1	18.50	✓	35461	0.5109	861-2PX	122	1	3	65.00	✓	30552	5.3067
852-CT3	184	1	1	20.50	✓	35462	0.6809	861-3P	122	1	1	81.00	✓	30267	7.8350
852-CT4	184	1	1	23.50	✓	35463	0.8651	861-3Pi	122	1	1	175.00	✓	35488	15.6000

A 10% surcharge will be applied to any item NOT purchased in multiples of the stated Minimum Quantity, except on drop ship orders. Items that are bold in the Min Qty column may NEVER be broken.

Numerical Index

NUMERICAL INDEX

Item No.	Page No.	Min Qty	Case Qty	List Price	UPC Bar-Coded	UPC 5-Digit 739236	Weight (lbs)
861-3PN	122	1	1	387.00	✓	30273	15.6000
861-3PX	122	1	3	65.00	✓	30553	5.3467
861-4P	122	1	1	83.50	✓	35050	8.9043
861-4Pi	122	1	1	177.50	✓	35489	15.5917
861-4PN	122	1	1	389.50	✓	35490	15.5917
861-4PX	122	1	3	67.50	✓	30554	5.3917
861-5	123	1	1	26.00		30555	1.8460
861-51	123	1	1	16.00		30560	1.1873
861-51N	123	1	1	142.50		30276	4.2729
861-51NR	123	1	1	260.50		35062	11.0861
861-52i	121	1	1	19.50		30277	4.0500
861-53	123	1	1	19.50		30561	1.5823
861-53i	121	1	1	19.50		30279	4.8080
861-53N	123	1	1	173.50		30280	6.0800
861-53NR	123	1	1	292.75		35491	9.4000
861-5Ci	123	1	1	120.00		35063	10.5211
861-5CiG	123	1	1	70.00		30482	7.6400
861-5i	121	1	1	19.50		30282	5.6960
861-5N	123	1	1	210.00		30285	6.6400
861-5NR	123	1	1	332.00		30284	10.5211
861-6	123	1	1	8.00		30556	0.2666
861-6P	122	1	1	136.00	✓	35492	8.2288
861-6Pi	122	1	1	230.00	✓	35493	16.0895
861-6PN	122	1	1	442.00	✓	35494	16.0895
861-6PX	122	1	3	120.00	✓	30286	4.7615
861-AD	121	1	1	13.25		30287	0.4510
861-D	123	1	1	8.00		30288	0.2820
861-UM	123	1	1	85.00		30289	1.2422
863-22i	133	1	2	86.25	✓	35497	13.3858
863-22NQ	133	1	2	107.85	✓	35498	11.2458
863-22NR	133	1	3	92.75	✓	30290	10.1437
863-23i	133	1	2	86.25	✓	35501	11.5314
863-23NQ	133	1	2	107.85	✓	35502	9.3914
863-23NR	133	1	2	92.75	✓	35064	8.3914
863-24i	133	1	2	86.25	✓	35505	13.0314
863-24NQ	133	1	2	107.85	✓	35506	10.8914
863-24NR	133	1	2	92.75	✓	35507	9.8914
863-325BQ	132	1	2	90.75	✓	35508	4.3034
863-325BR	131	1	3	71.75	✓	35509	3.5282
863-325i	131	1	2	61.00	✓	35510	6.2883
863-325NQ	132	1	2	78.00	✓	35511	4.3377
863-325NR	131	1	6	59.50	✓	30291	3.6327
863-325P	132	1	3	35.00	✓	35512	2.8172
863-32BQ	132	1	2	99.85	✓	35513	4.9374
863-32BR	131	1	3	83.25	✓	35514	4.0956
863-32i	131	1	2	66.75	✓	35515	7.2443
863-32NQ	132	1	2	88.35	✓	35516	5.1043
863-32NR	131	1	6	69.75	✓	35517	4.0087
863-32P	132	1	3	37.00	✓	35518	3.1035
863-335BQ	132	1	2	90.75	✓	35519	4.5863
863-335BR	131	1	2	71.75	✓	35520	3.7954
863-335i	131	1	2	61.00	✓	35521	4.5000
863-335NQ	132	1	2	78.00	✓	35522	4.5983
863-335NR	131	1	6	59.50	✓	35065	3.7977
863-335P	132	1	2	35.00	✓	35523	3.0843
863-33BQ	132	1	2	99.85	✓	35524	3.1400
863-33BR	131	1	2	83.25	✓	35525	4.1484
863-33i	131	1	2	66.75	✓	35526	7.2863
863-33NQ	132	1	2	88.35	✓	35527	5.1463
863-33NR	131	1	6	69.75	✓	35528	4.0507
863-33P	132	1	2	37.00	✓	35529	3.1713
863-345BQ	132	1	2	90.75	✓	35530	3.1400
863-345BR	131	1	2	71.75	✓	35531	4.0200
863-345i	131	1	2	61.00	✓	35532	6.5033
863-345NQ	132	1	2	78.00	✓	35533	4.6483
863-345NR	131	1	6	59.50	✓	35534	3.7583

A 10% surcharge will be applied to any item NOT purchased in multiples of the stated Minimum Quantity, except on drop ship orders. Items that are bold in the Min Qty column may NEVER be broken.

Item No.	Page No.	Min Qty	Case Qty	List Price	UPC Bar-Coded	UPC 5-Digit 739236	Weight (lbs)
863-345P	132	1	2	35.00	✓	35535	4.0000
863-34BQ	132	1	2	99.85	✓	35536	3.1400
863-34BR	131	1	2	83.25	✓	35537	4.1984
863-34i	131	1	2	66.75	✓	35538	7.3363
863-34NQ	132	1	2	88.35	✓	35539	5.1963
863-34NR	131	1	6	69.75	✓	35540	4.1007
863-34P	132	1	2	37.00	✓	35541	3.2213
863-425BQ	132	1	2	90.75	✓	35542	4.5884
863-425BR	131	1	3	71.75	✓	35067	3.8132
863-425i	131	1	2	61.00	✓	35543	6.5733
863-425NQ	132	1	2	78.00	✓	35068	4.7183
863-425NR	131	1	6	59.50	✓	30293	3.9177
863-425P	132	1	3	35.00	✓	35544	3.1022
863-42BQ	132	1	2	99.85	✓	35545	5.2224
863-42BR	131	1	3	83.25	✓	35059	4.3806
863-42i	131	1	2	66.75	✓	35546	7.5293
863-42NQ	132	1	2	88.35	✓	35115	5.4333
863-42NR	131	1	6	69.75	✓	30295	4.2937
863-42P	132	1	3	37.00	✓	35547	3.3885
863-435BQ	132	1	2	90.75	✓	35548	4.6534
863-435BR	131	1	2	71.75	✓	35549	3.9804
863-435i	131	1	2	61.00	✓	35550	6.6383
863-435NQ	132	1	2	78.00	✓	35116	4.7833
863-435NR	131	1	6	59.50	✓	30298	3.9827
863-435P	132	1	2	35.00	✓	35117	3.2693
863-43BQ	132	1	2	99.85	✓	35551	5.1494
863-43BR	131	1	2	83.25	✓	30300	4.3184
863-43i	131	1	2	66.75	✓	35552	7.4563
863-43NQ	132	1	2	88.35	✓	30481	5.3163
863-43NR	131	1	6	69.75	✓	30480	4.2207
863-43P	132	1	2	37.00	✓	35553	3.3413
863-445BQ	132	1	2	90.75	✓	35554	4.6434
863-445BR	131	1	2	71.75	✓	35555	3.9704
863-445i	131	1	2	61.00	✓	35556	6.6283
863-445NQ	132	1	2	78.00	✓	35557	4.7733
863-445NR	131	1	6	59.50	✓	30304	3.9727
863-445P	132	1	2	35.00	✓	35558	3.2593
863-44BQ	132	1	2	99.85	✓	35559	5.1544
863-44BR	131	1	2	83.25	✓	35560	4.3234
863-44i	131	1	2	66.75	✓	35120	7.4613
863-44NQ	132	1	2	88.35	✓	35561	5.3213
863-44NR	131	1	6	69.75	✓	30478	4.2257
863-44P	132	1	2	37.00	✓	35562	3.3463
863-62i	134	1	2	89.25	✓	35565	11.9244
863-62NQ	134	1	2	110.85	✓	35566	9.7844
863-62NR	134	1	3	95.75	✓	35567	8.7844
863-63i	134	1	2	89.25	✓	35570	13.3714
863-63NQ	134	1	2	110.85	✓	35571	11.2314
863-63NR	134	1	2	95.75	✓	35121	10.2314
863-64i	134	1	2	89.25	✓	35574	13.5844
863-64NQ	134	1	2	110.85	✓	35575	11.4444
863-64NR	134	1	2	95.75	✓	35576	10.4444
863-FA	126	1	5	30.00		35577	0.9100
863-FN	126	1	5	63.25		35112	2.4752
863-FNO	126	1	5	85.00		35134	6.0962
863-HA23	180	1	10	24.50	✓	30447	1.8834
863-HA33	180	1	10	24.50	✓	35578	2.0484
863-HA34	180	1	10	24.50	✓	35579	2.0034
863-HA43	180	1	10	24.50	✓	35580	2.0984
863-HA44	180	1	10	24.50	✓	35581	2.0534
863-HC223	180	1	1	24.50	✓	35582	10.6082
863-HC233	180	1	1	30.50	✓	35583	8.8572
863-HC234	180	1	1	40.00	✓	35584	8.7332
863-HC243	180	1	1	40.00	✓	35585	10.3572
863-HC244	180	1	1	40.00	✓	35586	10.2332
863-HP23	180	1	10	24.50	✓	30329	2.1684

Item No.	Page No.	Min Qty	Case Qty	List Price	UPC Bar-Coded	UPC 5-Digit 739236	Weight (lbs)
863-HP33	180	1	10	24.50	✓	30313	2.2334
863-HP34	180	1	10	24.50	✓	35153	2.1734
863-HP43	180	1	10	24.50	✓	35135	2.2234
863-HP44	180	1	10	24.50	✓	30315	2.1784
863-U	126	1	5	15.00		30557	0.3194
864-2A	121	1	3	35.50	✓	35124	4.2044
864-2P	121	1	3	35.50	✓	35114	3.0750
864-3A	121	1	3	35.50	✓	35587	4.3694
864-3P	121	1	3	35.50	✓	30317	3.1400
864-4A	121	1	3	35.50	✓	35588	4.3294
864-4P	121	1	3	35.50	✓	30321	3.1300
864-GP	121	1	1	13.50	✓	35589	1.2088
864-S	121	1	10	8.50	✓	30319	0.4246
866-2APK	164	5	5	8.20	✓	30107	0.5932
866-2i	164	2	2	26.00	✓	30105	5.1992
866-2P	164	1	25	7.00	✓	30320	0.7700
866-2PPK	164	5	5	8.20	✓	30106	0.8952
866-2S	183	1	20	6.25	✓	35636	0.2248
866-2SPK	183	5	5	7.45		30116	0.2751
866-34APK	164	5	5	18.20	✓	30111	1.8360
866-34P	164	1	20	17.00	✓	30117	1.9200
866-34PPK	164	5	5	18.20	✓	30109	2.1680
866-3i	164	2	2	35.00	✓	30108	11.3000
866-3P	164	1	20	17.00	✓	30323	1.8100
866-3S	183	1	20	9.00	✓	30119	0.6900
866-4P	164	1	20	17.00	✓	30325	2.1000
866-S2i	183	2	2	7.00	✓	30115	1.4500
866-S3i	183	2	2	12.00	✓	30118	2.9500
867-30	186	50	50	3.10		31531	0.2360
867-30PK	186	25	25	3.22	✓	31530	0.2641
867-35	186	25	25	3.10		31532	0.2476
867-35PK	186	25	25	3.22	✓	31535	0.2481
867-A2	135	1	2	33.50	✓	35128	2.8422
867-A2M	135	1	2	58.50	✓	35590	6.8490
867-A3	135	1	2	33.50	✓	30326	2.9422
867-A3M	135	1	2	58.50	✓	35591	6.9490
867-A4	135	1	2	33.50	✓	35129	2.9922
867-A4M	135	1	2	58.50	✓	35592	6.9990
867-C	135	1	25	26.00		33918	0.6504
867-HC	135	1	5	11.00		35593	0.6700
867-HD	183	1	5	10.00	✓	35130	0.5883
867-MC	135	1	5	20.00		35594	3.6992
867-MD	183	1	5	32.50	✓	35131	4.6261
867-P2	135	1	2	33.50	✓	30330	3.0352
867-P2M	135	1	2	58.50	✓	35595	7.1790
867-P3	135	1	2	33.50	✓	33903	3.2872
867-P3M	135	1	2	58.50	✓	30333	7.2940
867-P4	135	1	2	33.50	✓	33904	3.3572
867-P4M	135	1	2	58.50	✓	30524	7.3640
868-5A	172	10	10	14.50	✓	30335	0.4876
868-5P	172	10	10	14.50	✓	30350	0.5476
868-9A	172	10	10	13.75	✓	30337	0.5026
868-9P	172	10	10	13.75	✓	30514	0.5846
868-A3	136	1	2	80.00	✓	35596	4.7475
868-A3M	136	1	2	115.00	✓	35597	5.9451
868-A4	136	1	2	80.00	✓	35598	5.2475
868-A4M	136	1	2	115.00	✓	35599	6.4451
868-A6	136	1	2	80.00	✓	30339	5.4975
868-A6M	136	1	2	115.00	✓	35600	6.6951
868-C	136	1	5	45.00		30340	2.1250
868-C8	136	1	5	57.00		35133	4.2229
868-E	136	1	5	45.00		30341	3.5609
868-HD	183	1	5	16.00	✓	35104	0.6485
868-i3	137	1	2	100.00	✓	35125	11.0975
868-i3M	137	1	2	135.00	✓	35601	12.2951
868-i4	137	1	2	100.00	✓	35123	11.7475

Item No.	Page No.	Min Qty	Case Qty	List Price	UPC Bar-Coded	UPC 5-Digit 739236	Weight (lbs)
868-i4M	137	1	2	135.00	✓	35094	12.9451
868-i6	137	1	2	130.00	✓	35095	12.0475
868-i6M	137	1	2	165.00	✓	35602	13.7473
868-MC	136	1	10	40.00		35603	1.6004
868-MD	183	1	5	45.00	✓	35096	2.0520
868-P3	136	1	2	80.00	✓	30518	5.0475
868-P3M	136	1	2	115.00	✓	35097	6.2451
868-P4	136	1	2	80.00	✓	30343	5.2475
868-P4M	136	1	2	115.00	✓	35098	6.4451
868-P6	136	1	2	80.00	✓	30519	4.4575
868-P6M	136	1	2	115.00	✓	35099	5.8529
868-P8	136	1	2	100.00		30345	8.8000
868-S	136	1	10	40.00		30509	2.6760
869-23	173	1	1	45.00		30347	2.4929
869-2A	173	1	8	30.00	✓	30508	0.6340
869-2P	173	1	8	30.00	✓	30600	0.7000
869-30	173	1	10	3.75		30429	0.0010
869-31	173	1	10	7.00		30351	0.0600
869-33	173	1	25	6.00		30380	0.3800
869-34	173	1	2	30.00		30353	3.4670
869-36	173	1	10	11.25		30379	0.3100
869-3A	173	4	4	33.00	✓	30606	1.5000
869-3A1	173	1	6	8.50		30357	0.3350
869-3AS	173	1	1	50.00	✓	30608	4.7400
869-3P	173	4	4	33.00	✓	30358	1.9500
869-3P1	173	1	10	8.50		30359	0.3350
869-3PPK	173	2	2	34.13	✓	30602	2.2630
869-3PS	173	1	1	50.00	✓	30604	6.8250
869-40	173	1	10	5.00		30361	0.0010
869-41	173	1	10	9.00		30366	0.1500
869-43	173	1	20	9.50		30363	0.3000
869-44	173	1	1	41.75		30364	7.3400
869-46	173	1	10	14.00		30365	0.7675
869-4A	173	6	6	42.00	✓	30614	2.9000
869-4A1	173	1	10	12.50		30367	0.7600
869-4AS	173	1	1	66.50	✓	30616	6.4000
869-4P	173	6	6	42.00	✓	30371	3.7000
869-4P1	173	1	10	12.50		30370	0.7600
869-4PPK	173	2	2	43.13	✓	30610	4.3200
869-4PS	173	1	1	66.50	✓	30612	12.6500
869-60	173	1	10	12.50		30372	0.0010
869-61	173	1	10	22.50		30373	0.6300
869-63	173	1	15	35.00		30377	1.5650
869-6A	173	1	1	147.00	✓	30626	7.7000
869-6A1	173	1	2	33.00		30376	1.8900
869-6P	173	1	1	147.00	✓	30620	9.8000
869-6P1	173	1	2	33.00		30378	1.8900
869-SV4	183	1	1	12.50	✓	34404	2.0452
869-V34	164	4	4	13.75	✓	30207	0.1565
869-V4	165	1	1	21.50	✓	34402	9.2468
870-2	152	1	25	2.00		35100	0.0341
870-2CM	152	1	25	2.75		30381	0.0574
870-3	150	25	25	3.50	✓	30523	0.1394
870-3PK1	151	10	10	4.68	✓	31213	0.2007
870-4	150	25	25	4.00	✓	30670	0.2258
870-4PK1	151	10	10	5.18	✓	31214	0.2881
870-5	150	25	25	6.50	✓	30409	0.4345
870-6	150	25	25	6.75	✓	30385	0.5189
870-6PK1	151	10	10	7.93	✓	31216	0.6336
870-8	150	10	10	8.50	✓	30386	0.6369
870-810	150	5	5	15.25	✓	30387	1.2381
870-812	150	5	5	21.25	✓	30388	1.7680
870-93	150	1	10	3.75	✓	30389	0.1661
870-94	150	1	10	6.00	✓	30390	0.4111
870-95	150	1	10	8.00	✓	30391	0.6466
870-96	150	1	10	9.75	✓	30392	0.8747

A 10% surcharge will be applied to any item NOT purchased in multiples of the stated Minimum Quantity, except on drop ship orders. Items that are bold in the Min Qty column may NEVER be broken.

Numerical Index

CATALOG 2007

NUMERICAL INDEX

NUMERICAL INDEX

NUMERICAL INDEX

NUMERICAL INDEX

NUMERICAL INDEX

Item No.	Page No.	Min Qty	Case Qty	List Price	UPC Bar-Coded	UPC 5-Digit 739236	Weight (lbs)
870-98	150	1	10	12.75	✓	30393	1.0067
870-B	152	25	25	2.75		30394	0.0846
870-B3	151	1	10	8.00	✓	30395	0.3377
870-B4	151	1	10	8.50	✓	30396	0.4173
870-B5	151	1	10	12.00	✓	30397	0.6242
870-B6	151	1	10	13.50	✓	30398	0.7172
870-B6PK1	151	10	10	14.68	✓	35204	0.7295
870-B8	151	1	10	16.50	✓	30399	0.8669
871-16	150	25	25	11.25	✓	30400	0.1540
871-18	150	1	10	15.00	✓	30401	0.2800
871-4	150	25	25	2.40	✓	31304	0.0716
871-6	150	25	25	4.50	✓	31306	0.1392
871-8	150	1	10	7.20	✓	31308	0.2798
872-16	150	25	25	14.50	✓	30405	0.1760
872-18	150	1	10	20.75	✓	30403	0.3080
872-4	150	25	25	7.50	✓	35641	0.0960
872-6	150	25	25	10.75	✓	31336	0.1840
872-8	150	1	10	13.25	✓	31338	0.2880
873-240	151	1	10	11.70	✓	30671	0.4530
873-240P	151	1	10	9.75		36966	0.3285
873-350	151	1	10	17.35	✓	30411	1.0138
873-350P	151	1	10	13.25		36976	0.5981
873-460	151	1	10	22.50	✓	30428	1.2212
873-460P	151	1	10	16.00		36977	0.7561
874-1	152	25	1000	0.75		30442	0.0173
874-1C	152	25	1000	1.40		30427	0.0204
874-1W	152	25	100	2.20		30679	0.0221
874-2	152	25	1000	1.15		30426	0.0274
874-3C	152	25	500	1.25		30417	0.0208
874-3W	152	25	1000	2.75		30425	0.0206
874-4	152	25	500	2.00		30419	0.0457
874-4C	152	25	500	1.50		30420	0.0538
874-4W	152	25	100	2.85		30421	0.0554
874-6	152	25	1000	3.50		30422	0.0681
874-6C	152	25	100	2.25		30423	0.0706
874-6W	152	25	100	4.95		35101	0.0709
875-2A	152	20	20	4.50	✓	31404	0.0930
875-2P	152	20	20	4.50	✓	31402	0.1107
875-3A	152	20	20	5.75	✓	31408	0.1608
875-3P	152	20	20	5.75	✓	31406	0.1903
875-4A	152	20	20	7.00	✓	31412	0.2197
875-4P	152	20	20	7.00	✓	26591	0.2422
875-8230P	152	1	10	10.50	✓	30430	0.3192
875-8340P	152	1	10	13.50	✓	30431	0.6519
875-8450P	152	1	5	14.85	✓	30432	0.9435
876-10PK	177	10	10	2.50	✓	30250	0.1228
876-15	177	20	20	2.85		30433	0.1568
876-15PK	177	10	10	2.97	✓	30251	0.1638
876-20	177	20	20	3.85		30440	0.2708
876-20PK	177	10	10	3.97	✓	30252	0.2778
876-25	177	20	20	4.85		30435	0.3358
876-25PK	177	10	10	4.97	✓	30253	0.3428
876-30	177	20	20	7.80		30439	0.5148
876-30PK	177	10	10	7.92	✓	30254	0.5218
876-35	177	20	20	9.45		30437	0.6623
876-35PK	177	10	10	9.57	✓	30256	0.6678
876-40	177	20	20	10.85		30438	0.7053
876-40PK	177	10	10	10.97	✓	30258	0.7181
876-50	177	1	10	19.95		30259	1.0647
876-60	177	1	4	22.55		30260	2.3541
877-20	177	1	20	4.20		36514	0.1908
877-20PK	177	10	10	4.32	✓	30262	0.2086
877-25	177	1	20	5.05		30263	0.3458
877-30	177	1	20	7.85		30444	0.5258
877-30PK	177	10	10	7.97	✓	30264	0.5436
877-35	177	1	20	9.70		30445	0.6623

Item No.	Page No.	Min Qty	Case Qty	List Price	UPC Bar-Coded	UPC 5-Digit 739236	Weight (lbs)
877-35PK	177	10	10	9.82	✓	30266	0.6801
877-40	177	1	20	11.50		30862	0.6473
877-40PK	177	10	10	11.62	✓	30268	0.6725
877-60	177	1	20	23.65		30270	1.9867
877-915	177	1	20	16.20		35607	0.4038
877-920	177	1	20	16.88		35608	0.4108
877-925	177	1	20	25.00		35609	0.9343
877-930	177	1	20	21.00		35610	1.2549
877-935	177	1	20	33.00		35611	1.4249
877-940	177	1	10	40.00		35113	1.7197
877-950	177	1	10	55.00		35103	2.5703
877-960	177	1	4	75.00		35612	3.8517
878-015	176	25	25	1.00		30448	0.0414
878-015PK	176	25	25	1.13	✓	30710	0.0428
878-020	176	25	25	1.05		30449	0.0585
878-020PK	176	25	25	1.18	✓	30720	0.0599
878-025	176	25	25	1.30		35093	0.0689
878-025PK	176	25	25	1.43	✓	30730	0.0840
878-030	176	25	25	1.45		30450	0.0898
878-030PK	176	25	25	1.58	✓	30740	0.1010
878-035	176	25	25	1.85		30451	0.1391
878-035PK	176	25	25	1.98	✓	30750	0.1480
878-040	176	25	25	2.15		30452	0.1651
878-040PK	176	25	25	2.28	✓	30760	0.1703
878-15	176	25	25	1.65		30453	0.0471
878-15PK	176	25	25	1.78	✓	30711	0.0485
878-20	176	25	25	1.60		30454	0.0642
878-20PK	176	25	25	1.73	✓	30721	0.0656
878-25	176	25	25	2.15		30455	0.0746
878-25PK	176	25	25	2.28	✓	30731	0.0897
878-30	176	25	25	2.50		30456	0.0955
878-30PK	176	25	25	2.63	✓	30741	0.1067
878-35	176	25	25	3.00		30457	0.1396
878-35PK	176	25	25	3.13	✓	30751	0.1485
878-40	176	25	25	3.50		30458	0.1708
878-40PK	176	25	25	3.63	✓	30761	0.1760
878-50	176	25	25	9.50		30459	0.5782
878-60	176	8	8	10.50		30460	1.0242
878-740	178	1	1	15.00		35613	0.9201
878-760	178	1	1	22.50		30461	1.5617
878-780	178	1	1	35.75		30462	2.3391
878-915	178	10	20	11.50		35614	0.2108
878-920	178	10	20	10.75		35105	0.2123
878-925	178	10	20	11.50		35615	0.0123
878-930	178	10	20	10.50		30463	0.4201
878-935	178	10	20	12.75		35616	0.4600
878-940	178	10	20	14.25		30464	0.4600
878-950	178	10	20	15.25		35106	1.0247
878-960	178	10	10	21.50		30465	1.5406
878-980	178	10	10	36.00		35107	2.3430
879-015	176	25	25	1.00		30466	0.0330
879-015PK	176	25	25	1.13		30810	0.0344
879-020	176	25	25	1.05		30467	0.0490
879-020PK	176	25	25	1.18		30820	0.0504
879-025	176	25	25	1.30		35617	0.0576
879-025PK	176	25	25	1.43		30830	0.0727
879-030	176	25	25	1.45		30468	0.0753
879-030PK	176	25	25	1.58		30840	0.0865
879-035	176	25	25	1.85		35618	0.1094
879-035PK	176	25	25	1.98		30850	0.1183
879-040	176	25	25	2.15		30469	0.1195
879-040PK	176	25	25	2.28		30860	0.1247
879-15	176	25	25	1.65		30470	0.0444
879-15PK	176	25	25	1.78		30811	0.0458
879-20	176	25	25	1.60		30471	0.0636
879-20PK	176	25	25	1.73		30821	0.0650

A 10% surcharge will be applied to any item NOT purchased in multiples of the stated Minimum Quantity, except on drop ship orders. Items that are bold in the Min Qty column may NEVER be broken.

Item No.	Page No.	Min Qty	Case Qty	List Price	UPC Bar-Coded	UPC 5-Digit 739236	Weight (lbs)
879-25	176	25	25	2.15		35619	0.0746
879-25PK	176	25	25	2.28		30831	0.0897
879-30	176	25	25	2.50		30472	0.0955
879-30PK	176	25	25	2.63		30841	0.1067
879-35	176	25	25	3.00		30473	0.1370
879-35PK	176	25	25	3.13		30851	0.1459
879-40	176	25	25	3.50		30474	0.1485
879-40PK	176	25	25	3.63		30861	0.1537
879-50	176	25	25	9.50		30475	0.4533
879-60	176	8	8	10.50		30476	0.7777
880	186	25	25	5.75		30477	0.5412
880-012	230	100	500	0.67		30281	0.0461
880-034	230	50	250	1.03		30283	0.1117
880-1	230	25	25	2.65		30231	0.2081
880-2	230	25	25	3.00		30232	0.2322
880-3	230	25	25	4.10		30233	0.3716
880-4	230	25	25	5.00		35639	0.4772
880-81	229	25	200	0.30		30484	0.0187
880-81C	229	25	200	0.32		30485	0.0187
880-81PK	229	50	50	0.44	✓	30303	0.0277
880-82	229	25	200	0.35		30487	0.0258
880-82C	229	25	200	0.37		30488	0.0279
880-82PK	229	50	50	0.49	✓	30307	0.0347
880-83	229	10	50	0.47		30490	0.0504
880-83C	229	10	50	0.49		30491	0.0504
880-83PK	229	25	25	0.61	✓	30308	0.0684
880-84	229	10	50	0.65		30493	0.0690
880-84C	229	10	50	0.67		30494	0.0690
880-84PK	229	25	25	0.79	✓	30310	0.0870
881-01-10	227	1	1	109.00		56655	0.0000
881-01-2	227	5	5	19.00		56654	0.0000
881-01-3	227	5	5	24.00		56653	0.0000
881-01-4	227	5	5	32.00		56652	0.0000
881-01-6	227	2	2	46.00		56651	0.0000
881-01-8	227	2	2	58.00		56650	0.0000
881-02A	229	1	10	33.50		30496	1.1262
881-02FP	229	100	1000	0.58		30497	0.0015
881-02H	229	1	25	15.00		30498	0.4189
881-1	230	100	1000	0.21		30241	0.0122
881-10	229	25	200	0.30		30500	0.0171
881-10C	229	25	200	0.32		30501	0.0171
881-12	229	25	200	0.35		30502	0.0256
881-12C	229	25	200	0.37		30503	0.0256
881-13	229	10	50	0.47		30504	0.0464
881-13C	229	10	50	0.49		30505	0.0464
881-14	229	10	50	0.62		30506	0.0608
881-14C	229	10	50	0.64		30507	0.0637
881-2	230	100	1000	0.25		30242	0.0158
881-23CH	232	1	10	31.60		37386	0.5666
881-3	230	50	500	0.37		35640	0.0332
881-4	230	50	500	0.50		30244	0.0546
881-510	227	1	1	568		56649	0.0000
881-52	227	1	5	52		56648	0.0000
881-53	227	1	5	61		56647	0.0000
881-54	227	1	5	70.00		56662	
881-56	227	1	1	182		56659	0.0000
881-58	227	1	1	412		56660	0.0000
882-1	225	10	10	2.85	✓	30221	0.1478
882-105	231	1	6	58.00		50759	0.9553
882-11	225	10	10	4.80	✓	30225	0.1888
882-110	231	1	6	28.39		50760	0.6182
882-160	232	1	10	4.00		37403	0.0000
882-175	232	1	10	35.00		37402	0.0000
882-180	232	1	10	15.00		37401	0.0000
882-1B	225	100	100	2.80		30513	0.1463
882-1P	226	10	10	15.50		35108	0.3998

Item No.	Page No.	Min Qty	Case Qty	List Price	UPC Bar-Coded	UPC 5-Digit 739236	Weight (lbs)
882-2	225	10	10	3.25	✓	30222	0.2426
882-21	225	10	10	5.20	✓	30226	0.2480
882-2B	225	100	100	3.20		30516	0.2310
882-2P	226	10	10	15.75		30517	0.4566
882-3	225	10	10	4.65	✓	30223	0.4513
882-35	225	10	10	7.05	✓	30229	0.5376
882-3B	225	50	50	4.60		30521	0.4311
882-3P	226	10	10	17.00		30522	0.6353
882-4	225	10	10	6.00	✓	30224	0.6256
882-41	225	10	10	8.25	✓	30230	0.5826
882-4B	225	50	50	5.95		30525	0.6112
882-4P	226	10	10	18.25		35109	0.8396
882-94	226	1	1	17.50		30526	0.8520
882-95	226	1	1	23.25		30527	1.0660
882-96	226	1	1	25.00		30528	1.0700
882-98	226	1	1	55.00		30529	2.0330
882-ECPG	232	1	1	85.28	✓	52032	5.0000
882-EH24	232	1	1	18.00	✓	30530	0.3517
882-EH36	232	1	1	20.00	✓	30531	0.6775
882-EH60	232	1	1	26.25	✓	30532	0.5675
882-EHPG	232	1	1	57.50	✓	30533	4.3388
882-EL23	228	1	1	123.50	✓	30534	3.0898
882-EL34	228	1	1	147.50	✓	30535	4.1900
882-EL46	228	1	1	295.00	✓	30536	6.4450
882-ES12	228	1	1	43.25	✓	30537	0.8464
882-ES23	228	1	1	45.00	✓	30538	0.8414
882-ES34	228	1	1	44.00	✓	30539	1.7158
882-ES46	228	1	1	105.50	✓	30540	2.8406
882-TT2	228	1	1	45.00	✓	30541	0.6321
882-TT3	228	1	1	50.00	✓	30542	1.2024
882-TT4	228	1	1	57.75	✓	30543	2.3072
883-AT	167	25	25	3.40	✓	30309	0.6063
883-ATPK	167	8	8	3.54	✓	30309	0.6442
883-PT	167	25	25	3.40	✓	30305	0.7410
883-PTPK	167	8	8	3.54	✓	30305	0.8142
884-ATM	167	24	24	6.50	✓	30318	0.7729
884-ATMPK	167	8	8	6.64	✓	30318	0.8292
884-PTM	167	24	24	6.50	✓	30314	0.9287
884-PTMPK	167	8	8	6.64	✓	30314	0.7813
886-411	171	20	20	5.00	✓	30352	0.4596
886-4A	169	25	25	4.83	✓	30551	0.6734
886-4AM	169	25	25	8.45	✓	35663	0.7249
886-4AMS	169	25	25	8.45	✓	35665	0.7249
886-4AMSPK	169	6	6	8.57	✓	30369	0.7502
886-4APK	169	6	6	4.95	✓	30375	0.7202
886-4AS	169	25	25	4.83	✓	35677	0.5149
886-4AT	167	25	25	5.85	✓	35207	0.8404
886-4ATM	167	25	25	8.84	✓	35205	0.6017
886-4ATMPK	167	8	8	8.96	✓	35205	0.6685
886-4ATMS	167	25	25	8.84	✓	35206	0.8779
886-4ATMSPK	167	8	8	8.96	✓	35206	0.8779
886-4ATPK	167	8	8	5.97	✓	35207	0.8585
886-4ATS	167	25	25	5.85	✓	35208	0.8004
886-4ATSPK	167	8	8	5.97	✓	35208	0.8185
886-4P	169	25	25	4.83	✓	30360	0.6650
886-4PM	169	25	25	8.45	✓	35662	0.7137
886-4PMS	169	25	25	8.45	✓	35664	0.7400
886-4PMSPK	169	6	6	8.57	✓	30368	0.7400
886-4PPK	169	6	6	4.95	✓	30374	0.6651
886-4PS	169	25	25	4.83	✓	35676	0.6650
886-4PT	167	25	25	5.85	✓	35211	0.8404
886-4PTM	167	25	25	8.84	✓	35209	0.8317
886-4PTMPK	167	8	8	8.96	✓	35209	0.9185
886-4PTMS	167	25	25	8.84	✓	35210	0.8217
886-4PTMSPK	167	8	8	8.96	✓	35210	0.8885
886-4PTPK	167	8	8	5.97	✓	35211	0.8404

Numerical Index

CATALOG 2007

NUMERICAL INDEX

NUMERICAL INDEX

NUMERICAL INDEX

NUMERICAL INDEX

NUMERICAL INDEX

Item No.	Page No.	Min Qty	Case Qty	List Price	UPC Bar-Coded	UPC 5-Digit 739236	Weight (lbs)
886-4PTS	167	25	25	5.85	✓	35212	0.7904
886-4PTSPK	167	8	8	5.97	✓	35212	0.7904
886-A	169	20	20	3.00	✓	33926	0.5152
886-APK	169	10	10	3.12	✓	30306	0.5855
886-ATMS	167	25	25	11.44	✓	35213	0.6817
886-ATMSPK	167	8	8	11.56	✓	35213	0.7485
886-ATS	167	25	25	5.85	✓	35214	0.5117
886-ATSPK	167	8	8	5.97	✓	35214	0.5785
886-ER	171	25	25	2.00		30356	0.1922
886-MR	171	20	20	4.40	✓	30344	0.3500
886-P	169	20	20	3.00	✓	30443	0.6806
886-PPK	169	10	10	3.12	✓	30302	0.7007
886-PT30	167	25	25	3.80	✓	35661	0.7327
886-PTM30	167	25	25	8.00	✓	35215	0.9269
886-PTM30PK	167	8	8	8.12	✓	35215	0.9269
886-PTMS	167	25	25	11.44	✓	35216	0.9817
886-PTMSPK	167	8	8	11.56	✓	35216	1.0485
886-PTS	167	25	25	5.85	✓	35217	0.4517
886-PTSPK	167	8	8	5.97	✓	35217	0.5003
886-R	171	20	20	2.75	✓	30342	0.3859
887-AM	169	25	25	6.35	✓	30316	0.7454
887-GAM	168	6	6	18.75	✓	30384	0.7503
887-GATM	168	6	6	19.25	✓	35199	0.7242
887-GPM	168	6	6	18.75	✓	30382	0.6843
887-GPTM	168	6	6	19.25	✓	30383	0.7242
887-GPTMK	168	6	6	29.00	✓	33927	2.5529
887-PM	169	25	25	6.35	✓	30312	0.8320
888-A	169	20	20	3.75	✓	30563	0.4802
888-AM	169	12	12	9.00	✓	35658	0.8402
888-APK	169	10	10	3.88	✓	30336	0.5505
888-ATM	167	25	25	6.12	✓	35218	0.6504
888-ATMPK	167	8	8	6.24	✓	35218	0.6679
888-GPM	168	6	6	25.24	✓	35659	0.9007
888-P	169	20	20	3.75	✓	36513	0.6077
888-PM	169	12	12	9.00	✓	35657	1.0337
888-PPK	169	10	10	3.88	✓	30332	0.6865
888-PTM	167	25	25	6.12	✓	35220	0.7304
888-PTMPK	167	8	8	6.24	✓	35220	0.7485
889-45AM	170	20	20	14.50	✓	30565	1.5700
889-45AMPK	170	10	10	14.63	✓	35221	0.8830
889-45PM	170	20	20	14.50	✓	30566	0.9850
889-45PMPK	170	10	10	14.63	✓	30328	1.1180
889-AOM	169	20	20	10.25	✓	30567	0.9500
889-AOMP	169	6	6	10.38	✓	30324	1.0542
889-POM	169	20	20	10.25	✓	30568	1.0582
889-POMP	169	6	6	10.38	✓	30322	1.6918
890-4BDPK	170	10	10	17.50	✓	30355	0.7419
890-4BPK	170	10	10	10.75	✓	30354	0.8026
890-i42	170	5	5	12.00	✓	30362	3.4103
890-i42B	170	500	500	11.00	✓	30570	3.3200
891-0312A	187	5	5	13.00	✓	31132	0.6400
891-0312P	187	5	5	13.00	✓	31032	0.6814
891-033P	187	5	5	13.75	✓	31033	0.9239
891-0412A	187	5	5	14.00	✓	31142	0.8200
891-0412P	187	5	5	14.00	✓	31042	0.8763
891-043P	187	5	5	15.00	✓	31043	1.1318
891-044P	187	5	5	15.50	✓	31044	1.2410
901	257	100	100	0.80		50761	0.0569
901-10	256	10	100	0.85		50762	0.0585
901-12	256	10	100	0.93		50763	0.0586
901-16	256	10	100	0.97		50764	0.0630
901-20	256	10	100	0.94		50765	0.0635
901-24	256	10	100	0.99		50766	0.0664
901-28	256	10	100	0.98		50767	0.0709
901-32	256	10	100	1.07		50768	0.0730
902	257	50	50	2.35		50769	0.4189

A 10% surcharge will be applied to any item NOT purchased in multiples of the stated Minimum Quantity, except on drop ship orders. Items that are bold in the Min Qty column may NEVER be broken.

Item No.	Page No.	Min Qty	Case Qty	List Price	UPC Bar-Coded	UPC 5-Digit 739236	Weight (lbs)
905	257	1	1	43.88	✓	50770	10.8000
906	257	1	1	61.15	✓	50771	18.6000
910-2	237	25	250	0.28		40806	0.0286
910-2PK2	237	10	10	0.99	✓	40804	0.0795
910-3	237	25	250	0.28		40814	0.0296
910-3PK2	237	10	10	0.99	✓	40812	0.0815
911-2	237	25	250	0.26		40810	0.0286
911-2PK2	237	10	10	0.90	✓	40808	0.0795
911-3	237	25	250	0.28		40818	0.0226
911-3PK2	237	10	10	0.94	✓	40816	0.0676
911-4	237	25	250	0.46		40823	0.0284
911-4PK2	237	10	10	1.25	✓	40822	0.0791
911-6	237	25	250	0.48		40827	0.0297
911-6D	237	25	250	0.72		50778	0.0469
911-6PK2	237	10	10	0.74	✓	40826	0.0520
911-7	237	25	250	0.86		40829	0.0459
911-7PK2	237	10	10	1.05	✓	40828	0.0700
916-2	237	12	120	0.94		40906	0.0359
916-2PK2	237	12	12	1.20	✓	40904	0.0524
916-3	237	12	120	0.94		40914	0.0359
916-3PK2	237	12	12	1.20	✓	40912	0.0552
916-4	237	12	120	0.94		40921	0.0459
916-4PK2	237	12	12	1.20	✓	40920	0.0652
917-2	237	12	120	0.91		40910	0.0429
917-2PK2	237	12	12	1.15	✓	40908	0.0622
917-3	237	12	120	0.91		40918	0.0509
917-3PK2	237	12	12	1.15	✓	40916	0.0702
917-4	237	12	120	1.02		40923	0.0394
917-4PK2	237	12	12	1.39	✓	40922	0.0587
917-6	237	12	120	1.12		40927	0.0694
917-6PK2	237	12	12	1.40	✓	40926	0.0887
920-1W	235	50	500	0.18		40703	0.0151
920-1WPK2	235	10	10	0.61	✓	40702	0.0362
920-2W	235	25	250	0.18		40706	0.0156
920-2WPK2	235	10	10	0.62	✓	40704	0.0463
920-2WPK4	235	1	1	17.14	✓	35649	1.4826
920-3W	235	25	250	0.18		40714	0.0154
920-3WPK2	235	10	10	0.62	✓	40712	0.0459
920-4W	235	20	100	0.43		40721	0.0429
920-4WPK2	235	10	10	1.14	✓	40720	0.1120
921-1W	235	50	500	0.19		40701	0.0152
921-1WPK2	235	10	10	0.63	✓	40700	0.0521
921-2W	235	50	500	0.20		40710	0.0149
921-2WPK2	235	10	10	0.66	✓	40708	0.0483
921-3W	235	50	500	0.22		40718	0.0152
921-3WPK2	235	10	10	0.70	✓	40716	0.0488
921-4W	235	20	100	0.41		40723	0.0429
921-4WPK2	235	10	10	1.16	✓	40722	0.1293
921-5W	235	20	100	0.46		40743	0.0416
921-5WPK2	235	10	10	0.63	✓	40744	0.0541
921-6W	235	20	100	0.39		40727	0.0379
921-6WPK2	235	10	100	0.60	✓	40726	0.0541
921-7W	235	20	100	0.41		40729	0.0349
921-7WPK2	235	10	10	0.62	✓	40728	0.0511
922-5W	235	25	25	0.83		50798	0.1038
922-5WPK2	235	10	10	1.13	✓	40732	0.1091
922-6W	235	25	25	0.83		50799	0.1028
922-6WPK2	235	10	10	1.12	✓	40734	0.1081
926-2	236	12	120	1.05		43006	0.0210
926-2PK2	236	12	12	1.30	✓	43004	0.0404
926-2W	236	12	120	0.70		50801	0.0250
926-3	236	12	120	1.05		43014	0.0250
926-3PK2	236	12	12	1.30	✓	43012	0.0444
926-3W	236	12	120	0.74		50803	0.0250
926-4	236	12	120	1.18		43021	0.0250
926-4PK2	236	12	12	1.45	✓	43020	0.0444

Item No.	Page No.	Min Qty	Case Qty	List Price	UPC Bar-Coded	UPC 5-Digit 739236	Weight (lbs)
926-4W	236	12	120	0.85		50805	0.0330
927-2	236	12	120	1.05		49542	0.0250
927-2PK2	236	12	12	1.35	✓	43008	0.0444
927-2W	236	12	120	0.73		50807	0.0250
927-3	236	12	120	1.06		43018	0.0250
927-3PK2	236	12	12	1.45	✓	43016	0.0444
927-3W	236	12	120	0.74		50809	0.0410
927-4	236	12	120	1.17		43023	0.0250
927-4PK2	236	12	12	1.45	✓	43022	0.0444
927-4W	236	12	120	0.84		50811	0.0260
927-5PK2	236	12	12	2.11	✓	43042	0.0611
927-6	236	12	120	1.76		43027	0.0330
927-6PK2	236	12	12	2.20	✓	43026	0.0541
927-6W	236	12	120	1.01		50813	0.0330
927-7	236	12	120	1.85		43029	0.0340
927-7PK2	236	12	12	2.30	✓	43028	0.0613
927-7W	236	12	120	1.00		50815	0.0410
927-8W	236	12	120	1.83		50816	0.0660
928-12	238	50	500	0.23		50817	0.0067
928-125	238	50	500	0.23		50818	0.0055
928-13	238	50	500	0.23		50819	0.0064
928-2	238	50	500	0.23		50820	0.0063
928-2PK4	238	1	1	75.17	✓	51897	2.2379
928-3	238	50	500	0.23		50821	0.0116
928-4	238	25	200	0.44		50822	0.0069
940-10	271	6	6	11.56		50823	2.4522
940-10PK1	271	10	10	13.10	✓	60012	2.5268
940-11	271	6	6	11.56		50824	2.5422
940-12	271	6	6	11.56		50825	2.4922
940-13	271	6	6	11.56		50826	2.6082
948	273	12	60	4.49		50827	0.2380
948-EX	273	12	120	1.75		50828	0.3126
948-P	273	12	12	5.09		50829	0.2382
948PK2	273	10	10	5.56	✓	60320	0.2514
948-PPK2	273	10	10	6.46	✓	60326	0.2514
948-W	273	1	12	7.12		60340	0.2380
949	273	12	120	1.58		50831	0.1427
949-06	273	10	10	5.16		50832	0.2471
949-06PK2	273	10	10	6.45	✓	60506	0.2401
949-OK09PK2	273	10	10	4.35	✓	60479	0.2893
949-OK09PPK2	273	10	10	9.85	✓	60480	0.2943
949-1	273	12	120	1.19		50833	0.1427
949-10	273	1	10	4.90		60510	0.3324
949-12	273	1	10	5.25		50835	0.3329
949-12PK2	273	10	10	6.56	✓	60512	0.3523
949-1P	273	12	120	2.46		50836	0.1427
949-1PK2	273	10	10	1.56	✓	60470	0.1641
949-1PPK2	273	10	10	3.10	✓	60476	0.1641
949-21	273	1	10	7.10		60521	0.6310
949-CP	273	12	120	2.83		50838	0.1427
949-F	273	1	25	3.44		60350	0.1526
949-K09	273	1	1	3.69		50840	0.2281
949-K09P	273	1	1	7.88		50841	0.2481
949-K09PK2	273	10	10	4.39	✓	60429	0.2563
949-K09PPK2	273	10	10	9.85	✓	60430	0.2763
949-K12	273	1	1	5.86		50842	0.2684
949-K12PK2	273	10	10	7.35	✓	60432	0.2963
949-P	273	1	12	2.66		50843	0.1426
949PK2	273	10	10	2.15	✓	60420	0.1641
949-PPK2	273	10	10	3.22	✓	60426	0.1641
952	272	1	24	21.06		50844	0.9731
952-P	272	1	6	22.15		50845	0.9884
952-PK1	272	6	6	24.95	✓	61280	1.0750
952-PPK1	272	6	6	23.85	✓	61286	1.0750
952-V	272	1	12	17.20		62282	0.6032
953	271	1	6	30.35	✓	50847	3.7755

Item No.	Page No.	Min Qty	Case Qty	List Price	UPC Bar-Coded	UPC 5-Digit 739236	Weight (lbs)
953-12	271	1	6	30.35		50848	3.8158
953-12P	271	1	6	33.60	✓	50849	3.8158
953-P	271	1	6	33.60	✓	50850	3.7755
954	272	1	24	19.95		50851	0.9400
954-P	272	1	6	21.50		50852	0.9553
954-PPK1	272	6	6	22.80	✓	61230	1.0419
954-PPK1	272	6	6	23.05	✓	61236	1.0419
954-V	272	1	24	16.95		62232	0.5701
955	271	1	6	30.00	✓	50854	3.7423
955-12	271	1	6	30.00	✓	50855	3.7827
961-20	298	24	24	2.38		50858	0.1617
961-20150	239	1	25	2.84	✓	50859	0.1373
961-20155	239	1	25	3.08	✓	50860	0.0485
961-20158	239	1	25	3.08	✓	50861	0.0485
961-22	298	24	24	2.90		50864	0.2617
961-30	298	6	6	9.28		50865	0.6736
961-32	298	1	12	16.16		50866	0.2745
961-34	298	1	12	16.16		50867	0.6495
961-50	298	10	160	3.90		50868	0.2813
961-6	239	25	25	1.30		50869	0.0600
961-7	239	25	25	1.50		50870	0.1287
962-4	299	12	432	1.68		50871	0.0830
962-41	299	12	432	1.68		50872	0.0830
962-42	299	12	432	1.68		50873	0.0830
962-43	299	12	432	1.68		50874	0.0830
963-01	294	24	240	2.28		50875	0.0144
963-05	296	5	5	12.63		50876	5.2760
963-08	300	12	12	7.85		50878	2.1820
963-15PK2	296	20	20	12.78		51701	1.0020
965-01	297	1	30	2.12		50879	0.1898
965-02	297	1	30	2.16		50880	0.2103
965-04	297	1	30	2.12		50881	0.2248
965-06	297	1	30	2.12		50882	0.2513
965-204	297	25	25	1.47		50883	0.2000
965-208	297	25	25	2.15		50884	0.3140
965-212	297	25	25	2.78		50885	0.3800
965-804	297	25	25	2.32		50886	0.2520
965-808	297	25	25	2.77		50887	0.4160
965-812	297	25	25	2.99		50888	0.4240
968-04	297	8	8	8.77		50889	1.9270
970-112	310	20	20	5.05		30212	0.5952
970-117	310	12	12	8.51		50891	1.3920
970-208	310	12	12	18.90		30208	0.7500
970-214	310	12	12	23.70		30214	1.7670
972-10	239	1	10	8.61	✓	50894	0.5353
972-100	238	1	12	8.06	✓	50895	0.1319
972-10B	239	50	50	8.08		50896	0.5209
972-15	239	1	10	15.37	✓	50897	0.6496
972-15B	239	50	50	14.94		50898	0.6352
972-20	239	1	10	8.46	✓	50899	0.7796
972-30	239	1	10	13.97	✓	50900	0.6816
972-30B	239	50	50	13.00		50901	0.6672
972-35	239	1	10	18.88	✓	50902	0.8696
972-35B	239	50	50	18.01		50903	0.8552
974-60100	240	1	20	6.64	✓	50904	0.2689
974-60102	240	1	12	4.48	✓	50906	0.1920
974-60105	240	6	120	2.05		50907	0.0397
974-60106	240	10	1000	0.16		50908	0.0007
974-60116	255	12	120	0.87		50909	0.0549
974-60205	239	3	24	1.23		50911	0.0234
974-60300	240	1	6	14.89		50913	0.5823
974-60304	240	1	25	5.21	✓	50914	0.2038
974-60305	240	25	25	4.76		50915	0.2027
974-60306	240	1	25	5.43	✓	50916	0.2651
974-60307	240	25	25	5.30		50917	0.2627
974-60308	240	1	25	6.16	✓	50918	0.4074

NUMERICAL INDEX

NUMERICAL INDEX

NUMERICAL INDEX

NUMERICAL INDEX

NUMERICAL INDEX

Numerical Index

CATALOG 2007

Item No.	Page No.	Min Qty	Case Qty	List Price	UPC Bar-Coded	UPC 5-Digit 739236	Weight (lbs)
974-60309	240	25	25	5.74		50919	0.3979
974-60310	240	1	10	3.16	✓	50920	0.1215
974-60315	240	1	10	29.70	✓	50921	0.9689
980-5	252	100	100	1.68		50453	0.0825
980-6	252	100	100	1.95		50926	0.0925
980-8	252	100	100	1.96		50927	0.1425
981-5	252	100	100	1.62		50928	0.0822
981-6	252	100	100	1.64		50929	0.1025
985-5	252	100	100	0.63		50930	0.0542
985-6	252	100	100	0.89		50931	0.0625
985-8	252	100	100	1.23		50932	0.0725
986-6	252	100	100	0.63		50933	0.0525
988-6	252	100	100	0.36		50934	0.0290
990-20385	252	25	300	0.42		50935	0.0095
990-6	252	100	1000	0.36		50936	0.0066
990-7	252	100	1000	0.41		50937	0.0086
991-6	252	100	1000	0.12		50938	0.0058
995-20320	252	25	200	0.35		50939	0.0097
995-20330	252	25	200	0.36		50940	0.0111
995-20335	252	25	200	0.35		50941	0.0151
995-20340	252	25	200	0.35		50942	0.0093
995-5	252	100	1000	0.16		50943	0.0086
995-6	252	100	1000	0.16		50944	0.0106
995-8	252	100	1000	0.21		50945	0.0148
996-6	252	100	1000	0.09		50946	0.0058
996-8	252	100	1000	0.13		50947	0.0078

NUMERICAL INDEX

NUMERICAL INDEX

NUMERICAL INDEX

NUMERICAL INDEX

NUMERICAL INDEX

Try Me Packs



Item No.	Description	Contents Description
SUPPORT		
X1501	Sioux Strap, ivory	10 × 551-2C
X1502	TouchDown	5 × 550-11
X1502combo	TouchDown combo	3 × 550-11 1 × 550-20
X1503	Tube Talon	20 × 555-2
X1505	Suspensulator	5 × 558-E2
X1505SC	Suspensulator in stadium cup	5 × 558-E2
X1506	Tomahawk	1 × 535-14
X1507	Padlock	5 × 551-P2
X1508	Pipe Eye	5 × 558-M2
X1508SC	Pipe Eye in stadium cup	5 × 558-M2
X1509	Sioux Strap	5 × 551-2
X1510	Touchdown II	1 × 550-20
X1511	Twin Talon	5 × 555-23
X1511combo	Twin Talon combo	4 × 555-23 2 × 555-45B
X1511comboSC	Twin Talon combo in stadium cup	4 × 555-23 2 × 555-45B
X1512	Copper Star	2 × 612-2
X1513	Hangs Tuff Jr.	4 × 553-3W
X1514	Hangs Tuff	4 × 553-7W
X1515	Sidewinder	1 × 550-MP2
X151624	Universal Slider Bracket	2 × 522-1624, 522-2424
X1517	ZipStick, white	1 × 553-014W
X1517A	ZipStick, black	1 × 553-014B
X1518	Pipe Titan	1 × 570-20
X1519	Grid Iron	1 × 571-145
X1521	Secure-All Bracket	4 × 521-851
X1523	Power Bar	4 × 523-2424
X1525	Square O tube hanger	4 × 505-24
X1526	Stick-Em Up	1 × 549-712
X1527	Power Bar with all accessories	4 × 523-2424 1 × 523-01, 523-1, 523-31, 523-32, 523-33, 523-34, 550-20, 574-72
X1528	Power Bar with drop ear elbow	1 × 523-24, 616-2E, screws
X1545	Twin Talon	1 × 555-45B
X1556	Pick Up Talon	25 × 556-2
X1556C	Pick Up Talon, ivory	25 × 556-2C
X1556CSC	Pick Up Talon, ivory in stadium cup	25 × 556-2C
X1556SC	Pick Up Talon in stadium cup	25 × 556-2
X1557	Suspension Clamp	5 × 557-2
X1557SC	Suspension Clamp in stadium cup	5 × 557-2
X1558	Tube Insulator	5 × 558-2
X1558SC	Tube Insulator in stadium cup	5 × 558-2
X1559	Tube Clamp	5 × 559-2
X1559SC	Tube Clamp in stadium cup	5 × 559-2
X1560	Fire Retardant (E84) Suspension Clamp	2 × 557F2
X1561	Fire Retardant (E84) Pipe Eye	2 × 558FM2
X1562	Fire Retardant (E84) Tube Clamp	2 × 559F2
X1563	Pipe Eye Suspension Bracket	1 × 521-558, 558-M2, 558-M3, 558-M4
X1565	Fire Fighter (E84) variety pack	1 × 523F2424, 558FM2, 557F2, 521-558, 559F3, 550F20, 550F11
X1566	Fire Fighter (E84) TouchDown II with Strut Foot	1 × 550F2T
X1566SC	Fire Fighter (E84) TouchDown II with Strut Foot	1 × 550F2T
X1567	Fire Fighter (E84) TouchDown & TouchDown II combo	1 × 550F11, 550F20

Item No.	Description	Contents Description
X1567SC	Fire Fighter (E84) TouchDown I & TouchDown II combo in stadium cup	1 x 550F11, 550F20
X1568	TouchDown II Strut Clamp	1 x 550-2T
X1568SC	TouchDown II Strut Clamp in stadium cup	1 x 550-2T
X1569	Fire Fighter (E84) Power Bar	2 x 523F2424
X1570	TouchDown Beam Clamp	2 x 550-11E & 550-20E, 1-550-20E
SUPPLY		
X1620	Sweat Fittings	1 x 612-2, 505-29, 614-2, 613-57, 609-L246, 608-L246, 622-M06, 609-L263A, 609-L263X, 609-L263Y
X1640	PEX Fittings	2 x 649X2 1 x 641X222, 642X2, 645X2, 632X222, 630X246, 643X2, 647X2E, 632X263, 638X208, 632X263X, 632X263Y, 644X2
X1660	CPVC Fittings	1 x 647-C2E, 646-C2, 551-2C, 632-C283, 637-C20, 630-C248, 632-C263X, 632-C263Y
X1670	Full Slip Brass Adapter	2 x 614-22C
X1672	Replace-A-Valve	1 x 600-204CV
X1673	Tub Spout Elbow	1 x 613-67, 928-2
DRAINAGE		
X1293combo	Grip Tip, Test Plug and Cap	2 x 881-12, 880-82
X1298	Test Titan	1 x 882-3
X1299	Test Titan, for Cleanout	1 x 882-35
X1883	TKO, PVC with Plumb Perfect	1 x 883-PT, 425-PB
X1883A	TKO, ABS with Plumb Perfect	1 x 883-AT, 425-PB
X1884A	TKO, ABS Metal Ring with Plumb Perfect	1 x 884-ATM, 425-PB
X1884P	TKO, PVC Metal Ring with Plumb Perfect	1 x 884-PTM, 425-PB
X1886	Raise-A-Ring with Plumb Perfect	1 x 886-R, 427-PB
X1886M	Ringer with Plumb Perfect	1 x 886-MR, 425-PB
X1887A	Push-Tite TKO, ABS with Plumb Perfect	1 x 887-GATM, 425-PB
X1887P	Push-Tite TKO, PVC with Plumb Perfect	1 x 887-GPTM, 425-PB
X1889A	Drop Kick, ABS with Plumb Perfect	1 x 889-45AM, 425-PB
X1889P	Drop Kick, PVC with Plumb Perfect	1 x 889-45PM, 425-PB
X1891A	Shower Pan Drain with SS strainer, 2" ABS	1 x 821-2A
X1891P	Shower Pan Drain with SS strainer, 2" PVC	1 x 821-2P
X1892A	Solvent Weld Shower Drain with SS strainer, 2" ABS	1 x 825-2A
X1892P	Solvent Weld Shower Drain with SS strainer, 2" PVC	1 x 825-2P
SPECIALTIES		
X1291	Drip-Free Washer	3 x 290-20301, 290-20311, 290-20313, 290-20381
X1291SC	Drip-Free Washer in stadium cup	3 x 290-20301, 290-20311, 290-20313, 290-20381
X1292	Wedge-It	2 x 460-10, 460-20
X1295	Dry Seal Pipe Collar	5 x 928-2
X1295SC	Dry Seal Pipe Collar in stadium cup	5 x 928-2
X1296	Shower WallNut	1 x 614-8L, 622-L08, 616-02C, 523-2414
X1401	Plumb Perfect	6 x 425, 430
X1901	Trim Tite	5 x 920-2W
X1902	No Putty Gasket	2 x 290-20320, 290-20322, 290-20324
X1902SC	No Putty Gasket in stadium cup	2 x 290-20320, 290-20322, 290-20324
TOOLS		
X1300	Handsaws	1 x 300-12, 301-062



Reference Data

Nominal Tube Size	O.D. Size (in.)	Wall Thickness (in.)	Weight of Tube (lbs/ft)	Weight of Pipe Full of Water (lbs/ft)
SCHEDULE 40 STEEL				
1/8"	.405	.068	.2	.4
1/4"	.540	.088	.4	.5
3/8"	.675	.091	.6	.7
1/2"	.840	.109	.8	.9
3/4"	1.050	.113	1.1	1.3
1"	1.315	.133	1.7	2.1
1 1/4"	1.660	.140	2.3	2.9
1 1/2"	1.900	.145	2.7	3.6
2"	2.375	.154	3.6	5.0
2 1/2"	2.875	.203	5.8	7.9
3"	3.500	.216	7.6	10.8
3 1/2"	4.000	.226	9.1	13.4
4"	4.500	.237	10.8	16.3
SCHEDULE 40 PVC				
1/8"	.405	.068	.04	.06
1/4"	.540	.088	.07	.11
3/8"	.675	.091	.10	.18
1/2"	.840	.109	.15	.25
3/4"	1.050	.113	.20	.40
1"	1.315	.133	.30	.70
1 1/4"	1.660	.140	.40	1.00
1 1/2"	1.900	.145	.50	1.40
2"	2.375	.154	.60	2.00
2 1/2"	2.875	.230	1.00	3.10
3"	3.500	.216	1.30	4.50
3 1/2"	4.000	.226	1.60	5.90
4"	4.500	.237	1.90	7.40
SCHEDULE 40 CPVC				
1/4"	.540	.088	.09	.12
1/2"	.840	.109	.19	.28
3/4"	1.050	.113	.25	.43
1"	1.315	.133	.38	.76
1 1/4"	1.660	.140	.51	1.08
1 1/2"	1.900	.145	.61	1.49
2"	2.375	.154	.82	2.12
2 1/2"	2.875	.230	1.29	3.29
3"	3.500	.216	1.69	4.75
4"	4.500	.237	2.33	7.68

Nominal Tube Size	O.D. Size (in.)	Wall Thickness (in.)	Weight of Tube (lbs/ft)	Weight of Pipe Full of Water (lbs/ft)
SCHEDULE 80 STEEL				
1/8"	.405	.095	.3	.4
1/4"	.540	.119	.5	.6
3/8"	.675	.126	.7	.8
1/2"	.840	.147	1.1	1.2
3/4"	1.050	.154	1.5	1.7
1"	1.315	.179	2.2	2.5
1 1/4"	1.660	.191	3.0	3.5
1 1/2"	1.900	.200	3.6	4.3
2"	2.375	.218	5.0	6.3
2 1/2"	2.875	.276	7.6	9.4
3"	3.500	.300	10.2	13.0
3 1/2"	4.000	.318	12.5	16.3
4"	4.500	.337	15.0	20.0
SCHEDULE 80 PVC				
1/8"	.405	.095	.05	.06
1/4"	.540	.119	.09	.12
3/8"	.675	.126	.10	.16
1/2"	.840	.147	.10	.20
3/4"	1.050	.154	.20	.40
1"	1.315	.179	.40	.70
1 1/4"	1.660	.191	.50	1.00
1 1/2"	1.900	.200	.60	1.30
2"	2.375	.218	.90	2.20
2 1/2"	2.875	.276	1.30	3.10
3"	3.500	.300	1.80	4.60
3 1/2"	4.000	.318	2.20	6.00
4"	4.500	.337	2.60	7.60
SCHEDULE 80 CPVC				
1/4"	.540	.119	.12	.16
1/2"	.840	.147	.24	.31
3/4"	1.050	.154	.33	.48
1"	1.315	.179	.49	.85
1 1/4"	1.660	.191	.67	1.18
1 1/2"	1.900	.200	.81	1.61
2"	2.375	.218	1.09	2.26
2 1/2"	2.875	.276	1.65	3.49
3"	3.500	.300	2.21	5.02
4"	4.500	.337	3.23	8.08
SCHEDULE 80 POLYPRO				
1/2"	.840	.147	.14	.19
3/4"	1.050	.154	.19	.33
1"	1.315	.179	.27	.49
1 1/4"	1.660	.191	.38	.85
1 1/2"	1.900	.200	.45	1.18
2"	2.375	.218	.62	1.61
SCHEDULE 80 PVDF				
1/2"	.840	.147	.24	.31
3/4"	1.050	.154	.33	.48
1"	1.315	.179	.49	.85
1 1/4"	1.660	.191	.67	1.18
1 1/2"	1.900	.200	.81	1.61
2"	2.375	.218	1.13	2.26

Nominal Tube Size	O.D. Size (in.)	Wall Thickness (in.)	Weight of Tube (lbs/ft)	Weight of Pipe Full of Water (lbs/ft)
COPPER TYPE K				
¼"	.375	.035	.14	.17
⅜"	.500	.049	.27	.32
½"	.625	.049	.34	.43
⅝"	.750	.049	.42	.56
¾"	.875	.065	.64	.83
1"	1.125	.065	.84	1.18
1¼"	1.375	.065	1.04	1.57
1½"	1.625	.072	1.36	2.10
2"	2.125	.083	2.06	3.37
2½"	2.625	.095	2.92	4.92
3"	3.125	.109	4.00	6.96
3½"	3.625	.120	5.12	9.02
4"	4.125	.134	6.51	11.57
COPPER TYPE L				
¼"	.375	.030	.12	.15
⅜"	.500	.035	.20	.26
½"	.625	.040	.28	.38
⅝"	.750	.042	.36	.51
¾"	.875	.045	.45	.66
1"	1.125	.050	.65	1.01
1¼"	1.375	.055	.88	1.42
1½"	1.625	.060	1.14	1.91
2"	2.125	.070	1.75	3.09
2½"	2.625	.080	2.48	4.54
3"	3.125	.090	3.33	6.28
3½"	3.625	.100	4.29	8.28
4"	4.125	.110	5.38	10.57
COPPER TYPE M				
½"	.625	.028	.204	.314
¾"	.875	.032	.328	.551
1"	1.125	.035	.465	.843
1¼"	1.375	.042	.682	1.25
1½"	1.625	.049	.940	1.73
2"	2.125	.058	1.460	2.83
2½"	2.625	.065	2.030	4.14
3"	3.125	.072	2.680	5.70
3½"	3.625	.083	3.580	7.64
4"	4.125	.095	4.660	9.83
COPPER TYPE DWV				
1¼"	1.375	.040	.65	1.22
1½"	1.625	.042	.81	1.62
2"	2.125	.042	1.07	2.48
3"	3.125	.045	1.69	4.81
4"	4.125	.058	2.87	7.88

Nominal Tube Size	O.D. Size (in.)	Wall Thickness (in.)	Weight of Tube (lbs/ft)	Weight of Pipe Full of Water (lbs/ft)
CAST IRON EXTRA WEIGHT				
2"	2.38	.190	5.0	6.6
3"	3.50	.250	9.0	12.7
4"	4.50	.250	12.0	18.5
CAST IRON SERVICE WEIGHT				
2"	2.25	.17	4	5.5
3"	3.25	.17	6	9.4
4"	4.25	.18	8	14.2
NO-HUB CAST IRON				
1½"	1.90	.16	2.7	6.2
2"	2.35	.16	3.6	8.6
3"	3.35	.16	5.2	13.5
4"	4.38	.19	7.4	20.2

Hanger Spacing

Nominal Tubing Size	Maximum Span
½"	5'
¾"	5'
1"	6'
1¼"	7'
1½"	8'
2"	8'
2½"	9'
3"	10'
3½"	11'
4"	12'

- 1 cubic ft of water weighs 62.41 lbs.
- 1 cubic meter of water weighs 100 kg.
- 1 gallon (US) of water weighs 8.335 lbs.
- 1 liter of water weighs 1 kg.

Copper water tube and copper sweat fittings are referenced by their nominal (nom) size, which approximates the inside diameter (I.D.) waterway of the tube (½" nom, ¾" nom, etc.). Compression fittings are referenced by the outside diameter (O.D.) of the tube they connect to (⅝" O.D., ⅞" O.D., etc.). Copper water tube is manufactured to conform to ASTM Standard B 88.

Representatives

CATALOG 2007

COMPANY	PHONE	FAX	WEB SITE	TERRITORY
1 Badgerland Trading Company	262-827-3177	262-827-3176	badgerlandtrading.com	upper MI, WI
2 Barger & Associates	757-873-4574	757-873-9530	barger-assoc.com	VA
3 Battersby Danielson & Assoc.	317-867-3799	317-867-3499	battersbydanielson.com	IN
4 Bobier Sales, Inc.	602-304-0001	602-304-0005	bobiersales.com	AZ
5 Bull's i Sales	800-888-8391	913-649-8594	bullsisales.com	IA, NE
6 Cathell & Associates	410-323-9881	410-433-1548		DE, MD, northern VA
7 Champions Marketing	281-351-1009	281-351-1125		LA, TX
8 Cope-Wardell-Ammon Associates	610-485-2828	610-485-7171	cwaassociates.com	southern NJ, eastern PA
9 Dellon Sales Company	516-625-2626	516-625-3030	dellonco.com	northern NJ, NYC, Long Island
10 Exceptional Product Sales	586-286-3240	586-286-3241		lower MI
11 Gordon & Associates	503-282-5711	503-282-5715	gordonandassoc.com	AK, northern ID, OR, WA
12 GT Marketing	801-942-3711	801-942-5646		ID, UT
13 J. Barber Sales	925-743-1258	925-743-1945		northern CA, NV
14 John Tew & Associates	919-735-4195	919-735-3127	jtew.com	NC, SC
15 L & R Associates	412-461-2476	412-461-2476	landrassocinc.com	western PA, WV
16 Lowder Sales, Inc.	800-221-5650	888-254-0500	lowdersales.com	KY, OH
17 McKee-Nix and Associates	770-934-8061	770-934-3233		GA, TN
18 MR Associates Inc.	314-962-8960	314-962-2104	mrassocinc.com	IL, eastern MO
19 Northland Reps	952-854-3905	952-854-5210	northlandreps.com	MN, ND, SD
20 NSC Marketing	405-848-3100	405-848-3101		AR, OK
21 RSL Sales Associates	800-538-4792	352-237-0438	rslsales.com	FL
22 Serpa Corporation	781-769-9988	781-769-9985	theserpacorp.com	CT, MA, ME, NH, RI, VT
23 SFE Enterprises	816-322-2206	816-322-5560		KS, western MO
24 T. Matera & Associates	630-769-0400	630-769-0401	tmatera.com	northern IL
25 Tim Morales & Associates, Inc.	866-471-8333	866-471-8339	timmorales.com	AL, FL panhandle, MS
26 TM Sales	303-375-1515	303-375-0305	tmsalesinc.com	CO, MT, western NE, WY
27 Trico Sales, Inc.	909-964-9503	909-625-1264		southern CA, HI, Las Vegas
28 Twin D Associates	800-522-3523	518-464-3410	twindassociates.com	Upstate NY
29 W W Sales Company	505-878-0636	505-878-0638		NM, TX panhandle
CANADA/PUERTO RICO				
30 Burton Purcell	506-634-1100			NL, NB, NS, PE, QC
31 JSA Sales Inc.	604-525-4774	604-525-4355	jsasales.com	BC
32 Key West Marketing	204-774-2566	204-772-6221		MB
33 NewGen Sales, Ltd.	905-895-5999	905-895-5903		ON
34 Preferred Sales	403-547-5237	403-547-5238		AB
35 Reliable Sales	787-752-6690	787-752-6920		PR
36 Westcan Mechanical Sales	306-539-3397	306-638-6258		SK

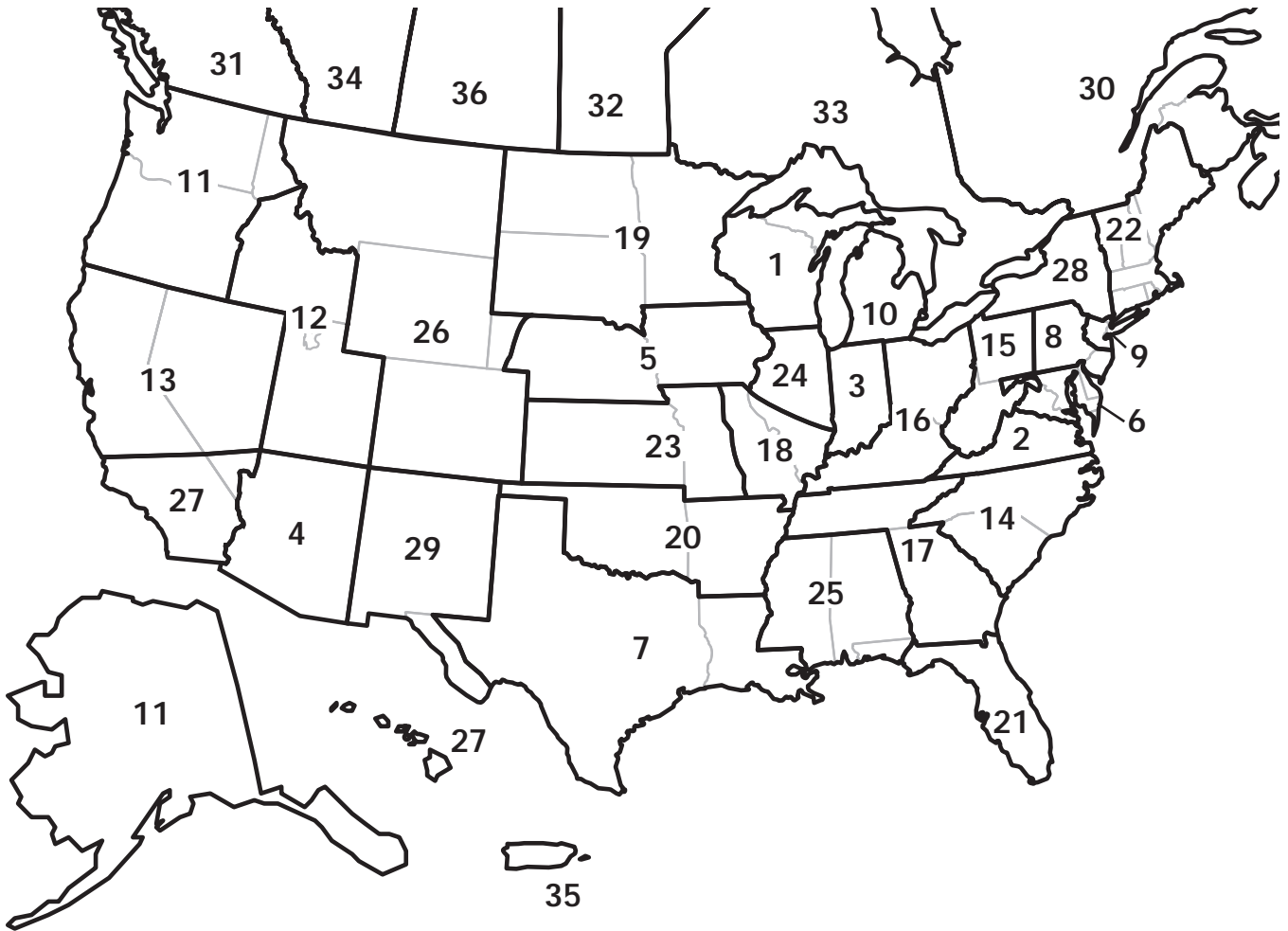

Visit siouxchief.com to get complete information about every Sioux Chief Representative.



Find Any Rep

by geographical area...
by clicking on the map.

by name...
by selecting their name from the drop-down menu and clicking on the Search button.



Rep Information

Rep logo
Map of area represented
Contact names
Address
Phone
Fax
Web site
Email

Sioux Chief Order Form

Please COPY this form for future orders

DATE _____
PAGE _____ OF _____

INSTRUCTIONS

- 1 Fill in all Bill to and Ship to information.
- 2 Complete one line for each item ordered and fully extend for item total. Add all lines for order total.
- 3 Fax or mail page(s) to factory, representative, or wholesaler.

BILL TO new address

Qualified wholesale distributors only		
Purchase order no.		
Contact name		
Company		
Street address		
City		
State	Zip	
Phone	Fax	
Special instructions		

SHIP TO new address

Leave blank if same as "bill to"		
Purchase order no.		
Contact name		
Company		
Street address		
City		
State	Zip	
Phone	Fax	
Special instructions		

ORDER

Item No.	Description	Qty.	List Price Each	List Price Total	Mult.	Net Price Total
1						
2						
3						
4						
5						
6						
7						
8						
9						
10						
11						
12						
13						
14						
15						
Signature	Date	Order Totals				

See page 8 of this catalog for our Terms & Conditions.

Sioux Chief Manufacturing Company, Inc.
 P.O. Box 397 24110 South Peculiar Drive
 Peculiar, MO 64078 USA
 tel: 1-800-821-3944 • 816-779-6104
 fax: 1-800-758-5950 • 816-758-5950
 www.siouxchief.com
 info@siouxchief.com



Company History

Sioux Chief Mfg. Co. Inc. was founded and incorporated in August, 1957 by the late Martin E. "Ed" Ismert, Jr. in an attempt to smooth the boom-bust housing cycle that his plumbing wholesale supply company experienced. Sioux Chief got its start during the late '50s by packaging specialty fasteners and other items geared toward residential plumbing jobs. In the early '60s, Ed borrowed the idea of spinning copper tube closed for simple air chambers and adapted it for stub outs which could be used by plumbers. This preformed copper tube saved plumbers from sweat soldering tube caps onto their copper tube for water shock and test-off purposes. By 1975 a heavy emphasis on sales and new product development began when Ed's two eldest sons purchased the corporation and took over operations. Since then Sioux Chief has introduced a wide range of innovative products.

Sioux Chief began its operations in a 3,000 square foot third floor area of Double I Supply, a plumbing wholesaler in the Kansas City, Kansas west river bottoms, from 1957 to 1967. After moving to Kansas City, Missouri from 1967 to 1969, Sioux Chief grew into a 10,000 square foot building in Grandview, Missouri from 1970 until 1983. In 1983, the corporation purchased its own building for the first time, a 23,000 square foot plant, warehouse, and office south of Peculiar, Missouri. Today this plant-warehouse-office has grown to occupy more than 300,000 square feet on 140 acres.



Mission Statement

Sioux Chief Manufacturing's primary purpose is to provide better value to our customer by offering innovative products of quality and superior customer service to the professional plumbing and mechanical contractor through qualified distributors. We do this by going about our daily duty safely, conscious of our best quality, and in our most productive manner. At Sioux Chief, our customer is our chief. The managers here do not pay the wages, they only route the revenue for growth. It is our customer who pays our wages with their continued good will and loyalty. We will never assume that loyalty. We strive every day to improve quality and service for our customer, and we put all of our hearts, minds, and bodies into this improvement.

The Sioux Chief Name

Sioux Chief's founder, Martin E. "Ed" Ismert Jr., was greatly interested in Western Americana. Ed's father, Martin Sr., was a collector and Midwest authority of Western and Native American artifacts in the '30s, '40s, and '50s. When the time came to name his new company, it did not take Ed long, as he had learned from his father all about the Sioux Indian Nation. The Sioux Nation were a very proud and resolute people that, while being fierce and competitive, held in highest regard the family, the Earth, and especially Wakan Tanka, the Great Spirit. Ed commissioned his brother Bud, an artist who studied under Thomas Hart Benton, to draw the "Young Determined Sioux Chief" in full ceremonial dress as the logo for his young determined company. Sioux Chief Manufacturing, being named and patterned after such a distinctive people would put forth an image not easily forgotten.





Sioux Chief Manufacturing Company, Inc.

P.O. Box 397 24110 South Peculiar Drive

Peculiar, Missouri 64078 USA

tel: 1-800-821-3944 or 816-779-6104

fax: 1-800-758-5950 or 816-758-5950

web: www.siouxchief.com

email: info@siouxchief.com

© 2007 Sioux Chief Manufacturing Company, Inc.

